

Tarifa 2017

BARRAS DE CORTINAS
PANELES JAPONESES
MOTORIZADOS
ACCESORIOS
ESTORES
GALERÍAS
RIELES



Marvent

SOLUCIONES PARA DECORAR VENTANAS

Presentación del proyecto

PRESENTATION OF THE PROJECT / PRÉSENTATION DU PROJET

 **Estimado Amigo:**

Agradecerle en primer lugar la confianza y colaboración que han depositado en *Marvent*. Gracias a ella, durante todo el 2017 podemos celebrar nuestro 3º aniversario, el cual se lo debemos en gran parte a usted. Ahora deseamos poner en sus manos nuestro nuevo catálogo SOLUTIONS 2017 que le hacemos llegar con la misma ilusión e intensidad que cuando empezamos.

En él, encontrará toda nuestra gama de barras y rieles decorativos, rieles técnicos, estores, paneles japonés, sistemas motorizados, galerías y todo tipo de accesorios para confeccionar cortinas como ollaos, cintas, etc para dar solución a todas las necesidades decorativas y técnicas. Hemos incluido varias novedades tanto en la gama decorativa como en la gama técnica en nuestra intención de ofrecerle la oferta más completa posible.

Durante estos años, el equipo de *MARVENT SYSTEM S.L.* ha trabajado muy duro desde todos sus departamentos para ofrecerle la mejor relación calidad-precio del mercado, enviando el pedido en el plazo que usted necesita y prestando mucha atención a todos los detalles. El resultado de este esfuerzo es que nos hemos consolidado como una empresa líder en el sector gracias a que contamos con una amplísima gama de soluciones decorativas y técnicas, prestando muchísima atención a nuestro servicio. Nuestro stock permanente, nos permite preparar los pedidos de forma rápida. Ofrecemos un servicio de personalización de pedidos, para que usted no tenga que preocuparse más que de instalarlo.

Por todo ello, deseamos Agradecerle su Confianza, porque sin usted este proyecto no sería posible. Ser su proveedor nos llena de orgullo, sobre todo en un tiempo muy difícil donde las soluciones eficaces son necesarias para la evolución de todos nosotros. Estamos a su entera disposición. Tanto nuestro personal cómo nuestros departamentos, están volcados en usted. Queremos que su decisión de confiar en *Marvent* sea su mejor decisión.

Es un verdadero placer contar con su confianza.



 **Dear Friend:**

Thank you firstly for the trust and collaboration you have placed in *Marvent*. Thanks to it, throughout 2017 we can celebrate our 3th anniversary, which we owe mainly to you. Now we want to put into your hands our new catalogue SOLUTIONS 2017 with the same illusion and intensity as when we started.

In it, you will find all our range of poles and decorative rails, technical rails, blinds, Japanese panels, motorized systems, pelmets and all kinds of accessories to make curtains like loops, ribbons, etc. to give solution to all the decorative and technical needs. We have included several innovations both in the decorative range and in the technical range in our intention to offer you the most complete offer possible.

During these years, the Management of *MARVENT SYSTEM S.L.* has worked very hard from all departments to offer you the best value in the market, sending the order in the time you need and paying close attention to all the details. The result of this effort is that we have consolidated as a leading company in the sector thanks to our wide range of decorative and technical solutions, and the extreme care in our service. Our permanent stock allows us to prepare orders quickly. We offer a service of customization of orders, and if requested, we personalize our articles so that you do not have to worry more than to install it once received. Our logistics, since we export to more than 65 countries, also allows us to be very quick in time-shipments.

For all this, we wish to thank you for your confidence, because without you this project would not be possible. Being your supplier fills us with pride, especially in a very difficult time where effective solutions are necessary for the evolution of all of us. We are at your disposal. Both our staff and our departments are focused on you. We want your choice to trust *Marvent* to be your best decision.

It is a real pleasure to count on your confidence.

 **Cher ami:**

Nous vous remercions de la confiance et d'abord la collaboration que vous avez placée dans *Marvent*. C'est grâce à cela, nous pouvons célébrer notre 2017 TOUTE 3e anniversaire qui nous devons principalement à vous. Maintenant, nous voulons mettre en vos mains nos nouvelles 2017 catalogue SOLUTIONS avec la même illusion et l'intensité que nous avons commencé.

Dans ce document, vous trouverez toute notre gamme de tringles et de rails décoratifs, rails techniques, stores bateaux, panneaux japonais, des systèmes motorisés, cantonnières et toutes sortes d'accessoires comme des rideaux pour faire des boucles, rubans, etc. pour donner une solution à l'ensemble des besoins décoratifs et techniques. Nous avons plusieurs innovations inclus deux dans la gamme décorative et dans le domaine technique et c'est notre intention de vous proposer l'offre la plus complète possible.

Pendant ces années, le management d' *MARVENT SYSTEM S.L.* a travaillé très dur pour vous offrir la meilleure valeur sur le marché, l'envoi de l'ordre dans le temps dont vous avez besoin et en accordant une attention à tous les détails. Le résultat est notre consolidation comme une entreprise leader dans le secteur grâce à notre large gamme de solutions décoratives et techniques, et le soin extrême dans notre service. Notre stock permanent nous permet de préparer les commandes rapidement. Nous offrons un service de personnalisation des commandes, et si demandé, nous personnalisons nos articles afin que vous «ne pas avoir à se soucier plus de l'installer une fois reçu. Notre logistique, puisque nous exportons dans plus de 65 pays, nous permet de faire nos expéditions rapidement et en temps.

Pour tout cela, nous tenons à vous remercier de votre confiance, parce que sans vous ce projet ne serait pas possible. Être votre fournisseur nous remplit de fierté, surtout dans ces temps difficiles où sont nécessaires à l'évolution de tous. Nous sommes à votre disposition. Tant notre personnel comme le management sont concentrés sur vous. Nous voulons que votre choix de faire confiance à *Marvent* être votre meilleure décision.

Il est vrai plaisir de compter sur votre confiance.

Condiciones Generales de Venta

GENERAL TERMS OF SALE / CONDITIONS DE VENTE

ENVÍO DE PEDIDOS.

Los pedidos se realizarán indicando nuestro número de referencia y enviándolo vía fax al +34 958 50 69 18 o vía e-mail:

administracion@marvent.es

PORTES E I.V.A.

Los pedidos serán enviados con los portes pagados si el importe mínimo supera los 100 euros. Para los pedidos inferiores, los portes serán cargados en factura. El I.V.A. correrá a cargo del cliente.

ANOMALÍA DEL ENVÍO.

Si la mercancía llega en mal estado debe notificarse en el albarán de entrega de la agencia. Si no se cumple este requisito no podremos hacernos cargo de las posibles incidencias. Dicha anomalía debe comunicarse **imprescindiblemente** en el **plazo NO superior a 24 horas**. Las devoluciones de mercancía deben ir acompañadas del albarán original.

PRECIOS.

Los precios y los productos publicados en este catálogo tiene reservado el derecho de ser modificados sin previo aviso por el fabricante.

SEGURO.

La mercancía viaja por cuenta y riesgo del comprador. Si el cliente desea asegurar la mercancía, correrá por parte del cliente la prima de seguro.

RESERVA DE DOMINIO.

Nuestras ventas se realizarán bajo reserva de dominio según el artículo 1506 de C.C. hasta que el valor de la mercancía se haya pagado íntegramente.

JURISDICCIÓN COMPETENTE.

El comprador acepta que toda desavenencia se realizará bajo la jurisdicción de los tribunales de Granada (España) renunciando expresamente a su propio fuero y domicilio.

ORDERS.

Orders should be sent with reference number of each article. The orders can be sent by fax +34 958 50 69 18 or by mail to:

administracion@marvent.es

PRICE.

Prices shown are ex-works Valencia. Due to the fluctuations of the international markets beyond our control, prices and terms of sale are subject to change without prior notice.

RETURN SHIPMENTS.

Returned goods will not be accepted without our prior authorization.

CLAIMS.

Goods must be checked upon arrival. Claims for faulty/wrong shipments and/or shortages must be made within **3 days** of receipt of goods. Claims for transport damages must be filled against the carrier immediately upon receipt.

RIGHTS RESERVED.

Our sales are always considered under the condition "Rights reserved" according to article 1506 C.C. until full payment has been settled.

VALID JURISDICTION.

In case of discrepancies, disagreements or litigation, the jurisdiction of the Granada (Spain) Courts of Law will prevail and will be accepted by the customer with waiver of his own jurisdiction of venue.

COMMANDES.

Les commandes doivent être envoyées avec le numéro de référence de chaque article. Veuillez nous envoyer vos commandes par fax +34 958 50 69 18 ou par e-mail:

administracion@marvent.es

PRIX.

Les prix indiqués dans le catalogue sont départ d'usine (exworks). A cause des fluctuations des marchés internationaux, les prix et les conditions de vente sont sujets à changement sans préavis.

RETOUR DE MARCHANDISE.

Les marchandises retournées ne seront pas acceptés sans notre autorisation préalable.

RÉCLAMATIONS.

Les marchandises doivent être vérifiées à l'arrivée. Les retours erreur d'envoi ou défaut de qualité doivent être faites dans les **3 jours** suivants à la réception de la marchandise. Les réclamations pour dommages de transport doivent être remplis sur le bon de livraison du transporteur dès réception.

CLAUSE DE RÉSERVE DE PROPRIÉTÉ.

Nos ventes sont toujours considérés comme la condition "Droits réservés" selon l'article 1506 CC jusqu'au paiement intégral a été réglée.

JURISDICTION COPMPÉTENTE.

IL'acheteur accepte qu'en cas de litige, Le tribunal compétent sois celui de Granada (Espagne).

MARVENT SYSTEM S.L.

Polg. Tecnológico Ogjares
C/ Valladolid, nave 39.3
18151 Ogjares (Granada)

Telf.: 958 50 38 20

Fax.: 958 50 69 18

E-mail: administracion@marvent.es

www.marvent.es

Pedidos: administracion@marvent.es

Curvatura de Rieles

RAILS BENDING INSTRUCTIONS / INSTRUCTIONS POUR CINTRAGE DES RAILS

CARACTERÍSTICAS GENERALES

MAIN FEATURES / CARACTÉRISTIQUES GÉNÉRALES

El Coste **incluye**: curvado, empaquetado y gastos adicionales de envío. Por su comodidad **consulte** siempre fechas de entrega y precios. El cliente debe proporcionar siempre una **plantilla** a tamaño real con el arco y radio de la curvatura. En el caso de que el cliente no la aporte, **Marvent** cobrará un importe de 30,60 € PVP (Ref. M.140). En los Rieles con más de una curva en Ángulo con el mismo grado, se cobrará 1 curvatura. Los Rieles con 2 o más Curvas en el mismo perfil, se servirán en 1 pieza siempre que sea posible. Si no fuera posible, el riel se servirá empleando empalmes para asegurar el deslizamiento correcto de las correderas.

The cost **includes**: Curving, packaging and additional shipping charges. For your convenience always **check** delivery dates and prices. The customer should always provide an actual size **template** with the arch and radius of curvature. In the case that the client does not supply it, **Marvent** will charge an amount of € 30.60 SRP (Ref. M.140). In Rails with more than one Angle curve with the same degree, one curvature will be charged. Rails with 2 or more curves in the same profile will be served in 1 piece whenever possible. If this is not possible, by using the rail joints we ensure the correct slip sliding.

Le coût **comprend**: la courbure, l'emballage et frais de livraison supplémentaires. Pour votre commodité toujours **vérifier** les dates de livraison et les prix. Le client doit toujours fournir un **modèle** de taille réelle avec un arc et rayon de courbure. Dans le cas où le client ne fournit pas, nous facturons un montant de € 30,60 RRP (Ref. M.140). Dans Rails avec plus d'une courbe en Angle avec les mêmes de degrés, une courbure sera facturée. Rails avec deux ou plusieurs courbes dans le même profil seront fournis dans une pièce chaque fois que possible. Si ce ne est pas possible, en utilisant les joints de rail nous assurons le glissement correct.

DISPONEMOS DE MÁQUINAS PROFESIONALES PARA CURVAR

Professional Curving Machine
Professionelle Machine de Courber



Arco /
Arch /
Arc



Ángulo /
Angle /
Courbure

REVA

Este Riel se curva empleando el Codo y/o el Rincón Original Reva, referenciado como:

I.205: Rincón esquina 90° - 17,07 € PVP

I.204: Codo esquina 90° - 17,07 € PVP

El radio mínimo es de 12 cm.

To bend the Riel, we use the outer/inner elbow with references:

I.205: exterior Corner 90 - € 17,07 RRP

I.204: interior Corner 90 - € 17,07 RRP

The minimum radius is 12 cm.

Pour plier le Riel, on utilise le coude extérieur ou intérieur avec références:

I.205: Coude ext 90 - € 17,07 RRP

I.204: Coude int 90 - € 17,07 RRP

Le rayon minimum est de 12 cm.

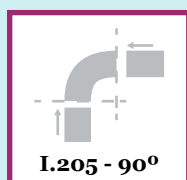

I.205 - 90°

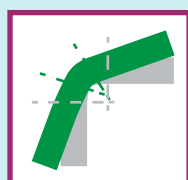
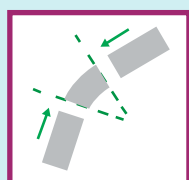

El cliente puede conseguir otro ángulo de curva si corta los extremos del I.204 o I.205. De este modo ya no existiría un ángulo de 90° sino el que se haya cortado. El cliente debe ajustar el corte y la curva en el momento de la instalación.

The customer can get another angled curving by cutting short ends I.205 or I.204. Thus it no longer exists 90° but the design that has been cut. This cut is made by the customer upon installation to adjust the curve with the wall where it will be installed.

Le client peut obtenir une autre courbe d'angle si courte les bouchons I.205 ou I.204. Ainsi ne existent plus de 90°, mais celui qu'on a coupé. Cette coupe est faite par le client lors de l'installation pour ajuster la courbe avec le mur où il sera installé.

RM09-TA / RM09-95

J.RC - precio por cada curvatura en Ángulo - 84,00 € PVP

J.RA - precio por cada curvatura en Arco - 126,00 € PVP

J.RC - price per each curvature in Angle - 84,00 € PVP

J.RA - price per each bend in Arch - 126,00 € RRP

J.RC - prix par angle de Courbure - 84,00 € PVP

J.RA - prix par coude Arc - 126,00 € RRP

Curvatura en Ángulo: radio mínimo 80 cm.

Curvature angle: minimum radius 80 cm.

Angle de courbure: rayon minimum 80 cm.

TRIM:

Curvar en Ángulo: 70 % del Precio Tarifa del Riel-Kit.
(Coste mínimo de 14,28 € PVP).

Curvar en Arco Continuo: 34,68 € PVP

Bending in Angle: 70% of the kit tariff price. (Minimum cost € 14.28 RRP).

Bending in Continuous Arch: € 34.68 RRP

Coût par courbe en Angle: 70% du prix tarif du kit.

(Coût minimum € 14,28 RRP).

Coût par cintrage en Arc continu: € 34,68 RRP.

El radio mínimo es de 10 cm.

The minimum radius is 10 cm. / Le rayon minimum est de 10 cm.

El riel se sirve en una pieza. No dispone de empalmes. Si hubiera 2 o más curvas en Arco, se servirá cada Arco por separado. Será función del cliente ajustarlo en el momento de la instalación.

The track is served in one piece. We haven't any joining piece for this purpose. If there were 2 or more curves in Arch, the arched piece of rail is served each separately. Customer will be in charge of adjust upon installation. /

Ce rail est fourni dans une pièce parce que nous n'avons pas disponibles les raccords. S'il y avait deux ou plusieurs courbes à Arc, les arcs sont fournis chaque séparément. Le client sera en charge d'ajuster lors de l'installation.

ARGENT

Curvar en Ángulo: 70 % del Precio de Tarifa del Riel-Kit.

(Coste mínimo de 14,28 € PVP).

Bending in Angle: 70% of the kit tariff price. (Minimum cost € 14.28 RRP). /

Coût par courbe en Angle: 70% du prix tarif du kit.

(Coût minimum € 14,28 RRP).

El radio mínimo es de 10 cm.

The minimum radius is 10 cm. / Le rayon minimum est de 10 cm.

MALEABLE

Puede curvarse en cualquier ángulo y forma. El cliente o el instalador puede curvarlo a mano porque no requiere máquina especial.







It can be bent at any angle and shape. The customer or the installer can bend it by hand because it does not require any special machine. /

Il peut être plié à ne importe quel angle et la forme. Le client ou l'installateur peuvent se plier à la main, car il ne nécessite pas de machine spéciale.

LÍNEA DECORATIVA Decorative Line / Ligne Decorative

1 . Rieles Decorativos / Decorative Tracks / Rails Décoratif	
1.1 • Riel Sintra.....	008
1.2 • Riel Obidos.....	014
1.3 • Riel Coimbra.....	015
1.4 • Riel Córcega.....	027
1.5 • Riel Capri.....	033
1.6 • Riel Inter.....	039
1.7 • Riel Led.....	043
1.8 • Riel Slim.....	047
2 . Barras Modernas / Modern Collection / Collection Moderne	
2.1 • Infinity 19/30	
2.1.1 • Infinity Zen.....	055
2.1.2 • Infinity Colors.....	057
2.1.3 • Infinity Vector.....	061
2.1.4 • Infinity Cristal.....	063
2.1.5 • Infinity Ice.....	065
2.1.6 • Infinity Polar.....	067
2.1.7 • Infinity Vanity.....	069
2.1.8 • Infinity Basic.....	071
2.1.9 • Infinity Exclusive.....	074
2.2 • Cavallier 19/30.....	089
2.3 • Varadero 19/30.....	099
3 . Barras Clásicas - Portavisillos / Classic Collection - Net curtain rods / Collections classiques - Petites Tringles	
3.1 • Duero 19/30.....	121
3.2 • Barra para Escalera 16.....	132
3.3 • Estrado y Museo.....	133
3.4 • Forja 19/30.....	135
3.5 • Belmonte 35.....	149
3.5 • Eclipse 19/30.....	161
3.6 • Portavisillos / Net Curtain Rods / Petites Tringles.....	172
3.6.1 • Extensible Frankfurt.....	173
3.6.2 • Extensible Café.....	173
3.6.3 • Extensible Berlín.....	173
3.6.4 • Extensible Bonn.....	174
3.6.5 • Extensible Praga.....	174
3.6.6 • Barras de Baño / Shower Curtain Rod / Rideau de Douche.....	175
4 . Galerías / Pelmet / Cantonnières.	
4.1 • Color System.....	179
4.2 • Madera / Wood / Bois.....	187
4.3 • Aluminio de 10 cm / Aluminium 10 cm.....	190
4.4 • Perfil para Bandó / Pelmet Rails / Rails pour Cantonnières.....	191
4.4.1 • Star.....	191
4.4.2 • Classic.....	191

LÍNEA BLANCA Aluminium Profiles / Rails en Aluminium

5 . Rieles Manuales / Hand-drawn curtain Tracks / Rails Manuelles	
5.1 • Trim.....	195
5.2 • Genil/Argent.....	200
5.3 • Riel 7300.....	202
5.4 • Basic.....	204
5.5 • Riel Fijo Hierro Serie 1000.....	205
5.6 • Nervión Doble T.....	210
5.7 • Riel Flexible.....	212
5.8 • Riel Flexible con velcro.....	213
5.9 • Múltiple.....	214
5.10 • Reva Manual.....	216
5.11 • RM09 Manual.....	219
6 . Rieles Cordón / Cord-drawn Curtain Tracks / Rails avec Corde	
6.1 • Reva Cordón.....	225
6.2 • Extensible de Hierro-Serie 1100...	228
6.3 • Extensible de Hierro-Serie M.....	230
7 . Rieles Motorizados / Motorized Curtain Tracks / Rails Motorisés	
7.1 • RM09 -TA, 43, 46, 92 y 95.....	233
8 . Estores / Roman Blinds / Stores Bateaux	
8.1 • Estor Oculto Marvent.....	243
8.2 • Startrack.....	247
8.3 • Motorizado / Motorized / Motorisé...	252
8.3 • Cadeneta.....	255
8.4 • Estor a cordón.....	260
8.5 • Troya.....	261
9 . Panel Japonés y Panel Japonés Motorizado / Sliding Panel & Motorized Sliding Panel / Parois Japonaise et Panel Japonaise Motorisée	
9.1 • Panel Japonés.....	269
9.1.1 • Panel 2 Vías.....	270
9.1.2 • Panel 3 Vías.....	271
9.1.3 • Panel 4 Vías.....	272
9.1.4 • Panel 5 Vías.....	273
9.2 • Panel Japonés Motorizado / Motorized Sliding Panel / Panel Japonaise Motorisée.....	281
10. Accesorios de Confección - Varios / Confection Accessories - Miscellaneous / Accessoires de Confection - Divers	
10.1 • Garfios / Hooks / Crochets.....	291
10.2 • Cintas / Tapes / Rubans.....	292
10.3 • Relleno de cojín y forro.....	300
10.4 • Ollaos / Eyelets / Oeillet.....	301
10.5 • Soporte Rápido / Quick Bracket / Support Express.....	310
10.6 • Contrapesos / Cordweight / Contrepoids.....	312

Índice / Index



Rieles Decorativos

Decorative Tracks
Rails Décoratif



Barras Modernas

Modern Collection
Collection Moderne



Barras Clásicas/ Portavisillos

Classic Collection /Net curtain rods
Collectiones clasiques / Petites Tringles



Galerías

Pelmets
Cantonnières



Rieles Manuales

Hand-drawn curtain Tracks
Rails Manuelles



Rieles Cordón

Cord-drawn Curtain Tracks
Rails avec Corde



Rieles motorizados

Motorized Curtain Tracks
Rails Motorisés



Estores

Roman Blinds
Stores Bateaux



Panel Japonés

Sliding Panel
Parois Japonaise



Accesorios de confección / Varios

Confection Accessories - Miscellaneous
Accessoires de Confection - Divers

Rieles decorativos

decorative tracks / rails décoratif

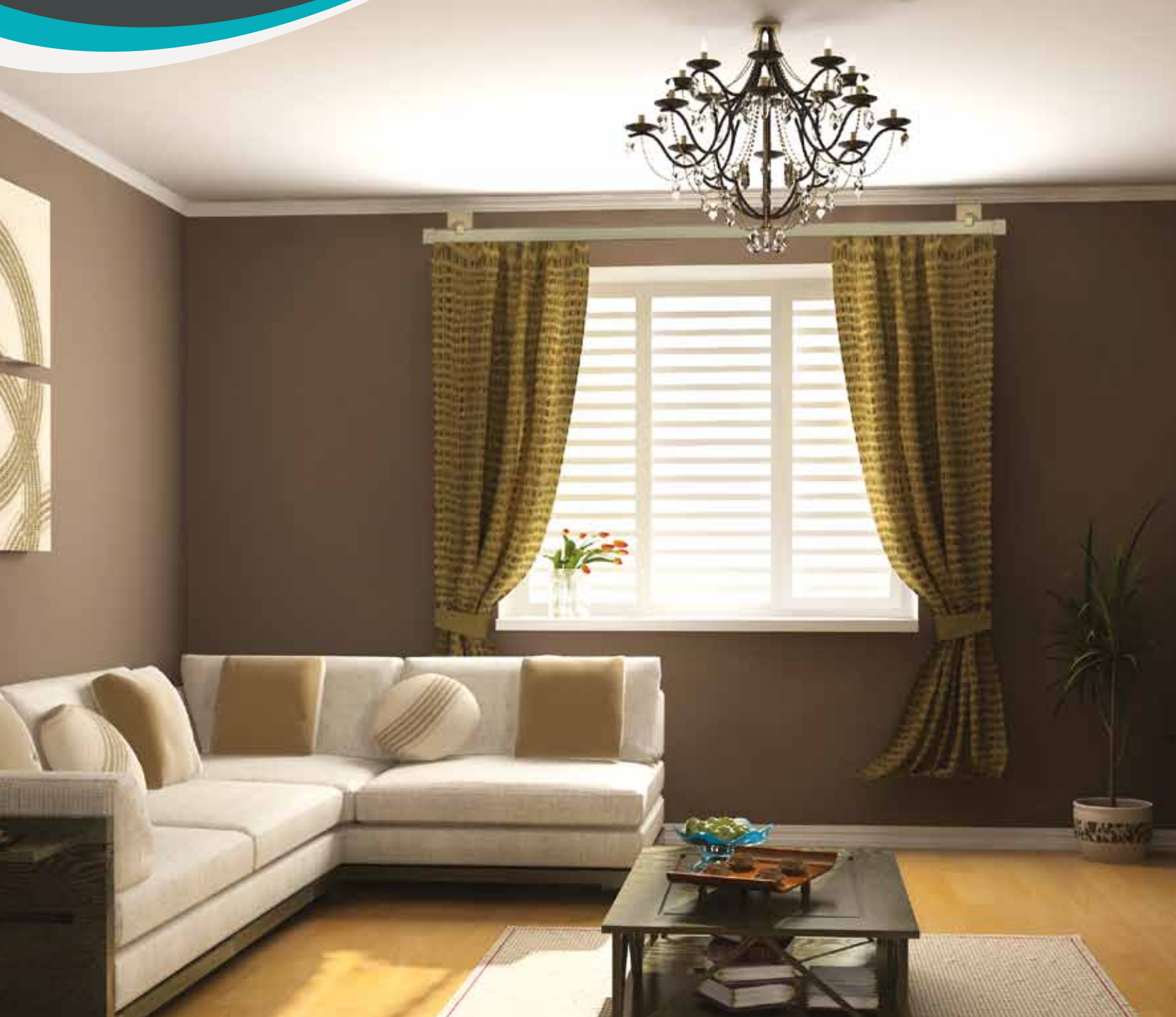
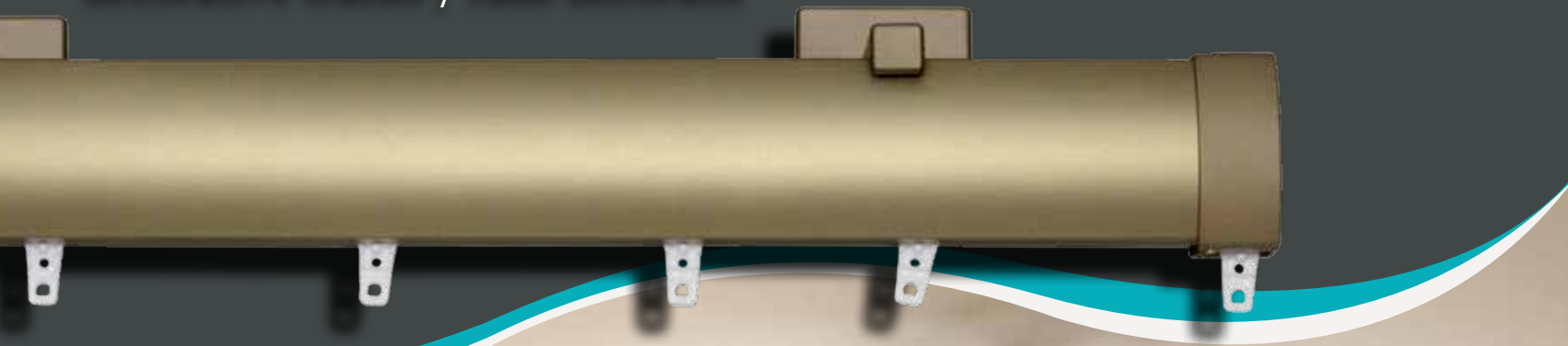

Marvent

SOLUCIONES PARA DECORAR VENTANAS

Opción Decorativa Sintra Manual Sintra Decorative Option Manual-drawn / Option Décoratif Tirage manuel



Bronze onda perfecta Ángulos
Bronze perfect wave /
Bronze onde parfait



Anodizado Plata onda perfecta Ángulos
Anodice nickel perfect wave /
Nickel anodisé onde parfait



Bronze correderas Olas
Bronze Wheeled gliders /
Bronze Glisseurs



Anodizado Plata correderas Trazos
Anodice nickel Wheeled gliders /
Nickel anodisé Glisseurs



Negro onda perfecta Ángulos
Black perfect wave /
Noir onde parfait



Blanco onda perfecta Ángulos
White perfect wave /
Blanc onde parfait



Negro cinta acordeón Olas
Black ruffle tape /
Noir Ruban acordeón



Blanco cinta acordeón Trazos
White ruffle tape /
Blanc Ruban acordeón

 Riel idealado para soportar peso y sufrir situaciones de uso severas y complicadas.

La forma cuadrangular del perfil del Riel Sintra y la calidad de su material, está diseñado expresamente para instalaciones donde se requiere un riel capaz de aguantar y deslizar (sin ningún problema), cortinas pesadas. Esta colección da solución a cualquier fórmula de montaje, tanto decorativas con soportes de acero o bronce, como funcionales con soportes de plástico para la instalación a techo de tipo riel, pudiendo desempeñar funciones de riel y de barra decorativa al mismo tiempo. Además incluye las **variantes de riel con cordón y sin cordón**.

Los terminales decorativos (novedad que hace del Riel Sintra uno de los más atractivos y deseados del mercado) tienen diseños idénticos pero asimétricos pensando en cada lado del riel. Usted podrá escoger los terminales para los conjuntos dobles, tanto para el riel interior como exterior.

 Aluminum rail with quadrangular shape, designed to hold heavy curtains and complicated installations.

The shape of the profile of the rail Sintra and the quality of its material, is designed specifically for installations where its needed a rail that holds and slides perfectly heavy curtains. This collection provides a solution to any installation so it can be used as a decorative rail and technical rail at the same time. SINTRA rail can be used an be used with special gliders for heavy curtains but also with ripple fold wave gliders to make the "perfect wave" (our economic system that ensures a perfect fall and a perfect wave on every curtain).

Available with cord-drawn and manual-drawn.

Its new decorative finials (that makes Sintra rail one of the most attractive of the market) have identical and asymmetrical designs for each side of the rail. You can choose the terminal for double sets also.

 La forme du profil du rail Sintra et la qualité de son matériel, est spécialement conçu pour les installations où il est nécessaire un rail qui détient et glisse parfaitement rideaux.

Cet rail offre une solution à toutes les installations, avec des supports décoratifs en couleur acier ou laiton et des supports fonctionnels comme son support en plastique pour le montage au plafond de sorte qu'il peut être utilisé comme un rail technique et décoratif en même temps. Le rail SINTRA peut être utilisé avec des glisseurs conçues pour les rideaux lourds, mais aussi avec les glisseurs pour ruban accordéon pour faire "l'onde parfaite" (notre système économique qui assure un tombé parfait et une onde parfaite à chaque rideau). **Disponible avec triage avec cordon ou tirage manuel.** Ses nouveaux embouts décoratifs (qui fait Sintra un des rails plus attractifs du marché) ont des conceptions identiques et aussi asymétriques pour chaque côté du rail. Vous pouvez choisir le terminal pour les rails doubles aussi.



Anodizado Plata onda perfecta Tapón Manual
Anodice nickel perfect wave /
Nickel anodicé onde parfait



Anodizado Plata onda perfecta Tapón Cordón
Anodice nickel perfect wave /
Nickel anodicé onde parfait



Bronce corredera Tapón Manual
Bronze perfect wave /
Bronze onde parfait

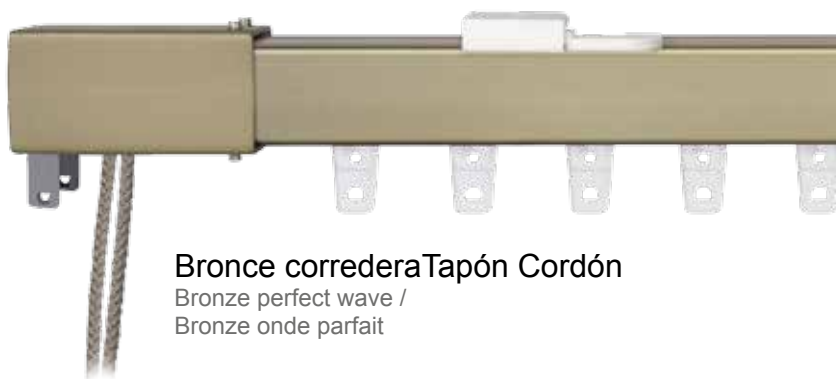

Bronce corredera Tapón Cordón
Bronze perfect wave /
Bronze onde parfait



Blanco onda perfecta Tapón Manual
White perfect wave /
Blanc onde parfait



Blanco onda perfecta Tapón Cordón
White perfect wave /
Blanc onde parfait



Negro cinta acordeón Tapón Manual
Black ruffle tape /
Noir Ruban acordeón



Negro cinta acordeón Tapón Cordón
Black ruffle tape /
Noir Ruban acordeón

Accionamiento Manual / Manual-Drawn / Tirage Manuel

Conjuntos simples con accionamiento manual y soporte a pared decorativo (23611-AF).
Manual-drawn single sets with wall Bracket (23611-AF).
Kits simples (tirage manuel) avec support mur (23611-AF).



Con Correderas / With Runners / Avec Glisseurs



REF	-AP	-BC	-BL	-NB					
23611-SMC100	-AP	-BC	-BL	-NB	2	10	1	51,98 €	100
23611-SMC150	-AP	-BC	-BL	-NB	2	16	1	60,24 €	150
23611-SMC200	-AP	-BC	-BL	-NB	2	20	1	67,86 €	200
23611-SMC250	-AP	-BC	-BL	-NB	3	26	1	89,12 €	250
23611-SMC300	-AP	-BC	-BL	-NB	3	30	1	96,74 €	300
23611-SMC350	-AP	-BC	-BL	-NB	3	36	1	104,98 €	350
23611-SMC400	-AP	-BC	-BL	-NB	3	40	1	112,60 €	400
23611-SMC450	-AP	-BC	-BL	-NB	3	46	1	120,86 €	450
23611-SMC500	-AP	-BC	-BL	-NB	4	50	1	141,47 €	500
23611-SMC600	-AP	-BC	-BL	-NB	4	60	1	157,31 €	600

Precio del conjunto completo incluyendo soporte decorativo a pared. /
Complete set price including wall decorative bracket. /
Prix kit complet compris support mur décoratif.

Con corredera Onda Perfecta / With Perfect Wave runner / Avec Onde Parfait glisseur



REF	-AP	-BC	-BL	-NB					
23611-SMP100	-AP	-BC	-BL	-NB	2	14	1	52,48 €	100
23611-SMP150	-AP	-BC	-BL	-NB	2	20	1	60,74 €	150
23611-SMP200	-AP	-BC	-BL	-NB	2	28	1	68,46 €	200
23611-SMP250	-AP	-BC	-BL	-NB	3	36	1	89,72 €	250
23611-SMP300	-AP	-BC	-BL	-NB	3	40	1	97,54 €	300
23611-SMP350	-AP	-BC	-BL	-NB	3	48	1	105,78 €	350
23611-SMP400	-AP	-BC	-BL	-NB	3	52	1	113,70 €	400
23611-SMP450	-AP	-BC	-BL	-NB	3	60	1	121,96 €	450
23611-SMP500	-AP	-BC	-BL	-NB	4	68	1	142,77 €	500
23611-SMP600	-AP	-BC	-BL	-NB	4	80	1	158,81 €	600

Precio del conjunto completo incluyendo soporte decorativo a pared. /
Complete set price including wall decorative bracket. /
Prix kit complet compris support mur décoratif.

Con Cinta Acordeón / With Ruffle Tape / Avec Ruban Accordéon



REF	-AP	-BC	-BL	-NB					
23611-SMA100	-AP	-BC	-BL	-NB	2	20	1	57,98 €	100
23611-SMA150	-AP	-BC	-BL	-NB	2	30	1	68,24 €	150
23611-SMA200	-AP	-BC	-BL	-NB	2	40	1	78,86 €	200
23611-SMA250	-AP	-BC	-BL	-NB	3	50	1	102,12 €	250
23611-SMA300	-AP	-BC	-BL	-NB	3	60	1	112,74 €	300
23611-SMA350	-AP	-BC	-BL	-NB	3	70	1	122,98 €	350
23611-SMA400	-AP	-BC	-BL	-NB	3	80	1	133,60 €	400
23611-SMA450	-AP	-BC	-BL	-NB	3	90	1	143,86 €	450
23611-SMA500	-AP	-BC	-BL	-NB	4	100	1	167,47 €	500
23611-SMA600	-AP	-BC	-BL	-NB	4	120	1	188,31 €	600

Precio del conjunto completo incluyendo soporte decorativo a pared. /
Complete set price including wall decorative bracket. /
Prix kit complet compris support mur décoratif.

NOTA: Para soporte de techo metálico, descontar del precio: 10,81 € por soporte (Ref. 23611-132 Z)

Precios de venta recomendados. IVA no incluido / S.R.P.: Suggested Retail Prices / Prix detail Conseillés

Accionamiento Manual /
Manual-Drawn / Tirage Manuel

Conjuntos dobles con accionamiento manual y soporte a pared decorativo (23611-AD).
Manual-drawn double sets with wall Bracket (23611-AD).
Kits doubles (tirage manuel) avec support mur (23611-AD).



Con Correderas / With Runners / Avec Glisseurs

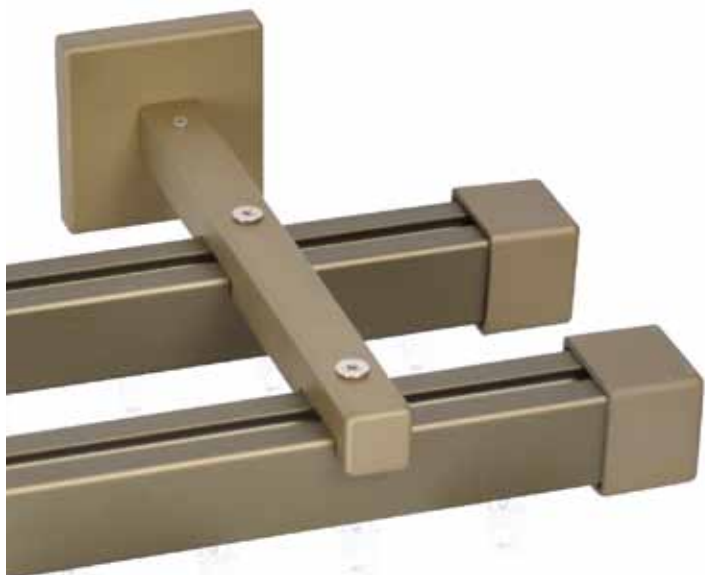

REF	-AP	-BC	-BL	-NB					
23611-SDMC100	-AP	-BC	-BL	-NB	2	20	1	84,23 €	100
23611-SDMC150	-AP	-BC	-BL	-NB	2	32	1	100,75 €	150
23611-SDMC200	-AP	-BC	-BL	-NB	2	40	1	115,99 €	200
23611-SDMC250	-AP	-BC	-BL	-NB	3	52	1	148,63 €	250
23611-SDMC300	-AP	-BC	-BL	-NB	3	60	1	163,88 €	300
23611-SDMC350	-AP	-BC	-BL	-NB	3	72	1	180,35 €	350
23611-SDMC400	-AP	-BC	-BL	-NB	3	80	1	195,60 €	400
23611-SDMC450	-AP	-BC	-BL	-NB	3	92	1	212,11 €	450
23611-SDMC500	-AP	-BC	-BL	-NB	4	100	1	243,48 €	500
23611-SDMC600	-AP	-BC	-BL	-NB	4	120	1	275,16 €	600

Precio del conjunto completo incluyendo soporte decorativo a pared. /
Complete set price including wall decorative bracket. /
Prix kit complet compris support mur décoratif.

Con corredera Onda Perfecta / With Perfect Wave runner / Avec Onde Parfait glisseur

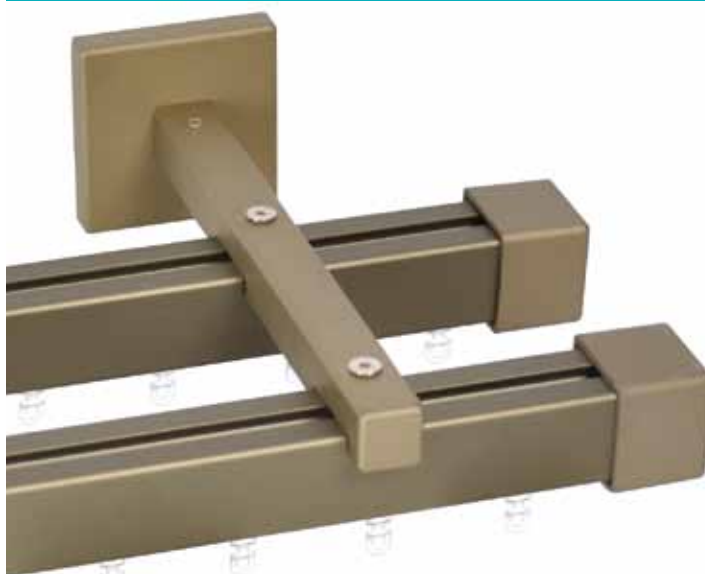

REF	-AP	-BC	-BL	-NB					
23611-SDMP100	-AP	-BC	-BL	-NB	2	28	1	85,23 €	100
23611-SDMP150	-AP	-BC	-BL	-NB	2	40	1	101,75 €	150
23611-SDMP200	-AP	-BC	-BL	-NB	2	56	1	117,19 €	200
23611-SDMP250	-AP	-BC	-BL	-NB	3	72	1	149,83 €	250
23611-SDMP300	-AP	-BC	-BL	-NB	3	80	1	165,48 €	300
23611-SDMP350	-AP	-BC	-BL	-NB	3	96	1	181,95 €	350
23611-SDMP400	-AP	-BC	-BL	-NB	3	104	1	197,80 €	400
23611-SDMP450	-AP	-BC	-BL	-NB	3	120	1	214,31 €	450
23611-SDMP500	-AP	-BC	-BL	-NB	4	136	1	246,08 €	500
23611-SDMP600	-AP	-BC	-BL	-NB	4	160	1	278,16 €	600

Precio del conjunto completo incluyendo soporte decorativo a pared. /
Complete set price including wall decorative bracket. /
Prix kit complet compris support mur décoratif.

Con Cinta Acordeón / With Ruffle Tape / Avec Ruban Accordéon

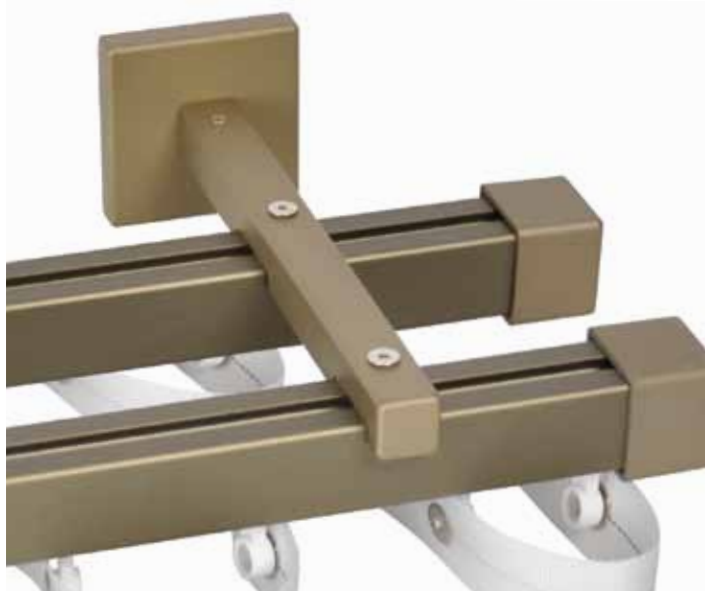

REF	-AP	-BC	-BL	-NB					
23611-SDMA100	-AP	-BC	-BL	-NB	2	40	1	96,23 €	100
23611-SDMA150	-AP	-BC	-BL	-NB	2	60	1	116,75 €	150
23611-SDMA200	-AP	-BC	-BL	-NB	2	80	1	137,99 €	200
23611-SDMA250	-AP	-BC	-BL	-NB	3	100	1	174,63 €	250
23611-SDMA300	-AP	-BC	-BL	-NB	3	120	1	195,88 €	300
23611-SDMA350	-AP	-BC	-BL	-NB	3	140	1	216,35 €	350
23611-SDMA400	-AP	-BC	-BL	-NB	3	160	1	237,60 €	400
23611-SDMA450	-AP	-BC	-BL	-NB	3	180	1	258,11 €	450
23611-SDMA500	-AP	-BC	-BL	-NB	4	200	1	295,48 €	500
23611-SDMA600	-AP	-BC	-BL	-NB	4	240	1	337,16 €	600

Precio del conjunto completo incluyendo soporte decorativo a pared. /
Complete set price including wall decorative bracket. /
Prix kit complet compris support mur décoratif.

Accionamiento a Cordón / Cord-Drawn / Tirage à Cordon



Conjuntos sencillos con accionamiento cordón y soporte a techo (23611-131A). Indicar en qué lado va el mando y la dirección de apertura.
Cord-drawn singles sets with Ceiling Bracket (23611-131A). Please indicate on which side the cord is required and the opening mode.
Kits simples (tirage avec corde) avec support plafond (23611-131A). Merci d'indiquer le côté de la corde et le sens d'ouverture.

Con Correderas / With Runners / Avec Glisseurs



REF	-AP	-BC	-BL	-NB					
23611-SCC100	-AP	-BC	-BL	-NB	2	10	1	48,36 €	100
23611-SCC150	-AP	-BC	-BL	-NB	3	16	1	57,58 €	150
23611-SCC200	-AP	-BC	-BL	-NB	4	20	1	66,28 €	200
23611-SCC250	-AP	-BC	-BL	-NB	4	26	1	75,50 €	250
23611-SCC300	-AP	-BC	-BL	-NB	5	30	1	85,00 €	300
23611-SCC350	-AP	-BC	-BL	-NB	5	36	1	94,24 €	350
23611-SCC400	-AP	-BC	-BL	-NB	6	40	1	102,94 €	400
23611-SCC450	-AP	-BC	-BL	-NB	6	46	1	112,18 €	450
23611-SCC500	-AP	-BC	-BL	-NB	7	50	1	121,68 €	500
23611-SCC600	-AP	-BC	-BL	-NB	8	60	1	139,62 €	600

Precio del conjunto completo con soporte a techo. /
Complete set price including ceiling brackets. / Prix kit complet compris support plafond.

Con corredera Onda Perfecta / With Perfect Wave runner / Avec Onde Parfait glisseur



(*) Cantidad de Correderas servidas con Apertura Central (otras opciones consultad).
Quantity of runners supplied with central opening (pls ask for further options). /
Nombre de glisseurs fournis avec ouverture central (demandez svp pour options additionelles).

REF	-AP	-BC	-BL	-NB					
23611-SCP100	-AP	-BC	-BL	-NB	2	14*	1	49,86 €	100
23611-SCP150	-AP	-BC	-BL	-NB	3	20*	1	59,08 €	150
23611-SCP200	-AP	-BC	-BL	-NB	4	28*	1	67,78 €	200
23611-SCP250	-AP	-BC	-BL	-NB	4	36*	1	77,00 €	250
23611-SCP300	-AP	-BC	-BL	-NB	5	40*	1	86,60 €	300
23611-SCP350	-AP	-BC	-BL	-NB	5	48*	1	95,84 €	350
23611-SCP400	-AP	-BC	-BL	-NB	6	52*	1	104,94 €	400
23611-SCP450	-AP	-BC	-BL	-NB	6	60*	1	114,18 €	450
23611-SCP500	-AP	-BC	-BL	-NB	7	68*	1	124,18 €	500
23611-SCP600	-AP	-BC	-BL	-NB	8	80*	1	142,62 €	600

Precio del conjunto completo con soporte a techo. /
Complete set price including ceiling brackets. / Prix kit complet compris support plafond.

Con Cinta Acordeón / With Ruffle Tape / Avec Ruban Accordéon



(*) Cantidad de Correderas servidas con Apertura Central (otras opciones consultad).
Quantity of runners supplied with central opening (pls ask for further options). /
Nombre de glisseurs fournis avec ouverture central (demandez svp pour options additionelles).

REF	-AP	-BC	-BL	-NB					
23611-SCA100	-AP	-BC	-BL	-NB	2	20*	1	50,86 €	100
23611-SCA150	-AP	-BC	-BL	-NB	3	30*	1	61,08 €	150
23611-SCA200	-AP	-BC	-BL	-NB	4	40*	1	71,28 €	200
23611-SCA250	-AP	-BC	-BL	-NB	4	50*	1	81,50 €	250
23611-SCA300	-AP	-BC	-BL	-NB	5	60*	1	92,00 €	300
23611-SCA350	-AP	-BC	-BL	-NB	5	70*	1	102,74 €	350
23611-SCA400	-AP	-BC	-BL	-NB	6	80*	1	112,94 €	400
23611-SCA450	-AP	-BC	-BL	-NB	6	90*	1	122,68 €	450
23611-SCA500	-AP	-BC	-BL	-NB	7	100*	1	133,68 €	500
23611-SCA600	-AP	-BC	-BL	-NB	8	120*	1	153,62 €	600

Precio del conjunto completo con soporte a techo. /
Complete set price including ceiling brackets. / Prix kit complet compris support plafond.

NOTA: Para soporte de techo metálico (Ref. 23611-132 Z), aumentar: 1,25 € por soporte

Precios de venta recomendados. IVA no incluido / S.R.P.: Suggested Retail Prices / Prix detail Conseillés

Accionamiento a Cordón /
Cord-Draw / Tirage à Cordon



Conjuntos dobles con accionamiento cordón y soporte a techo (23611-131A). Indicar en qué lado va el mando y la dirección de apertura.
Cord-drawn double sets with Ceiling Bracket (23611-131A). Please indicate on which side the cord is required and the opening mode.
Kits doubles (tirage avec corde) avec support plafond (23611-131A). Merci d'indiquer le côté de la corde et le sens d'ouverture.

Con Correderas / With Runners / Avec Glisseurs



REF	-AP	-BC	-BL	-NB					
23611-SDCC100	-AP	-BC	-BL	-NB	4	20	1	92,94 €	100
23611-SDCC150	-AP	-BC	-BL	-NB	6	32	1	110,96 €	150
23611-SDCC200	-AP	-BC	-BL	-NB	8	40	1	127,96 €	200
23611-SDCC250	-AP	-BC	-BL	-NB	8	52	1	145,96 €	250
23611-SDCC300	-AP	-BC	-BL	-NB	10	60	1	164,56 €	300
23611-SDCC350	-AP	-BC	-BL	-NB	10	72	1	182,58 €	350
23611-SDCC400	-AP	-BC	-BL	-NB	12	80	1	199,58 €	400
23611-SDCC450	-AP	-BC	-BL	-NB	12	92	1	217,58 €	450
23611-SDCC500	-AP	-BC	-BL	-NB	14	100	1	236,18 €	500
23611-SDCC600	-AP	-BC	-BL	-NB	16	120	1	271,20 €	600

Precio del conjunto completo con soporte a techo. /
Complete set price including ceiling brackets. / Prix kit complet compris support plafond.

Con corredera Onda Perfecta / With Perfect Wave runner / Avec Onde Parfait glisseur



REF	-AP	-BC	-BL	-NB					
23611-SDCP100	-AP	-BC	-BL	-NB	4	28*	1	94,94 €	100
23611-SDCP150	-AP	-BC	-BL	-NB	6	40*	1	113,96 €	150
23611-SDCP200	-AP	-BC	-BL	-NB	8	56*	1	131,96 €	200
23611-SDCP250	-AP	-BC	-BL	-NB	8	72*	1	150,96 €	250
23611-SDCP300	-AP	-BC	-BL	-NB	10	80*	1	170,56 €	300
23611-SDCP350	-AP	-BC	-BL	-NB	10	96*	1	189,58 €	350
23611-SDCP400	-AP	-BC	-BL	-NB	12	104*	1	207,58 €	400
23611-SDCP450	-AP	-BC	-BL	-NB	12	120*	1	226,58 €	450
23611-SDCP500	-AP	-BC	-BL	-NB	14	136*	1	246,18 €	500
23611-SDCP600	-AP	-BC	-BL	-NB	16	160*	1	283,20 €	600

Precio del conjunto completo con soporte a techo. /
Complete set price including ceiling brackets. / Prix kit complet compris support plafond.

Con Cinta Acordeón / With Ruffle Tape / Avec Ruban Accordéon



REF	-AP	-BC	-BL	-NB					
23611-SDCA100	-AP	-BC	-BL	-NB	4	40*	1	97,94 €	100
23611-SDCA150	-AP	-BC	-BL	-NB	6	60*	1	117,96 €	150
23611-SDCA200	-AP	-BC	-BL	-NB	8	80*	1	137,96 €	200
23611-SDCA250	-AP	-BC	-BL	-NB	8	100*	1	157,46 €	250
23611-SDCA300	-AP	-BC	-BL	-NB	10	120*	1	178,56 €	300
23611-SDCA350	-AP	-BC	-BL	-NB	10	140*	1	198,58 €	350
23611-SDCA400	-AP	-BC	-BL	-NB	12	160*	1	218,08 €	400
23611-SDCA450	-AP	-BC	-BL	-NB	12	180*	1	238,58 €	450
23611-SDCA500	-AP	-BC	-BL	-NB	14	200*	1	259,68 €	500
23611-SDCA600	-AP	-BC	-BL	-NB	16	240*	1	299,20 €	600

Precio del conjunto completo con soporte a techo. /
Complete set price including ceiling brackets. / Prix kit complet compris support plafond.

(*)
Cantidad de Correderas servidas con Apertura Central (otras opciones consultad).
Quantity of runners supplied with central opening (pls ask for further options). /
Nombre de glisseurs fournis avec ouverture central (demandez svp pour options additionnelles).

(*)
Cantidad de Correderas servidas con Apertura Central (otras opciones consultad).
Quantity of runners supplied with central opening (pls ask for further options). /
Nombre de glisseurs fournis avec ouverture central (demandez svp pour options additionnelles).



Anodizado Plata onda perfecta Tapón Manual
Anodice nickel perfect wave /
Nickel anodiché onde parfait

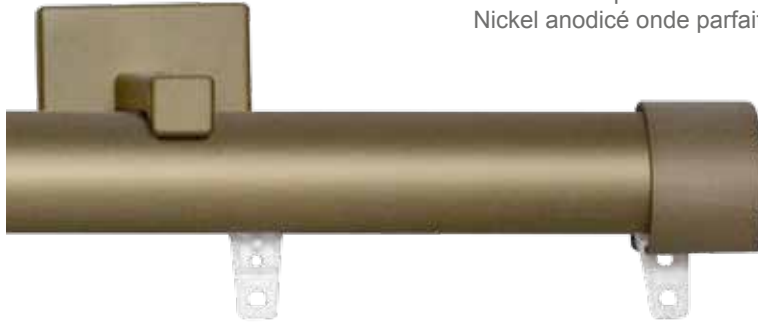

Bronze corredera Tapón Manual
Bronze perfect wave /
Bronze onde parfait



Blanco onda perfecta Tapón Manual
White perfect wave /
Blanc onde parfait



Negro cinta acordeón Tapón Manual
Black ruffle tape /
Noir Ruban acordeón



Anodizado Plata onda perfecta Tapón Cordón
Anodice nickel perfect wave /
Nickel anodiché onde parfait



Bronze corredera Tapón Cordón
Bronze perfect wave /
Bronze onde parfait



Blanco onda perfecta Tapón Cordón
White perfect wave /
Blanc onde parfait



Negro cinta acordeón Tapón Cordón
Black ruffle tape /
Noir Ruban acordeón



 El Riel **OBIDOS** está diseñado y patentado por Altran pensando en beneficiar a las empresas de decoración y de instalación de sistemas para decorar ventanas y a los profesionales del cortinaje. Los rieles decorativos Obidos, Coimbra y Sintra, tienen accesorios compatibles entre sí, por lo que en cada situación se podrá optar por una opción u otra sin tener que almacenar múltiples piezas de diferentes perfiles. El Riel Obidos está fabricado en aluminio y ha sido tratado para deslizar mejor y reducir el ruido. Soporta hasta **6 kg/m** y puede ser instalado a **Techo**, a **Pared** e incluso con soporte **Sencillo y Doble**. Dispone de la opción **Manual y a Cordón**. Permite la confección de cortinas con diferentes **sistemas, los tradicionales** pero también la **Onda Perfecta o la Onda Confort**. Además se puede realizar cualquier tipo de Apertura. Por último, **Marvent ofrece 2 años de garantía** en el aluminio y en los sistemas.

 The Obidos track is designed and patented by Altran aiming at making things easier to the companies and professionals dealing with the decoration of the window and curtains. In fact, our decorative tracks Obidos, Coimbra and Sintra have the same accessories, fully compatible with the 3 systems. This will permit to use a different system without the need of having their own exclusive accessories. The Obidos track is made of aluminium and it has been coated for a better sliding and less noisy performance. It can stand up to 6 kg/m and can be installed to wall or ceiling, even with a single or double bracket option. Supplied in manual or corded versions. Regarding the making of the curtain, it can be made with the traditional standard runner and also with the perfect and confort wave runner system. In addition, client can ask for any opening mode. **Marvent offers 2 years guarantee** in the aluminium systems.

 Le système Obidos est conçu et breveté par Altran visant à rendre les choses plus faciles aux entreprises et aux professionnels de la décoration de la fenêtre et les rideaux. En fait, nos rails décoratifs Obidos, Coimbra et Sintra ont les mêmes accessoires, entièrement compatibles avec les 3 systèmes. Cela permettra d'utiliser un autre système sans qu'il soit nécessaire d'avoir leurs propres accessoires exclusifs. Le rail Obidos est fait d'aluminium et il a été revêtu pour une meilleure performance de glissement, moins bruyant. Il peut supporter jusqu'à 6 kg / m et peut être installé au mur ou au plafond, même avec support simple ou double. Livré en version manuelle ou avec cordon. En ce qui concerne à la confection du rideau, il peut être fait avec des glisseurs standards traditionnelles et aussi avec le système d'onde parfaite et confort. Le client peut aussi demander tout mode d'ouverture. **Marvent offre 2 ans de garantie** dans les systèmes en aluminium.

Perfil con 2 Opciones: Ovalado y Plano.
Profile with 2 Options: Oval and Plain.
Profile avec 2 Options: Oval et Lisse.



Anodizado Plata onda perfecta Tapón Manual
Anodice nickel perfect wave /
Nickel anodiché onde parfait



Anodizado Plata onda perfecta Tapón Cordón
Anodice nickel perfect wave /
Nickel anodiché onde parfait



Bronze corredera Tapón Manual
Bronze perfect wave /
Bronze onde parfait



Bronze corredera Tapón Cordón
Bronze perfect wave /
Bronze onde parfait



Blanco onda perfecta Tapón Manual
White perfect wave /
Blanc onde parfait



Blanco onda perfecta Tapón Cordón
White perfect wave /
Blanc onde parfait



Negro cinta acordeón Tapón Manual
Black ruffle tape /
Noir Ruban acordeón



Negro cinta acordeón Tapón Cordón
Black ruffle tape /
Noir Ruban acordeón

Las características del Riel Obidos, Coimbra y Sintra presentan las mismas ventajas.

Sólo **se diferencian** en la forma del perfil de aluminio. Mientras que el Riel Sintra es cuadrado, el Riel Obidos es cilíndrico sin embargo la gran diferencia reside en que el Riel **Coimbra son 2 rieles en 1**. Por un lado es plano, pero si le damos la vuelta por el otro lado, su forma es curvada. Esto supone una opción más para ofertar por parte del decorador a sus clientes sin que esta ventaja suponga un aumento de precio.

Los tres rieles, Sintra, Obidos y Coimbra, permiten que la confección de las cortinas llegue hasta el extremo del riel pues dispone de tapas especiales para Cordón que permiten el uso completo del carril.

Sin duda estos rieles se han convertido en la colección de rieles decorativos más notable entre decoradores y confeccionistas debido a sus opciones de montaje, su facilidad de instalación, los múltiples accesorios y por su puesto por la compatibilidad entre ellos.

The Obidos, Coimbra and Sintra tracks have all the same advantages.

The only difference is the shape of each rail itself. Sintra is square, Obidos is cylindrical and regarding the third system, the Coimbra, we must emphasize its double use for the double shape it has, plain in one side and curved in the other, making this a price advantage when offering this system to the clients.

The three systems permit a total best use of the curtain since the side endcaps are supplied with a fixing system that allows the curtain reach both ends of the rail.

Surely, these systems have become the most preferred option for Decorators and Curtain-makers due to their several assembly options, easy installation, multiple accessories and its explained remarkable compatibility.

Les rails Obidos, Coimbra et Sintra ont tous les mêmes avantages.

La seule différence est la forme de chaque rail lui-même. Sintra est carré, Obidos est cylindrique et en ce qui concerne le troisième système, le Coimbra, il faut souligner sa double utilisation pour la double forme, d'un côté plat et courbé dans l'autre, ce qui en fait un avantage de prix lorsqu'ils offrent ce système à la clients.

Les trois systèmes permettent une meilleure utilisation totale du rideau parce que les embouts latéraux sont équipés d'un système de fixation qui permet au rideau atteindre les deux extrémités du rail.

Sûrement, ces systèmes sont devenus l'option la plus pratique pour Décorateurs et Confectionneurs de rideaux en raison de leurs différentes options de montage, installation facile, accessoires multiples et la déjà expliqué compatibilité remarquable.

OBIDOS

Accionamiento Manual / Manual-Drawn / Tirage Manuel



Conjuntos simples con accionamiento manual y soporte a pared decorativo (23611-AF).
Manual-drawn single sets with wall Bracket (23611-AF).
Kits simples (tirage manuel) avec support mur (23611-AF).

Con Correderas / With Runners / Avec Glisseurs

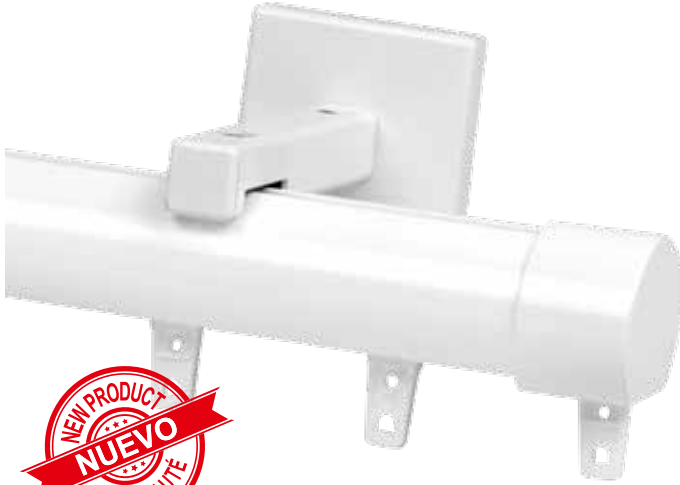

REF	-AP	-BC	-BL	-NB					
23615-OMC100	-AP	-BC	-BL	-NB	2	10	1	61,71 €	100
23615-OMC150	-AP	-BC	-BL	-NB	2	16	1	72,95 €	150
23615-OMC200	-AP	-BC	-BL	-NB	2	20	1	83,57 €	200
23615-OMC250	-AP	-BC	-BL	-NB	3	26	1	107,80 €	250
23615-OMC300	-AP	-BC	-BL	-NB	3	30	1	118,43 €	300
23615-OMC350	-AP	-BC	-BL	-NB	3	36	1	129,66 €	350
23615-OMC400	-AP	-BC	-BL	-NB	3	40	1	140,29 €	400
23615-OMC450	-AP	-BC	-BL	-NB	3	46	1	151,52 €	450
23615-OMC500	-AP	-BC	-BL	-NB	4	50	1	175,14 €	500
23615-OMC600	-AP	-BC	-BL	-NB	4	60	1	197,00 €	600

Precio del conjunto completo incluyendo soporte decorativo a pared. /
Complete set price including wall decorative bracket. /
Prix kit complet compris support mur décoratif.

Con corredera Onda Perfecta / With Perfect Wave runner / Avec Onde Parfait glisseur



REF	-AP	-BC	-BL	-NB					
23615-OMP100	-AP	-BC	-BL	-NB	2	14	1	62,21 €	100
23615-OMP150	-AP	-BC	-BL	-NB	2	20	1	73,45 €	150
23615-OMP200	-AP	-BC	-BL	-NB	2	28	1	84,17 €	200
23615-OMP250	-AP	-BC	-BL	-NB	3	36	1	108,40 €	250
23615-OMP300	-AP	-BC	-BL	-NB	3	40	1	119,23 €	300
23615-OMP350	-AP	-BC	-BL	-NB	3	48	1	130,46 €	350
23615-OMP400	-AP	-BC	-BL	-NB	3	52	1	141,39 €	400
23615-OMP450	-AP	-BC	-BL	-NB	3	60	1	152,62 €	450
23615-OMP500	-AP	-BC	-BL	-NB	4	68	1	176,44 €	500
23615-OMP600	-AP	-BC	-BL	-NB	4	80	1	198,50 €	600

Precio del conjunto completo incluyendo soporte decorativo a pared. /
Complete set price including wall decorative bracket. /
Prix kit complet compris support mur décoratif.

Con Cinta Acordeón / With Ruffle Tape / Avec Ruban Accordéon



REF	-AP	-BC	-BL	-NB					
23615-OMA100	-AP	-BC	-BL	-NB	2	20	1	67,71 €	100
23615-OMA150	-AP	-BC	-BL	-NB	2	30	1	80,95 €	150
23615-OMA200	-AP	-BC	-BL	-NB	2	40	1	94,57 €	200
23615-OMA250	-AP	-BC	-BL	-NB	3	50	1	120,80 €	250
23615-OMA300	-AP	-BC	-BL	-NB	3	60	1	134,43 €	300
23615-OMA350	-AP	-BC	-BL	-NB	3	70	1	147,66 €	350
23615-OMA400	-AP	-BC	-BL	-NB	3	80	1	161,29 €	400
23615-OMA450	-AP	-BC	-BL	-NB	3	90	1	174,52 €	450
23615-OMA500	-AP	-BC	-BL	-NB	4	100	1	201,14 €	500
23615-OMA600	-AP	-BC	-BL	-NB	4	120	1	228,00 €	600

Precio del conjunto completo incluyendo soporte decorativo a pared. /
Complete set price including wall decorative bracket. /
Prix kit complet compris support mur décoratif.

NOTA: Para soporte de techo metálico, descontar del precio: 10,81 € por soporte (Ref. 23611-132 Z)
Precios de venta recomendados. IVA no incluido / S.R.P.: Suggested Retail Prices / Prix detail Conseillés

Accionamiento A Cordón /
Cord-Draw / Tirage avec Cord



Conjuntos sencillos con accionamiento cordón y soporte a techo (23611-131A).
Cord-drawn singles sets with Ceiling Bracket (23611-131A).
Kits simples (tirage avec corde) avec support plafond (23611-131A).

Indicar en qué lado va el mando y la dirección de apertura.
Pls indicate on which side the cord is required and the opening mode.
Merci d'indiquer le côté de la corde et le sens d'ouverture.

Con Correderas / With Runners / Avec Glisseurs

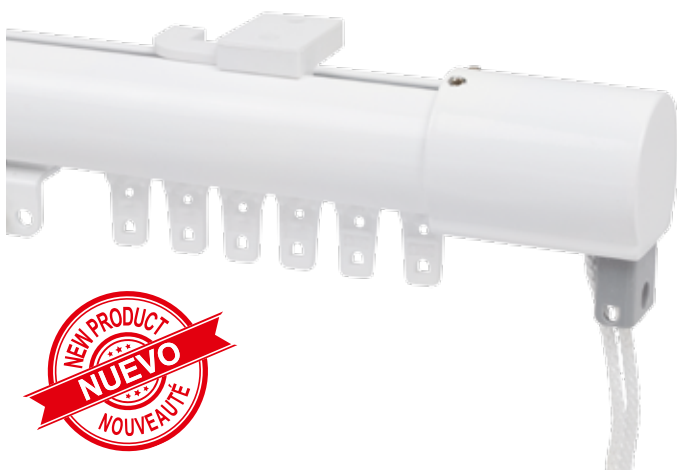

REF	-AP	-BC	-BL	-NB					cm
23615-OCC100	-AP	-BC	-BL	-NB	2	10	1	55,74 €	100
23615-OCC150	-AP	-BC	-BL	-NB	3	16	1	67,94 €	150
23615-OCC200	-AP	-BC	-BL	-NB	4	20	1	79,64 €	200
23615-OCC250	-AP	-BC	-BL	-NB	4	26	1	91,84 €	250
23615-OCC300	-AP	-BC	-BL	-NB	5	30	1	104,34 €	300
23615-OCC350	-AP	-BC	-BL	-NB	5	36	1	116,58 €	350
23615-OCC400	-AP	-BC	-BL	-NB	6	40	1	128,28 €	400
23615-OCC450	-AP	-BC	-BL	-NB	6	46	1	140,50 €	450
23615-OCC500	-AP	-BC	-BL	-NB	7	50	1	153,00 €	500
23615-OCC600	-AP	-BC	-BL	-NB	8	60	1	176,96 €	600

Precio del conjunto completo incluyendo soporte decorativo de techo. /
Complete set price including wall decorative bracket. /
Prix kit complet compris support mur décoratif.

Con corredera Onda Perfecta / With Perfect Wave runner / Avec Onde Parfait glisseur



REF	-AP	-BC	-BL	-NB					cm
23615-OCP100	-AP	-BC	-BL	-NB	2	14	1	57,24 €	100
23615-OCP150	-AP	-BC	-BL	-NB	3	20	1	69,44 €	150
23615-OCP200	-AP	-BC	-BL	-NB	4	28	1	81,14 €	200
23615-OCP250	-AP	-BC	-BL	-NB	4	36	1	93,34 €	250
23615-OCP300	-AP	-BC	-BL	-NB	5	40	1	105,94 €	300
23615-OCP350	-AP	-BC	-BL	-NB	5	48	1	118,18 €	350
23615-OCP400	-AP	-BC	-BL	-NB	6	52	1	130,28 €	400
23615-OCP450	-AP	-BC	-BL	-NB	6	60	1	142,50 €	450
23615-OCP500	-AP	-BC	-BL	-NB	7	68	1	155,50 €	500
23615-OCP600	-AP	-BC	-BL	-NB	8	80	1	179,96 €	600

Precio del conjunto completo incluyendo soporte decorativo de techo. /
Complete set price including wall decorative bracket. /
Prix kit complet compris support mur décoratif.

Con Cinta Acordeón / With Ruffle Tape / Avec Ruban Accordéon



REF	-AP	-BC	-BL	-NB					cm
23615-OCA100	-AP	-BC	-BL	-NB	2	20	1	58,24 €	100
23615-OCA150	-AP	-BC	-BL	-NB	3	30	1	71,44 €	150
23615-OCA200	-AP	-BC	-BL	-NB	4	40	1	84,64 €	200
23615-OCA250	-AP	-BC	-BL	-NB	4	50	1	97,84 €	250
23615-OCA300	-AP	-BC	-BL	-NB	5	60	1	111,34 €	300
23615-OCA350	-AP	-BC	-BL	-NB	5	70	1	125,08 €	350
23615-OCA400	-AP	-BC	-BL	-NB	6	80	1	138,28 €	400
23615-OCA450	-AP	-BC	-BL	-NB	6	90	1	151,00 €	450
23615-OCA500	-AP	-BC	-BL	-NB	7	100	1	165,00 €	500
23615-OCA600	-AP	-BC	-BL	-NB	8	120	1	190,96 €	600

Precio del conjunto completo incluyendo soporte decorativo de techo. /
Complete set price including wall decorative bracket. /
Prix kit complet compris support mur décoratif.

COIMBRA

Accionamiento Manual / Manual-Draw / Tirage Manuel



Conjuntos simples con accionamiento manual y soporte a pared decorativo (23611-AF).
Manual-drawn single sets with wall Bracket (23611-AF).
Kits simples (tirage manuel) avec support mur (23611-AF).

Con Correderas / With Runners / Avec Glisseurs



Perfil con 2 Opciones: Ovalado y Plano.
Se sirve por el lado ovalado. Si se quiere el lado plano hay que especificarlo en el pedido.
Profile with 2 Options: Oval and Plain.
Frontal oval side seen. Please specify if you want the plain side in front.
Profile avec 2 Options: Oval et Lisse.
Partie ovale vue. À spécifier si vous voulez vue la partie plate.

REF	-AP	-BC	-BL	-NB					
23616-CMC100	-AP	-BC	-BL	-NB	2	10	1	69,98 €	100
23616-CMC150	-AP	-BC	-BL	-NB	2	16	1	84,32 €	150
23616-CMC200	-AP	-BC	-BL	-NB	2	20	1	98,04 €	200
23616-CMC250	-AP	-BC	-BL	-NB	3	26	1	125,37 €	250
23616-CMC300	-AP	-BC	-BL	-NB	3	30	1	139,10 €	300
23616-CMC350	-AP	-BC	-BL	-NB	3	36	1	153,43 €	350
23616-CMC400	-AP	-BC	-BL	-NB	3	40	1	167,16 €	400
23616-CMC450	-AP	-BC	-BL	-NB	3	46	1	181,49 €	450
23616-CMC500	-AP	-BC	-BL	-NB	4	50	1	208,21 €	500
23616-CMC600	-AP	-BC	-BL	-NB	4	60	1	236,27 €	600

Precio del conjunto completo con soporte de pared. / Complete set price including ceiling brackets. / Prix kit complet compris support plafond.

Con corredera Onda Perfecta / With Perfect Wave runner / Avec Onde Parfait glisseur



Perfil con 2 Opciones: Ovalado y Plano.
Se sirve por el lado ovalado. Si se quiere el lado plano hay que especificarlo en el pedido.
Profile with 2 Options: Oval and Plain.
Frontal oval side seen. Please specify if you want the plain side in front.
Profile avec 2 Options: Oval et Lisse.
Partie ovale vue. À spécifier si vous voulez vue la partie plate.

REF	-AP	-BC	-BL	-NB					
23616-CMP100	-AP	-BC	-BL	-NB	2	14	1	70,48 €	100
23616-CMP150	-AP	-BC	-BL	-NB	2	20	1	84,82 €	150
23616-CMP200	-AP	-BC	-BL	-NB	2	28	1	98,64 €	200
23616-CMP250	-AP	-BC	-BL	-NB	3	36	1	125,97 €	250
23616-CMP300	-AP	-BC	-BL	-NB	3	40	1	139,90 €	300
23616-CMP350	-AP	-BC	-BL	-NB	3	48	1	154,23 €	350
23616-CMP400	-AP	-BC	-BL	-NB	3	52	1	168,26 €	400
23616-CMP450	-AP	-BC	-BL	-NB	3	60	1	182,59 €	450
23616-CMP500	-AP	-BC	-BL	-NB	4	68	1	209,51 €	500
23616-CMP600	-AP	-BC	-BL	-NB	4	80	1	237,77 €	600

Precio del conjunto completo con soporte de pared. / Complete set price including ceiling brackets. / Prix kit complet compris support plafond.

Con Cinta Acordeón / With Ruffle Tape / Avec Ruban Accordéon



Perfil con 2 Opciones: Ovalado y Plano.
Se sirve por el lado ovalado. Si se quiere el lado plano hay que especificarlo en el pedido.
Profile with 2 Options: Oval and Plain.
Frontal oval side seen. Please specify if you want the plain side in front.
Profile avec 2 Options: Oval et Lisse.
Partie ovale vue. À spécifier si vous voulez vue la partie plate.

REF	-AP	-BC	-BL	-NB					
23616-CMA100	-AP	-BC	-BL	-NB	2	20	1	75,98 €	100
23616-CMA150	-AP	-BC	-BL	-NB	2	30	1	92,32 €	150
23616-CMA200	-AP	-BC	-BL	-NB	2	40	1	109,04 €	200
23616-CMA250	-AP	-BC	-BL	-NB	3	50	1	138,37 €	250
23616-CMA300	-AP	-BC	-BL	-NB	3	60	1	155,10 €	300
23616-CMA350	-AP	-BC	-BL	-NB	3	70	1	171,43 €	350
23616-CMA400	-AP	-BC	-BL	-NB	3	80	1	188,16 €	400
23616-CMA450	-AP	-BC	-BL	-NB	3	90	1	204,49 €	450
23616-CMA500	-AP	-BC	-BL	-NB	4	100	1	234,21 €	500
23616-CMA600	-AP	-BC	-BL	-NB	4	120	1	267,27 €	600

Precio del conjunto completo con soporte de pared. / Complete set price including ceiling brackets. / Prix kit complet compris support plafond.

NOTA: Para soporte de techo metálico, descontar del precio: 10,81 € por soporte (Ref. 23611-132 Z)

Precios de venta recomendados. IVA no incluido / S.R.P.: Suggested Retail Prices / Prix detail Conseillés

Accionamiento A Cordón /
Cord-Drawn / Tirage avec Cord



Conjuntos sencillos con accionamiento cordón y soporte a techo (23611-131A).
Cord-drawn singles sets with Ceiling Bracket (23611-131A).
Kits simples (tirage avec corde) avec support plafond (23611-131A).

Indicar en qué lado va el mando y la dirección de apertura.
Pls indicate on which side the cord is required and the opening mode.
Merci d'indiquer le côté de la corde et le sens d'ouverture.

Con Correderas / With Runners / Avec Glisseurs



Perfil con 2 Opciones: Ovalado y Plano.
Se sirve por el lado ovalado. Si se quiere el lado plano hay que especificarlo en el pedido.
Profile with 2 Options: Oval and Plain.
Frontal oval side seen. Please specify if you want the plain side in front.
Profile avec 2 Options: Oval et Lisse.
Partie ovale vue. À spécifier si vous voulez vue la partie plate.

REF	-AP	-BC	-BL	-NB					
23616-CCC100	-AP	-BC	-BL	-NB	2	10	1	64,02 €	100
23616-CCC150	-AP	-BC	-BL	-NB	3	16	1	79,32 €	150
23616-CCC200	-AP	-BC	-BL	-NB	4	20	1	94,12 €	200
23616-CCC250	-AP	-BC	-BL	-NB	4	26	1	109,42 €	250
23616-CCC300	-AP	-BC	-BL	-NB	5	30	1	125,02 €	300
23616-CCC350	-AP	-BC	-BL	-NB	5	36	1	140,36 €	350
23616-CCC400	-AP	-BC	-BL	-NB	6	40	1	155,16 €	400
23616-CCC450	-AP	-BC	-BL	-NB	6	46	1	170,48 €	450
23616-CCC500	-AP	-BC	-BL	-NB	7	50	1	186,08 €	500
23616-CCC600	-AP	-BC	-BL	-NB	8	60	1	216,24 €	600

Precio del conjunto completo con soporte de techo. /
Complete set price including ceiling brackets. / Prix kit complet compris support plafond.

Con corredera Onda Perfecta / With Perfect Wave runner / Avec Onde Parfait glisseur



Perfil con 2 Opciones: Ovalado y Plano.
Se sirve por el lado ovalado. Si se quiere el lado plano hay que especificarlo en el pedido.
Profile with 2 Options: Oval and Plain.
Frontal oval side seen. Please specify if you want the plain side in front.
Profile avec 2 Options: Oval et Lisse.
Partie ovale vue. À spécifier si vous voulez vue la partie plate.

REF	-AP	-BC	-BL	-NB					
23616-CCP100	-AP	-BC	-BL	-NB	2	14	1	65,52 €	100
23616-CCP150	-AP	-BC	-BL	-NB	3	20	1	80,82 €	150
23616-CCP200	-AP	-BC	-BL	-NB	4	28	1	95,62 €	200
23616-CCP250	-AP	-BC	-BL	-NB	4	36	1	110,92 €	250
23616-CCP300	-AP	-BC	-BL	-NB	5	40	1	126,62 €	300
23616-CCP350	-AP	-BC	-BL	-NB	5	48	1	141,96 €	350
23616-CCP400	-AP	-BC	-BL	-NB	6	52	1	157,16 €	400
23616-CCP450	-AP	-BC	-BL	-NB	6	60	1	172,48 €	450
23616-CCP500	-AP	-BC	-BL	-NB	7	68	1	188,58 €	500
23616-CCP600	-AP	-BC	-BL	-NB	8	80	1	219,24 €	600

Precio del conjunto completo con soporte de techo. /
Complete set price including ceiling brackets. / Prix kit complet compris support plafond.

Con Cinta Acordeón / With Ruffle Tape / Avec Ruban Accordéon



Perfil con 2 Opciones: Ovalado y Plano.
Se sirve por el lado ovalado. Si se quiere el lado plano hay que especificarlo en el pedido.
Profile with 2 Options: Oval and Plain.
Frontal oval side seen. Please specify if you want the plain side in front.
Profile avec 2 Options: Oval et Lisse.
Partie ovale vue. À spécifier si vous voulez vue la partie plate.

REF	-AP	-BC	-BL	-NB					
23616-CCA100	-AP	-BC	-BL	-NB	2	20	1	66,52 €	100
23616-CCA150	-AP	-BC	-BL	-NB	3	30	1	82,82 €	150
23616-CCA200	-AP	-BC	-BL	-NB	4	40	1	99,12 €	200
23616-CCA250	-AP	-BC	-BL	-NB	4	50	1	115,42 €	250
23616-CCA300	-AP	-BC	-BL	-NB	5	60	1	132,02 €	300
23616-CCA350	-AP	-BC	-BL	-NB	5	70	1	148,86 €	350
23616-CCA400	-AP	-BC	-BL	-NB	6	80	1	165,16 €	400
23616-CCA450	-AP	-BC	-BL	-NB	6	90	1	180,98 €	450
23616-CCA500	-AP	-BC	-BL	-NB	7	100	1	198,08 €	500
23616-CCA600	-AP	-BC	-BL	-NB	8	120	1	230,24 €	600

Precio del conjunto completo con soporte de techo. /
Complete set price including ceiling brackets. / Prix kit complet compris support plafond.

Trazos
Sintra Fial /
Embout Sintra

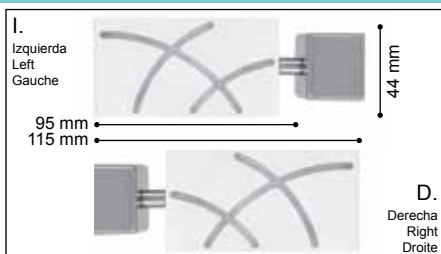

REF	∅				
23611-P.21ABLD		10	21,00 €	24,15 €	
23611-P.21ABLI		10	21,00 €	24,15 €	

* Terminal para Riel Manual Sintra /
Finales for hand-drawn Sintra System / Embouts pour Système Sintra Manual

Ángulos blanco
Sintra Fial /
Embout Sintra

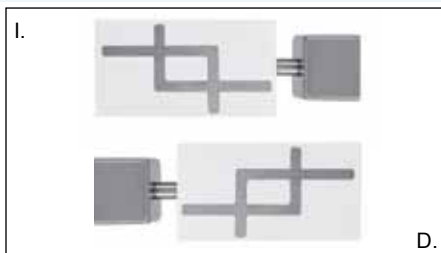

REF	∅				
23611-P.22ABLD		10	21,00 €	24,15 €	
23611-P.22ABLI		10	21,00 €	24,15 €	

* Terminal para Riel Manual Sintra /
Finales for hand-drawn Sintra System / Embouts pour Système Sintra Manual

Ángulos negro
Sintra Fial /
Embout Sintra

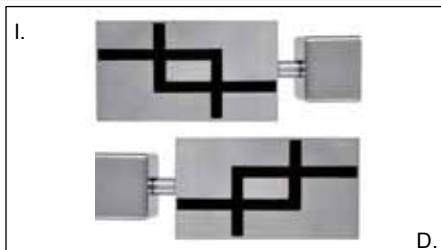

REF	∅				
23611-P.23ABLD		10	21,24 €	24,43 €	
23611-P.23ABLI		10	21,24 €	24,43 €	

* Terminal para Riel Manual Sintra /
Finales for hand-drawn Sintra System / Embouts pour Système Sintra Manual

Olas
Sintra Fial /
Embout Sintra



REF	∅				
23611-P.24ABLD		10	21,92 €	25,21 €	
23611-P.24ABLI		10	21,92 €	25,21 €	

* Terminal para Riel Manual Sintra /
Finales for hand-drawn Sintra System / Embouts pour Système Sintra Manual

Trazos
Sintra Fial /
Embout Sintra

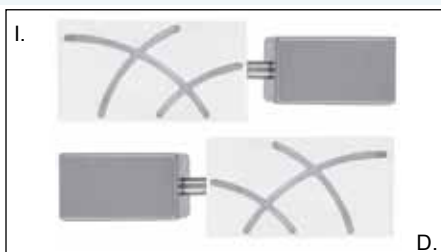

REF	∅				
23611-P.25ABLD		10	22,06 €	25,37 €	
23611-P.25ABLI		10	22,06 €	25,37 €	

* Terminal para Riel A Cordón Sintra /
Finales for cord-drawn Sintra System / Embouts pour système tirage Sintra à cordon

Ángulos blanco
Sintra Fial /
Embout Sintra

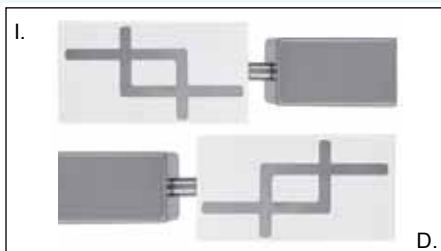

REF	∅				
23611-P.26ABLD		10	22,06 €	25,37 €	
23611-P.26ABLI		10	22,06 €	25,37 €	

* Terminal para Riel A Cordón Sintra /
Finales for cord-drawn Sintra System / Embouts pour système tirage Sintra à cordon

Ángulos negro
Sintra Fial /
Embout Sintra

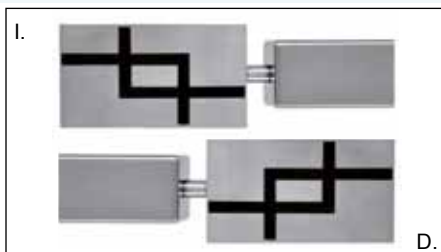

REF	∅				
23611-P.27ABLD		10	22,06 €	25,37 €	
23611-P.27ABLI		10	22,06 €	25,37 €	

* Terminal para Riel A Cordón Sintra /
Finales for cord-drawn Sintra System / Embouts pour système tirage Sintra à cordon

Olas
Sintra Fial /
Embout Sintra

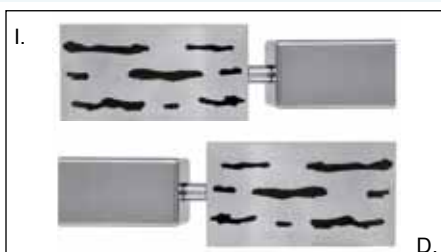

REF	∅				
23611-P.28ABLD		10	22,92 €	26,36 €	
23611-P.28ABLI		10	22,92 €	26,36 €	

* Terminal para Riel A Cordón Sintra /
Finales for cord-drawn Sintra System / Embouts pour système tirage Sintra à cordon



Perfil Sintra
(Cordón y Manual)
Max. 6 kg./m.

Sintra Track (Corded &
Manual Sistem) /
Rail Sintra
(Tirage avec Corde et
Manuel)



REF	-AP	-BC	-BL	-NB	U	€	€	cm
23611-120342	-AP	-BC	-BL	-NB	60 m	11,13 €	12,80 €	600

Perfiles Obidos
(Cordón y Manual) /

Obidos Track
(Corded & Manual
Sistem) /
Rail Obidos
(Tirage avec Corde
et Manuel)



REF	-AP	-BC	-BL	-NB	U	€	€	cm
23615-120442	-AP	-BC	-BL	-NB	60 m	16,36 €	18,82 €	600



Perfiles Coimbra
(Cordón y Manual)

Coimbra Track
(Corded & Manual
Sistem) /
Rail Coimbra
(Tirage avec Corde
et Manuel)

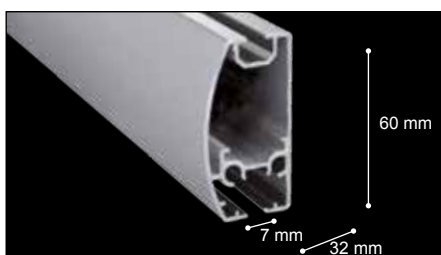

REF	-AP	-BC	-BL	-NB	U	€	€	cm
23616-120542	-AP	-BC	-BL	-NB	60 m	21,74 €	25,00 €	600



Terminal Tapón
Sintra
(Sistema Cordón)

Sintra finial
(Corded System) /
Embout Sintra
(Tirage avec Corde)

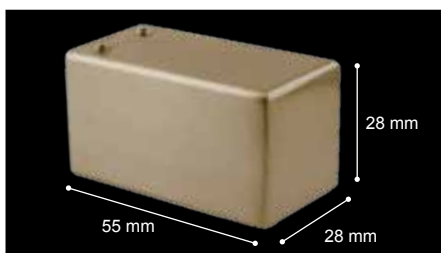

REF	∅	U	€	€	cm
23611-55A		10	6,40 €	7,36 €	
23611-55BR		10	6,40 €	7,36 €	
23611-55B		10	6,40 €	7,36 €	
23611-55N		10	6,40 €	7,36 €	

Terminal Tapón
Sintra
(Sistema Manual)

Sintra Finial
(Manual System) /
Embout Sintra
(Tirage Manuel)

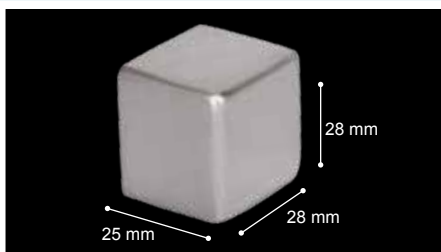

REF	∅	U	€	€	cm
23611-ATE		10	4,18 €	4,81 €	
23611-BRTE		10	4,18 €	4,81 €	
23611-BTE		10	4,18 €	4,81 €	
23611-NTE		10	4,18 €	4,81 €	



SINTRA, OBIDOS Y COIMBRA

Accesorios / Accessories / Accessoires

A AP
 BR BC
 B BL
 N NB

Terminal Tapón Obidos (Sistema Manual) Obidos Final (Manual System) / Embout Obidos (Tirage Manuel)	<p>35 mm 25 mm 40 mm</p>	REF	∅					NEW
		23615-56A		10	5,80 €	6,67 €		
		23615-56BC		10	5,80 €	6,67 €		
		23615-56BL		10	5,80 €	6,67 €		
		23615-56NB		10	5,80 €	6,67 €		
Terminal Tapón Obidos (Sistema Cordón) Obidos final (Corded System) / Embout Obidos (Tirage avec Corde)	<p>38 mm 54 mm 40 mm</p>	REF	∅					NEW
		23615-58A		10	7,00 €	8,05 €		
		23615-58BC		10	7,00 €	8,05 €		
		23615-58BL		10	7,00 €	8,05 €		
		23615-58NB		10	7,00 €	8,05 €		
Terminal Tapón Coimbra (lado D e I) (Sistema Manual) Coimbra Final (side D & I) (Manual System) / Embout Coimbra (côté D et I) (Tirage Manuel)	<p>D: derecha right droit I: izquierda left gauche 65 mm 25 mm 37 mm</p>	REF	∅					NEW
		23615-57AD/AI		10	6,70 €	7,71 €		
		23615-57BCD/BCI		10	6,70 €	7,71 €		
		23615-57BLD/BLI		10	6,70 €	7,71 €		
		23615-57NLD/NLI		10	6,70 €	7,71 €		
Terminal Tapón Coimbra (Sistema Cordón) Coimbra Final (side D & I) (Corded System) / Embout Coimbra (côté D et I) (Tirage avec Corde)	<p>D: derecha right droit I: izquierda left gauche 68 mm 54 mm 37 mm</p>	REF	∅					NEW
		23615-59AD/AI		10	7,90 €	9,09 €		
		23615-59BC		10	7,90 €	9,09 €		
		23615-59BL		10	7,90 €	9,09 €		
		23615-59NB		10	7,90 €	9,09 €		
Soporte Pared Wall Brackets / Supports Mur	<p>91 mm 52 mm 13 mm 25,5 mm</p>	REF	∅					
		23611-AF		10	11,30 €	13,00 €		
		23611-BRF		10	11,30 €	13,00 €		
		23611-BF		10	11,30 €	13,00 €		
		23611-NF		10	11,30 €	13,00 €		
* Soporte incluido en el Kit Sencillo Manual / Bracket supplied in the Manual Single Kit / Support fourni dans le Manuel Simple Kit.								
Soporte Doble Pared Double Wall Bracket / Support Mur Double	<p>171 mm</p>	REF	∅					
		23611-AD		10	14,02 €	16,12 €		
		23611-BRD		10	14,02 €	16,12 €		
		23611-BD		10	14,02 €	16,12 €		
		23611-ND		10	14,02 €	16,12 €		
* Soporte incluido en el Kit Doble Manual / Bracket supplied in the Manual Double kit / Support fourni dans le Manuel Kit Double.								
Soporte Pared Largo Long Wall Bracket / Support Mur Long	<p>171 mm</p>	REF	∅					
		23611-AFL		10	14,02 €	16,12 €		
		23611-BRFL		10	14,02 €	16,12 €		
		23611-BFL		10	14,02 €	16,12 €		
		23611-NFL		10	14,02 €	16,12 €		
Soporte Techo Ceiling Bracket / Support Plafond	<p>45 mm</p>	REF	∅					
		23611-AT		10	11,64 €	13,39 €		
		23611-BRT		10	11,64 €	13,39 €		
		23611-BT		10	11,64 €	13,39 €		
		23611-NT		10	11,64 €	13,39 €		

Soporte Techo
Plástico

Plastic Ceiling
Bracket /
Support Plafond
Plastique



REF	∅	U	€	€	cm
23611-131A		100	0,82 €	0,94 €	

* Soporte incluido en el Kit Sencillo y Doble a Cordón. /
Bracket supplied in the Single & Double Kit with Cord /
Support fourni dans le Simple et Double Kit avec Cord.

Soporte Techo
Metálico Especial

Metallic specialized
ceiling bracket /
Support plafond
spécialisé
(en métal)

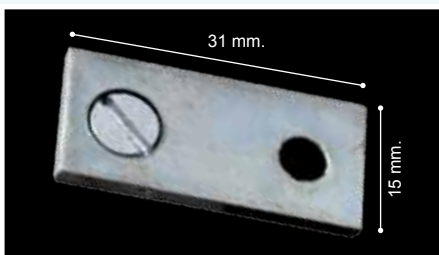

REF	∅	U	€	€	cm
23611-132Z		25	1,90 €	2,19 €	



Cantonera de
Plástico

Plastic end Pulley /
Angles Plástico



REF	∅	U	€	€	cm
23611-63		25	2,98 €	3,43 €	

Corredera Maestra
Sintra Cinta

Acordeón Derecha
Sintra master carrier
ruffle tape (right) /
Porteur principal
sintra ruban
accordeon (droite)



REF	∅	U	€	€	cm
23611-1026		25	5,88 €	6,76 €	

Corredera Maestra
Sintra Cinta

Acordeón Izquierda
Sintra master carrier
ruffle tape (left) /
Porteur principal
sintra ruban
accordeon (gauche)



REF	∅	U	€	€	cm
23611-1027		25	5,88 €	6,76 €	

Corredera Maestra
con Brazo Sintra

Sintra master carrier
with arm /
Porteur principal
sintra avec bras



REF	∅	U	€	€	cm
23611-1028		25	3,80 €	4,31 €	

Corredera Maestra
sin Brazo Sintra

Sintra master carrier
without arm /
Porteur principal
sintra sans bras

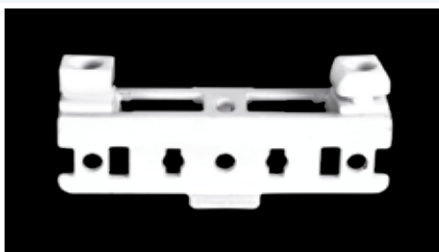

REF	∅	U	€	€	cm
23611-1029		25	2,70 €	3,11 €	

Empalme Sintra
(Manual y Cordón)

Sintra splice
(corded & manual
system) /
Raccordeur Sintra
(tirage avec corde
et manuel)



REF	∅	U	€	€	cm
23611-05PL		10	6,86 €	7,89 €	

Accesorios / Accesories / Accessoires

Rollo Corredera Onda Perfecta Perfect wave runners roll / Rouleau de glisseur "onde parfaite"		<table border="1"> <thead> <tr> <th>REF</th> <th>∅</th> <th></th> <th></th> <th></th> <th></th> </tr> </thead> <tbody> <tr> <td>23645-113</td> <td></td> <td>1000</td> <td>0,15 €</td> <td>0,18 €</td> <td></td> </tr> </tbody> </table>	REF	∅					23645-113		1000	0,15 €	0,18 €																													
REF	∅																																									
23645-113		1000	0,15 €	0,18 €																																						
Rollo Corredera Onda Perfecta Perfect wave runners roll / Rouleau de glisseur "onde parfaite"		<table border="1"> <thead> <tr> <th>REF</th> <th>∅</th> <th></th> <th></th> <th></th> <th></th> </tr> </thead> <tbody> <tr> <td>23645-114</td> <td></td> <td>1000</td> <td>0,15 €</td> <td>0,18 €</td> <td></td> </tr> </tbody> </table>	REF	∅					23645-114		1000	0,15 €	0,18 €																													
REF	∅																																									
23645-114		1000	0,15 €	0,18 €																																						
Rollo Corredera Onda Perfecta Perfect wave runners roll / Rouleau de glisseur "onde parfaite"		<table border="1"> <thead> <tr> <th>REF</th> <th>∅</th> <th></th> <th></th> <th></th> <th></th> </tr> </thead> <tbody> <tr> <td>23646-116</td> <td></td> <td>1000</td> <td>0,15 €</td> <td>0,18 €</td> <td></td> </tr> </tbody> </table>	REF	∅					23646-116		1000	0,15 €	0,18 €																													
REF	∅																																									
23646-116		1000	0,15 €	0,18 €																																						
Rollo Corredera Acordeón Corded gliders roll / Rouleau glisseurs acordeón		<table border="1"> <thead> <tr> <th>REF</th> <th>∅</th> <th></th> <th></th> <th></th> <th></th> </tr> </thead> <tbody> <tr> <td>23611-ACC</td> <td></td> <td>1000</td> <td>0,15 €</td> <td>0,18 €</td> <td></td> </tr> </tbody> </table>	REF	∅					23611-ACC		1000	0,15 €	0,18 €																													
REF	∅																																									
23611-ACC		1000	0,15 €	0,18 €																																						
Rollo Cinta Acordeón con Automáticos Ruffle-tape roll with snap-buttons / Rouleau ruban accordéon avec système automat		<table border="1"> <thead> <tr> <th>REF</th> <th>∅</th> <th></th> <th></th> <th></th> <th></th> </tr> </thead> <tbody> <tr> <td>23611-BCCO</td> <td></td> <td>1000</td> <td>0,20 €</td> <td>0,23 €</td> <td>100</td> </tr> </tbody> </table>	REF	∅					23611-BCCO		1000	0,20 €	0,23 €	100																												
REF	∅																																									
23611-BCCO		1000	0,20 €	0,23 €	100																																					
Cinta Armadora con 4 bolsas Buckram With 4 pouches / Ruban de monter avec 4 pouches		<table border="1"> <thead> <tr> <th>REF</th> <th>COLOR</th> <th>rollo (m) roll (m)</th> <th></th> <th></th> </tr> </thead> <tbody> <tr> <td>30178-0704B0CLA01200</td> <td>blanco/white</td> <td>200 m</td> <td>0,70 €/m</td> <td>70 mm</td> </tr> <tr> <td>30178-0704B0CLA02200</td> <td>beige</td> <td>200 m</td> <td>0,72 €/m</td> <td>70 mm</td> </tr> <tr> <td>30178-0904B0CLA01200</td> <td>blanco/white</td> <td>200 m</td> <td>0,94 €/m</td> <td>90 mm</td> </tr> <tr> <td>30178-0904B0CLA02200</td> <td>beige</td> <td>200 m</td> <td>0,96 €/m</td> <td>90 mm</td> </tr> <tr> <td>30178-1206B0CLA01100</td> <td>blanco</td> <td>100 m</td> <td>1,12 €/m</td> <td>120 mm</td> </tr> <tr> <td>30178-1206B0CLA02100</td> <td>beige</td> <td>100 m</td> <td>1,14 €/m</td> <td>120 mm</td> </tr> <tr> <td>30178-1206B0CLA03100</td> <td>transparente</td> <td>100 m</td> <td>1,16 €/m</td> <td>120 mm</td> </tr> </tbody> </table>	REF	COLOR	rollo (m) roll (m)			30178-0704B0CLA01200	blanco/white	200 m	0,70 €/m	70 mm	30178-0704B0CLA02200	beige	200 m	0,72 €/m	70 mm	30178-0904B0CLA01200	blanco/white	200 m	0,94 €/m	90 mm	30178-0904B0CLA02200	beige	200 m	0,96 €/m	90 mm	30178-1206B0CLA01100	blanco	100 m	1,12 €/m	120 mm	30178-1206B0CLA02100	beige	100 m	1,14 €/m	120 mm	30178-1206B0CLA03100	transparente	100 m	1,16 €/m	120 mm
REF	COLOR	rollo (m) roll (m)																																								
30178-0704B0CLA01200	blanco/white	200 m	0,70 €/m	70 mm																																						
30178-0704B0CLA02200	beige	200 m	0,72 €/m	70 mm																																						
30178-0904B0CLA01200	blanco/white	200 m	0,94 €/m	90 mm																																						
30178-0904B0CLA02200	beige	200 m	0,96 €/m	90 mm																																						
30178-1206B0CLA01100	blanco	100 m	1,12 €/m	120 mm																																						
30178-1206B0CLA02100	beige	100 m	1,14 €/m	120 mm																																						
30178-1206B0CLA03100	transparente	100 m	1,16 €/m	120 mm																																						
Blocacuerda de Plástico Cord-Lock / Frein-Corde Plástico		<table border="1"> <thead> <tr> <th>REF</th> <th>∅</th> <th></th> <th></th> <th></th> <th></th> </tr> </thead> <tbody> <tr> <td>23611-64</td> <td></td> <td>100</td> <td>0,66 €</td> <td>0,76 €</td> <td></td> </tr> </tbody> </table>	REF	∅					23611-64		100	0,66 €	0,76 €																													
REF	∅																																									
23611-64		100	0,66 €	0,76 €																																						
Rollo Cordón 3,5mm. Roll Cord / Rouleau Corde		<table border="1"> <thead> <tr> <th>REF</th> <th>∅</th> <th></th> <th></th> <th></th> <th></th> </tr> </thead> <tbody> <tr> <td>22611-036GR</td> <td>gris</td> <td>1</td> <td></td> <td>53,54 €</td> <td></td> </tr> <tr> <td>21626-035</td> <td>blanco</td> <td>1</td> <td></td> <td>66,40 €</td> <td></td> </tr> <tr> <td>23611-036BR</td> <td>bronce</td> <td>1</td> <td></td> <td>67,32 €</td> <td></td> </tr> </tbody> </table>	REF	∅					22611-036GR	gris	1		53,54 €		21626-035	blanco	1		66,40 €		23611-036BR	bronce	1		67,32 €																	
REF	∅																																									
22611-036GR	gris	1		53,54 €																																						
21626-035	blanco	1		66,40 €																																						
23611-036BR	bronce	1		67,32 €																																						

Caja de Ganchos

Tape Hook Box /
Anneau pour Rubans
Fronceurs



REF	∅	U	€	€ ¹	cm
45472-P(extrafuerte)		10 (cajas)	27,00 €	31,05 €	
45472-PE(D.400)		10 (cajas)	10 €	17,83 €	
45472-FR(D.401)		10 (cajas)	10 €	14,50 €	

Corredera con Ruedas

Wheeled Runner /
Glisseur Plastique



REF	∅	U	€	€ ¹	cm
23611-AC		1000	0,27 €/ud.	0,31 €	

Tensor

Cordweight /
Tendeur de
contrepoids

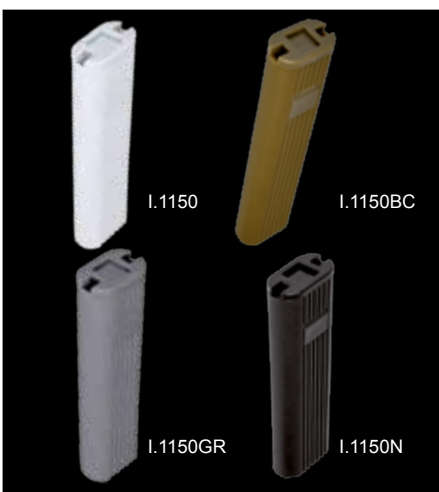

REF	∅	U	€	€ ¹	cm
22619-1150		25	1,48 €	1,78 €	
22619-1150BC		25	1,66 €	1,99 €	
22619-1150GR		25	1,66 €	1,99 €	
22619-1150N		25	1,66 €	1,99 €	

Tope

End-stop /
Vis avec écrou



REF	∅	U	€	€ ¹	cm
22643-08		10	0,24 €	0,28 €	

Muestra Riel Sintra

Demo Sample
Sintra track /
Échantillon
Rail Sintra



REF	∅	U	€	€ ¹	cm
80611-M1		1		24,10 €	40

Muestra Riel Obidos

Demo Sample
Obidos track /
Échantillon
Rail Obidos



REF	∅	U	€	€ ¹	cm
80615-M253		1		27,20 €	

Muestra Riel Coimbra

Demo Sample
Coimbra track /
Échantillon
Rail Coimbra



REF	∅	U	€	€ ¹	cm
80615-M254		1	-	29,48 €	

Ponemos a su disposición una amplia gama de fundas de cojín para darle un toque cálido y confortable a su hogar.



Cojín CAT



Cojín Coordinado Orleans



Cojín Elegance



Cojín Everest



Cojín Himalaya



Cojín Hojas



Cojín Love



Cojín Marina



Cojín Marta



Cojín Orleans



Cojín Questions



Cojín Wonder

Riel Decorativo Cilíndrico / Cylindrical Decorative Rail / Rail Décoratif Cylindrique

■ **Opción con Correderas**

Option with Gliders
Option avec Glisseurs



Wengué

Wenge



Plata Mate

Satin silver / Nickel satiné



Cerezo

Cherry / Merisier

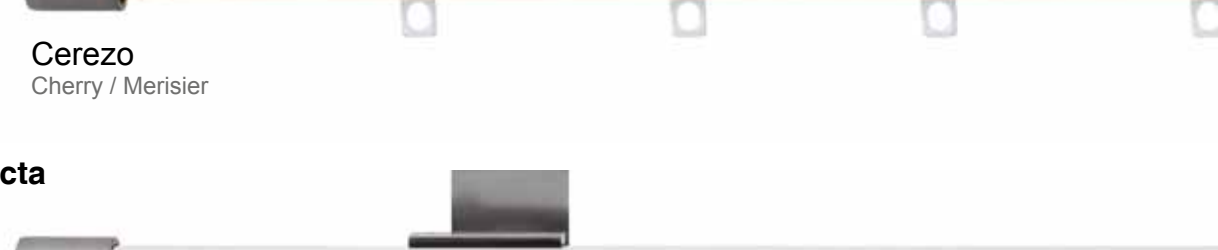

■ **Opción con Onda Perfecta**

Option with Perfect Wave
Option avec Onde Parfaite



Blanco

White / Blanc



Negro

Black / Noir

 Riel cilíndrico que simula una elegante Barra Decorativa, diferenciándose así del resto de rieles del mercado. La colección Córcega es el resultado de la unión de dos conceptos: por fuera es una auténtica barra decorativa, mientras que por dentro, es uno de los mejores rieles del mercado, capaz de albergar Correderas Normales y/o Correderas de "Onda Perfecta" (nuestro particular y económico sistema para garantizar una caída y una onda perfecta en toda cortina). El gran diseño y estilo del Riel Córcega, incluyendo sus resistentes Soportes, transmite elegancia y sencillez, convirtiéndolo en el Riel Ideal para decorar cualquier estancia donde la estética y el diseño sean lo principal.

 Cylindrical rail made of DM simulating an elegant decorative pole. This characteristic differs from the rest of the decorative rails of the market. The Córcega collection is the result of the union of two concepts: outside is a real decorative bar and inside is one of the best rails on the market, where can be used normal gliders but also ripple fold wave gliders to make the "perfect wave" (our economic system that ensures a perfect fall and a perfect wave on every curtain). The design and style of the rail Córcega, including its strong supports, provides elegance and simplicity, making this rail ideal for the decoration of any room where aesthetics and design are the most important.

 Rail cylindrique en DM simulant un tringle décorative et élégante. Cette caractéristique distingue ce rail du reste de rails décoratifs du marché. La collection Córcega est le résultat de l'union de deux concepts: l'extérieur est un tringle décorative et à l'intérieur a un des meilleurs rails sur le marché où peuvent être utilisés les glisseurs normales mais également les glisseurs pour ruban accordéon pour faire "l'onde parfaite" (notre système économique qui assure un tombé parfait et une onde parfaite à chaque rideau). Le design et le style du rail Córcega, compris ses solides supports, offre élégance et simplicité, ce qui fait le rail idéal pour la décoration de toute chambre où l'esthétique et le design sont les plus importants.

CÓRCEGA

Conjuntos completos "onda perfecta 23645-113" o corredera standard 23643-07"



Córcega Color Wengué / Wenge / Wenge



	REF						
D.113	23645-MPW240	2	32	-	1	128,26 €	244
	23645-MPW360	3	46	-	1	181,43 €	366
D.07	23645-MW240	2	-	26	1	124,46 €	244
	23645-MW360	3	-	38	1	175,49 €	366

Córcega Color Cerezo / Cherry / Merisier



	REF						
D.113	23645-MPC240	2	32	-	1	128,26 €	244
	23645-MPC360	3	46	-	1	181,43 €	366
D.07	23645-MC240	2	-	26	1	124,46 €	244
	23645-MC360	3	-	38	1	175,49 €	366

Córcega Color Plata Mate / Satin Silver / Nickel Satiné



	REF						
D.113	23645-MPP240	2	32	-	1	128,26 €	244
	23645-MPP360	3	46	-	1	181,43 €	366
D.07	23645-MP240	2	-	26	1	124,46 €	244
	23645-MP360	3	-	38	1	175,49 €	366

Córcega Color Blanco / White / Blanc



	REF						
D.113	23645-MPB240	2	32	-	1	128,26 €	244
	23645-MPB360	3	46	-	1	181,43 €	366
D.07	23645-MB240	2	-	26	1	124,46 €	244
	23645-MB360	3	-	38	1	175,49 €	366

Córcega Color Negro / Black / Noir



	REF						
D.113	23645-MPN240	2	32	-	1	128,26 €	244
	23645-MPN360	3	46	-	1	181,43 €	366
D.07	23645-MN240	2	-	26	1	124,46 €	244
	23645-MN360	3	-	38	1	175,49 €	366

Contenido del Kit / Kit components / Composants du Kit

🇪🇸 Conjuntos Sencillos (244 cm): 2 terminales, 2 soportes, perfil, tornillo tope y correderas.
 Conjuntos Sencillos (366 cm): 2 terminales, 3 soportes, tornillo tope, perfil y correderas.

🇬🇧 Single sets (244 cm): 2 finials, 2 brackets, track, end-stop & runners.
 Single sets (366 cm): 2 finials, 3 brackets, track, end-stop & runners.

🇫🇷 Kits simples (244cm): 2 embouts, 2 supports, rail, vis avec écrou et glisseurs.
 Kits simples (366 cm): 2 embouts, 3 supports, rail, vis avec écrou et glisseurs.

Posibilidades de montaje / Installation possibilities / Possibilités de montage



🇪🇸 El Riel Córcega permite combinar gracias a su soporte doble, un magnífico riel decorativo junto a un práctico riel técnico. En este ejemplo podemos ver la combinación de Riel Argent y Riel Córcega. Cualquier estancia se verá enriquecida con la elegante decoración del Riel Córcega, mientras que el Riel Argent aumenta sus posibilidades a la hora de buscar soluciones decorativas.

🇬🇧 The Córcega track offers the possibility of merging thanks to its special double bracket, one unique example of decorative splendor provided by the Córcega track together with the technical and practical nature of the Argent track. Any space will be enriched with the decorative elegance of the Córcega rail whereas the Argent rail will increase the possibilities regarding new decorative solutions.

🇫🇷 Le rail Córcega vous permet de fusionner grâce à son support double, un exemple unique de la splendeur décorative avec un rail technique et pratique. Dans cet exemple on peut vérifier la fusion du riel Argent et Córcega. N'importe quel espace sera enrichi avec l'élégance décorative du rail Córcega, tandis que le rail Argent augmente les chances d'obtenir nouvelles solutions décoratives.

Accesorios / Accesories / Accessoires



Perfil Córcega
 Córcega Profile /
 Córcega Rail

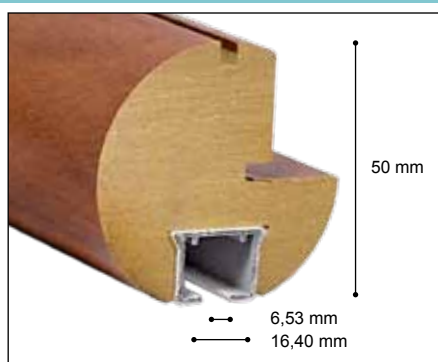

REF	-W	-C	-P	-B	-N	U	€	€	cm
23645-(color)244	-W	-C	-P	-B	-N	5	59,50 €	68,43 €	244
23645-(color)366	-W	-C	-P	-B	-N	5	87,38 €	100,49 €	366

Accesorios / Accessories / Accessoires



Tapón Acero

Steel Finial /
Bouchon Acier



REF	Ø	U	€	€	cm
23645-A12		10	7,50 €	8,63 €	

Soporte Frontal

Wall Bracket /
Support Mur

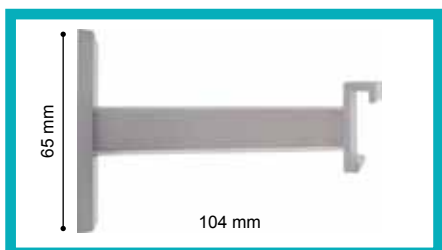

REF	Ø	U	€	€	cm
23645-AF		10	15,76 €	18,12 €	

* Soporte incluido en el Kit Sencillo /
Bracket supplied in the Single Kit / Support fourni dans le Simple Kit.

Soporte Frontal

Wall Bracket /
Support Mur

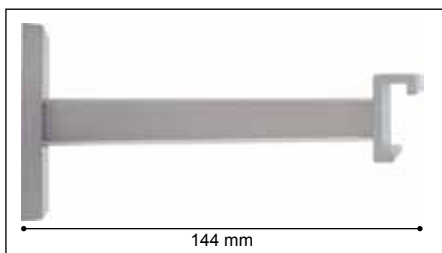

REF	Ø	U	€	€	cm
23645-AFG		10	18,40 €	21,16 €	

Soporte Techo

Ceiling Bracket /
Support plafond

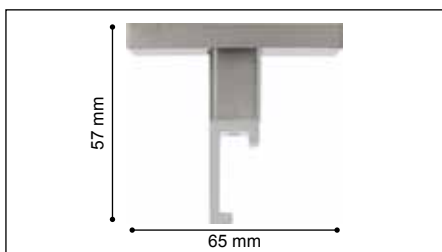

REF	Ø	U	€	€	cm
23645-ATE		10	16,52 €	19,00 €	

Soporte Doble

Double Wall
Bracket /
Support
Mur Double

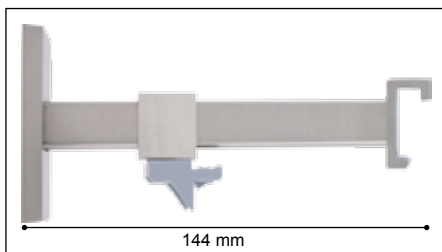

REF	Ø	U	€	€	cm
23645-AD		10	22,46 €	25,83 €	

Corredera

Runner /
lisseur



REF	Ø	U	€	€	cm
23643-07		500	0,08 €	0,092 €	

Rollo Corredera
Onda Perfecta

Perfect wave
runners roll /
Rouleau de glisseur
"onde parfaite"

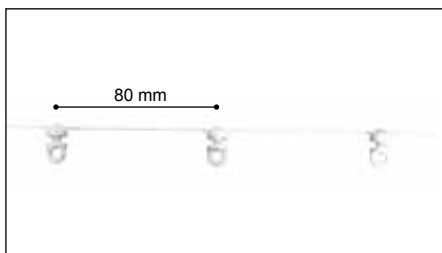

REF	Ø	U	€	€	cm
23645-113		1000	0,160 €	0,196 €	

Tornillo tope

End-Stop /
Vis avec
Écrou final



REF	∅	U	€	€ ¹	cm
22643-08		10	0,24 €	0,28 €	

Alargador
Soporte

Bracket extender /
Extendeur pour
bracket



REF	∅	U	€	€ ¹	cm
23645-2001AS		10	6,00 €	6,90 €	

Adaptador rieles
madera

Wood track
adaptador /
Adapteur pour rails
en bois



REF	∅	U	€	€ ¹	cm
23645-28		10	2,70 €	3,11 €	

Muestra
Riel Córcega

Demo Sample
Córcega track /
Échantillon
Rail Córcega



REF	∅	U	€	€ ¹	cm
80645-M251		1		21,42 €	



FUNDAS DE COJÍN

Ponemos a su disposición una amplia gama de fundas de cojín para darle un toque cálido y confortable a su hogar.



RIELES DECORATIVOS MARVENT

La combinación natural entre una barra y un riel
The natural match between pole and rail



Riel Decorativo Plano / Plain Decorative Rail / Rail Décoratif Plan

■ **Opción con Correderas**

Option with Gliders
Option avec Glisseurs



Wengué
Wenge



Plata Mate
Satin silver / Nickel satiné



Cerezo
Cherry / Merisier

■ **Opción con Onda Perfecta**

Option with Perfect Wave
Option avec Onde Parfait

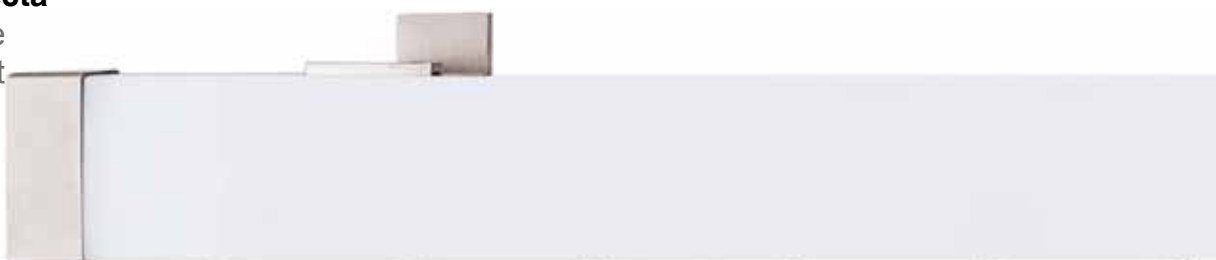

Blanco
White / Blanc



Negro
Black / Noir

 Riel rectangular que transmite modernidad y esmero por la decoración.

La colección Capri nos permite disfrutar de las ventajas de un riel de gran calidad y de la estética decorativa de una Barra de auténtico diseño, por ello su presencia en cualquier sala, lo hará destacar del resto de rieles existentes. Su adaptabilidad nos permitirá emplear cualquier tipo de corredera, desde las más básicas hasta la de onda perfecta (económico sistema para confeccionar cortinas con la onda perfecta) pasando por las cintas armadoras o las correderas de acordeón. Su uso en cualquier proyecto, garantiza la versatilidad y el éxito decorativo.

 Rectangular rail made of DM that transmits modernity and elegance in decoration.

The Capri collection allows to enjoy the benefits of a high quality rail together with the decoration of a design pole, so its presence in any room, differentiates from other existing rails. Its adaptability allow us to use any type of glider, from the most basic to the perfect wave (our economic system that ensures a perfect fall and a perfect wave on every curtain. Also can be used with all our range of buckram tapes). Every project where it will be used, its guaranteed with its versatility and decorative success.

 Rail rectangulaire en DM qui transmet la modernité et l'élégance dans la décoration.

La collection Capri permet de profiter des avantages d'un rail de haute qualité avec la décoration d'une tringle, de sorte que sa présence dans toutes les chambres le différencie des autres rails existants. Son adaptabilité permet d'utiliser les glisseurs normales mais également les glisseurs pour ruban accordéon pour faire "l'onde parfaite" (notre système économique qui assure un tombé parfait et une onde parfaite à chaque rideau). Est le rail idéal pour la décoration de toute chambre où l'esthétique et le design sont les plus importants.

Conjuntos completos "onda perfecta 23645-113"
o "corredera standard 23643-07"



Capri Color Wengué / Wenge / Wenge



	REF						
D.113	23463-MWP240	2	32	-	1	101,58 €	244
	23463-MWP360	3	46	-	1	143,31 €	366
D.07	23463-MW240	2	-	26	1	97,78 €	244
	23463-MW360	3	-	38	1	137,38 €	366

Capri Color Cerezo / Cherry / Merisier



	REF						
D.113	23463-MCP240	2	32	-	1	101,58 €	244
	23463-MCP360	3	46	-	1	143,31 €	366
D.07	23463-MC240	2	-	26	1	97,78 €	244
	23463-MC360	3	-	38	1	137,38 €	366

Capri Color Plata Mate / Satin Silver / Nickel Satiné



	REF						
D.113	23463-MPP240	2	32	-	1	107,81 €	244
	23463-MPP360	3	46	-	1	152,65 €	366
D.07	23463-MP240	2	-	26	1	104,01 €	244
	23463-MP360	3	-	38	1	146,72 €	366

Capri Color Blanco / White / Blanc



	REF						
D.113	23463-MBP240	2	32	-	1	107,81 €	244
	23463-MBP360	3	46	-	1	152,65 €	366
D.07	23463-MB240	2	-	26	1	104,01 €	244
	23463-MB360	3	-	38	1	146,72 €	366

Capri Color Negro / Black / Noir



	REF						
D.113	23463-MNP240	2	32	-	1	107,81 €	244
	23463-MNP360	3	46	-	1	152,65 €	366
D.07	23463-MN240	2	-	26	1	104,01 €	244
	23463-MN360	3	-	38	1	146,72 €	366

Contenido del Kit / Kit components / Composants du Kit

🇪🇸 Conjuntos Sencillos (244 cm): 2 terminales, 2 soportes, perfil, tornillo tope y correderas.
 Conjuntos Sencillos (366 cm): 2 terminales, 3 soportes, tornillo tope, perfil y correderas.

🇬🇧 Single sets (244 cm): 2 finials, 2 brackets, track, end-stop & runners.
 Single sets (366 cm): 2 finials, 3 brackets, track, end-stop & runners.

🇫🇷 Kits simples (244cm): 2 embouts, 2 supports, rail, vis avec écrou et glisseurs.
 Kits simples (366 cm): 2 embouts, 3 supports, rail, vis avec écrou et glisseurs.

Posibilidades de montaje / Installation possibilities / Possibilités de montage



🇪🇸 El Riel Capri permite combinar gracias a su perfil doble, un magnífico riel decorativo junto a un práctico riel técnico. En este ejemplo podemos ver la combinación de Riel Argent y Riel Capri. Cualquier estancia se verá enriquecida con la elegante decoración del Riel Capri, mientras que el Riel Argent aumenta sus posibilidades a la hora de buscar soluciones decorativas.

🇬🇧 The Capri track offers the possibility of merging thanks to its special double profile, one unique example of decorative splendor provided by the Capri track together with the technical and practical nature of the Argent track. Any space will be enriched with the decorative elegance of the Capri rail whereas the Argent rail will increase the possibilities regarding new decorative solutions.

🇫🇷 Le rail Capri vous permet de fusionner grâce à son profil double, un exemple unique de la splendeur décorative avec un rail technique et pratique. Dans cet exemple on peut vérifier la fusion du riel Argent et Capri. N'importe quel espace sera enrichi avec l'élégance décorative du rail Capri, tandis que le rail Argent augmente les chances d'obtenir nouvelles solutions décoratives.

Accesorios / Accessories / Accessoires

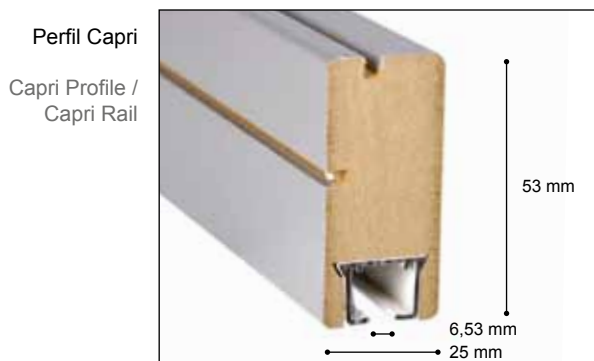

REF	-W	-C	-P	-B	-N	U	€	1	cm
23643-	-W	-C				5	36,30 €	41,75 €	244
23643-			-P	-B	-N	5	41,72 €	47,98 €	244
23643-	-W	-C				5	54,24 €	62,38 €	366
23643-			-P	-B	-N	5	62,36 €	71,71 €	366

Accesorios / Accesories / Accessoires



Tapón Acero

Steel Finial /
Bouchon Acier



REF	Ø	U	€	€	cm
23643-A011		10	7,50 €	8,63 €	

Soporte Frontal

Wall Bracket /
Support Mur

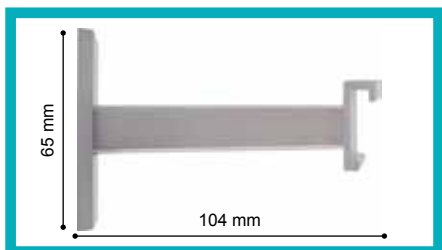

REF	Ø	U	€	€	cm
23645-AF		10	15,76 €	18,12 €	

* Soporte incluido en el Kit Sencillo
/ Bracket supplied in the Single Kit / Support fourni dans le Simple Kit.

Soporte Frontal

Wall Bracket /
Support Mur

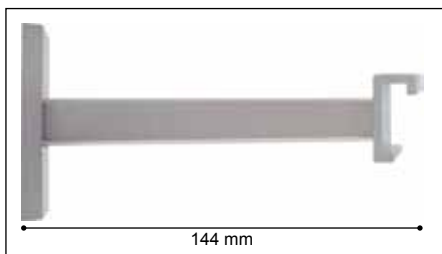

REF	Ø	U	€	€	cm
23645-AFG		10	18,40 €	21,16 €	

Soporte Techo

Ceiling Bracket /
Support plafond

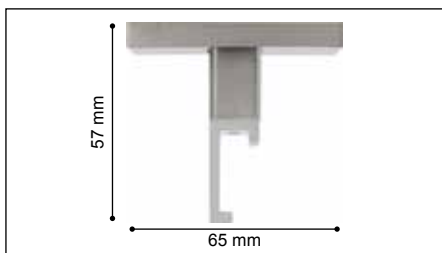

REF	Ø	U	€	€	cm
23645-ATE		10	16,52 €	19,00 €	

Soporte Doble

Double Wall
Bracket /
Support
Mur Double

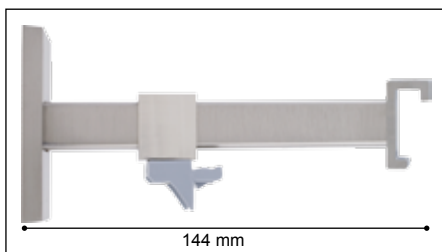

REF	Ø	U	€	€	cm
23645-AD		10	22,46 €	25,83 €	

Corredera

Runner /
lisieur



REF	Ø	U	€	€	cm
23643-07		500	0,08 €	0,092 €	

Rollo Corredera
Onda Perfecta

Perfect wave
runners roll /
Rouleau de glisseur
"onde parfaite"

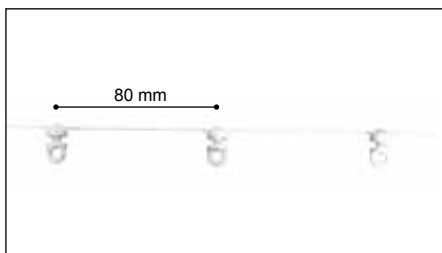

REF	Ø	U	€	€	cm
23645-113		1000	0,15 €	0,174 €	

Alargador Soporte

Bracket extender /
Extendeur pour
bracket



REF	∅	U	€	€	cm
23645-2001AS		10	6,00 €	6,90 €	

Adaptador rieles madera

Wood track
adaptador /
Adapteur pour rails
en bois



REF	∅	U	€	€	cm
23645-28		10	2,70 €	3,11 €	

Muestra Riel Capri

Demo Sample
Capri track /
Échantillon
Rail Capri



REF	∅	U	€	€	cm
80645-M250		1		21,42 €	

Tornillo tope

End-Stop /
Vis avec
Écrou final



REF	∅	U	€	€	cm
22643-08		10	0,24 €	0,28 €	

Marvent System somos la empresa profesional de confianza dedicada a ayudarte a decorar tus ventanas. Nuestra experiencia en el sector de la decoración con sistemas técnicos y de alta calidad está contrastada y avalada. Contáctenos sin compromiso.

Marvent
MARVENT SYSTEM S.L.

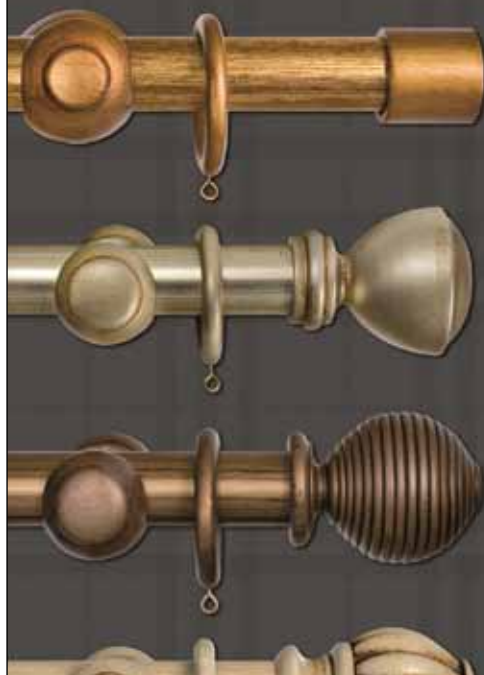

Marvent
MARVENT SYSTEM S.L.

barras de cortina
paneles japoneses
estores
rieles
motorizados
galerías
accesorios
ollaos



nueva
colección

CORTINAS TÉCNICAS

Protección solar creando zonas cálidas y confortables, embelleciendo el ambiente y dándole un toque personal a su casa.

Ponemos a su disposición catálogos y tarifas de precios de todos los productos.



Enrollables



Noche y Día



Impresión digital



Enrollables para puertas y ventanas



Verticales



Venecianas de madera



Venecianas de aluminio



Verticales de madera

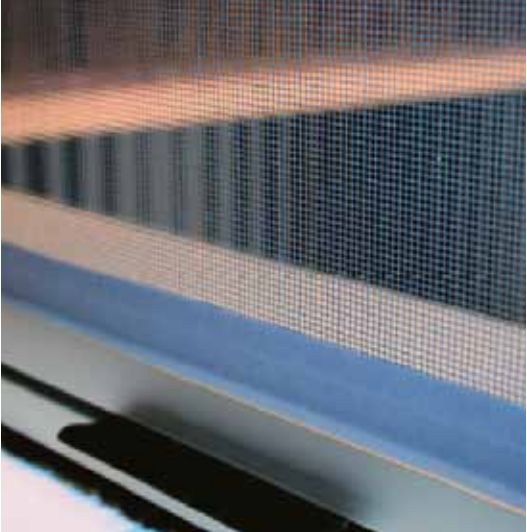

Mosquiteras

Riel Decorativo Plano / Plain Decorative Rail / Rail Décoratif Plan



Wengué
Wenge



Cerezo
Cherry / Merisier

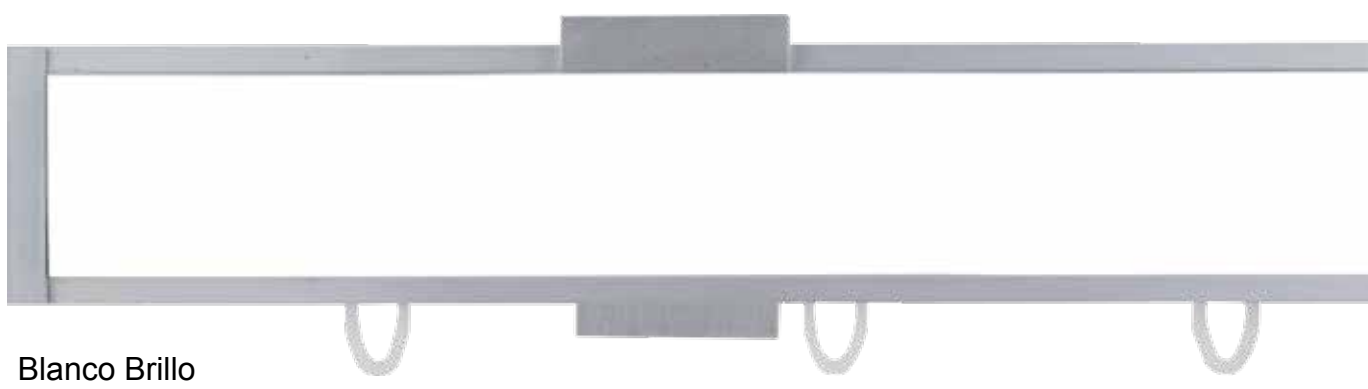



Blanco Brillo
Glossy White / Blanc Verni



Negro Brillo
Glossy Black / Noir Verni





 Riel funcional y moderno con melaminas de diseños intercambiables y adaptables a cualquier decoración. Con la Colección Inter damos un paso al frente para solucionar la creación de diferentes ambientes con un solo riel. Contamos con el aire moderno de su diseño que lo asemeja a una galería, también con la adaptabilidad del color para crear diferentes ambientes y además contamos, con un perfil que deja oculto el sistema de correderas. De este modo, podremos colocar cualquier cortina con cualquier sistema de corredera de la forma más simple y sencilla. Las melaminas (disponible para la venta también por piezas sueltas), permiten cambiar el color de la habitación en cualquier momento.

 Practical and modern rail, made of aluminium including different interchangeable decorative melamine that can match with all decorations. With Inter rail we take a step forward to solve different environments creations with one model of rail. The modern look of its design resembles it to a pelmet and the adaptability of colours allows to create different environments. Its particular profile system hides gliders so we can put any curtain very simply and easily. The melamine (also available for sale in spare parts) , gives us the chance to change the colour of the room at any time.

 Rail décoratif pratique et moderne, en aluminium avec différents mélamines décoratives interchangeables que peuvent reconstruire toutes les décorations. Avec le rail Inter nous faisons un pas en avant pour résoudre différents environnements de décoration. Le look moderne de son design ressemble à un bandeau et la capacité d'adaptation des couleurs permet de créer des environnements différents. Son système de profil particulier cache les glisseurs afin qu'est possible d'installer tout rideau très simplement et facilement. La mélamine (également disponible à la vente en pièces détachées), nous donne la possibilité de changer la couleur de la chambre à tout moment.

***Bajo pedido**

Conjuntos Completos INTER /
Complete sets INTER /
Kits complets INTER

 00AP Wengué Wenge Wenge	 01AP Cerezo Cherry Merisier	 02AP Blanco Brillo Glossy White Blanc Verni	 03AP Negro Brillo Glossy Black Noir Verni
---	---	---	---

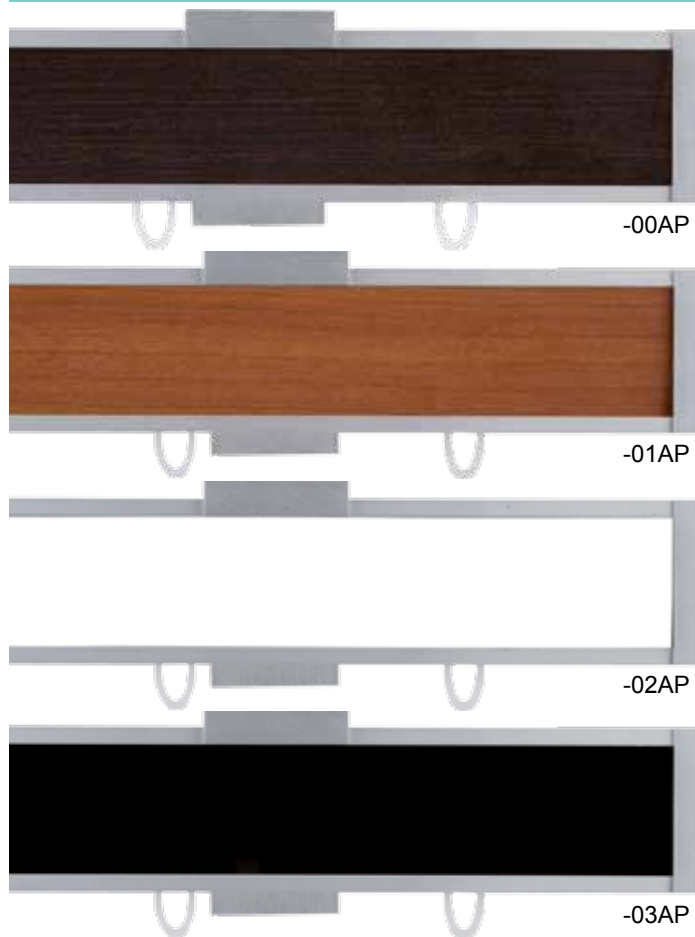



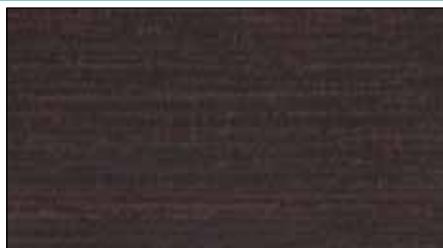

REF	-00AP	-01AP	-02AP	-03AP					
K.15811001-	-00AP	-01AP	-02AP	-03AP	2	10	1	102,11 €	100
K.15811501-	-00AP	-01AP	-02AP	-03AP	2	16	1	109,29 €	150
K.15812001-	-00AP	-01AP	-02AP	-03AP	2	20	1	116,28 €	200
K.15812501-	-00AP	-01AP	-02AP	-03AP	2	26	1	123,46 €	250
K.15813001-	-00AP	-01AP	-02AP	-03AP	3	30	1	161,20 €	300
*K.15813501-	-00AP	-01AP	-02AP	-03AP	3	36	1	187,67 €	350
*K.15814001-	-00AP	-01AP	-02AP	-03AP	3	40	1	194,66 €	400
*K.15814501-	-00AP	-01AP	-02AP	-03AP	3	46	1	201,84 €	450
*K.15815001-	-00AP	-01AP	-02AP	-03AP	3	50	1	208,83 €	500
*K.15815501-	-00AP	-01AP	-02AP	-03AP	3	56	1	216,01 €	550

Laminado Decorativo / Decorative laminales / Laminé Decoratif





Wengué
Wenge /
Wenge



REF					
V.100C0040		10	9,42 €	10,83 €	305





Cerezo
Cherry /
Merisier



REF					
V.101C0040		10	9,42 €	10,83 €	305





Blanco Brillo
Glossy White/
Blanc Verni

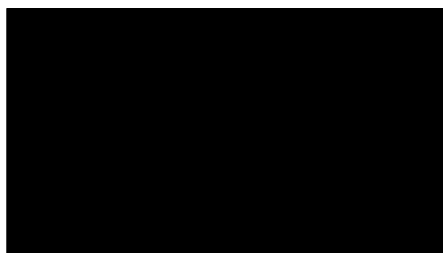

REF					
V.102C0040		10	9,42 €	10,83 €	305

Negro Brillo
Glossy Black /
Noir Verni



REF					
V.103C0040		10	9,42 €	10,83 €	305

***Bajo pedido**

Contenido del Kit / Kit components / Composants du Kit

🇪🇸 Conjuntos Sencillos : 2 terminales, 2 soportes, perfil de aluminio, tope y correderas.
Los conjuntos de 3 metros se sirven con 3 soportes.

🇬🇧 Single sets : 2 finials, 2 brackets, aluminium track, end-stop & runners.
All sets with a length 3 meters are supplied with 3 brackets.

🇫🇷 Kits simples : 2 embouts, 2 supports, rail aluminium, vis avec écrou et glisseur.
Tous les kits de plus de 3 mètres contiennent 3 supports.

* Se sirven empalmados.

* Supplied in 2 halve.

* Fourni en 2 parties.

Posibilidades de montaje / Installation possibilities / Possibilités de montage



🇪🇸 El Riel Inter permite combinar gracias a su perfil doble, un magnífico riel decorativo junto a un práctico riel técnico. En este ejemplo podemos ver la combinación de Riel Argent y Riel Inter. Cualquier estancia se verá enriquecida con la elegante decoración del Riel Inter, mientras que el Riel Argent aumenta sus posibilidades a la hora de buscar soluciones decorativas. /

🇬🇧 The Inter track offers the possibility of merging thanks to its special double profile, one unique example of decorative splendor provided by the Inter track together with the technical and practical nature of the Argent Track. Any space will be enriched with the decorative elegance of the Inter Rail whereas the Argent rail will increase the possibilities regarding new decorative solutions. /

🇫🇷 Le rail Inter vous permet de fusionner grâce à son profil double, un exemple unique de la splendeur décorative avec un rail technique et pratique. Dans cet exemple on peut vérifier la fusion du Riel Argent et Inter. N'importe quel espace sera enrichi avec l'élégance décorative du rail Inter, tandis que le rail Argent augmente les chances d'obtenir nouvelles solutions décoratives.

Accesorios / Accesories / Accessoires

Perfil Inter
Inter Profile /
Inter Rail



REF	∅	U	€	€	cm
C.12039AP		10	11,52 €/m	13,25 €/m	600

Tapa
Encap/
Bouchon



REF	∅	U	€	€	cm
D.84AP		10	6,56 €	7,54 €	

Corredera
Runner/
Glisseur



REF	∅	U	€	€	cm
22613-C		500	0,08 €	0,09 €	
22613-C		500	0,08 €	0,092 €	

*Bajo pedido

Accesorios / Accesories / Accessoires

Soporte Pared

Wall Bracket/
Support Mur

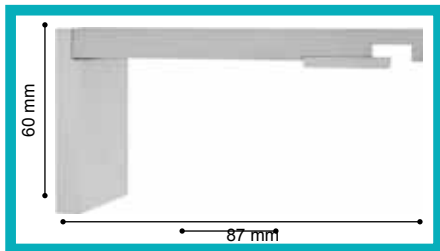

REF	∅	U	€	€	cm
N.120AP		10	26,74 €	30,75 €	

* Soporte incluido en el Kit Sencillo /
Bracket supplied in the Single Kit / Support fourni dans le Simple Kit.

Soporte Largo

Long Wall Bracket/
Support Mur Long

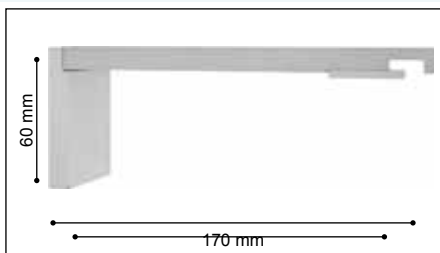

REF	∅	U	€	€	cm
N.122AP		10	33,24 €	38,23 €	

Soporte Doble

Double
Wall Bracket/
Support Mur Doble

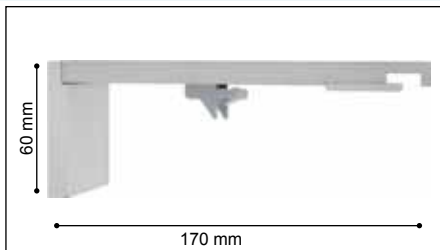

REF	∅	U	€	€	cm
O.122AP		10	33,24 €	38,23 €	

Soporte Techo

Ceiling Bracket/
Support Plafond

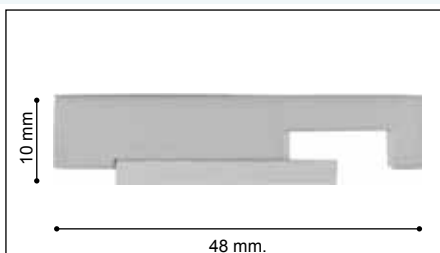

REF	∅	U	€	€	cm
N.121AP		10	14,90 €	17,14 €	

Soporte Techo

Ceiling Bracket/
Support Plafond



REF	∅	U	€	€	cm
D.50		50	2,06 €	2,37 €	

Empalme

Splice/
Raccordeur

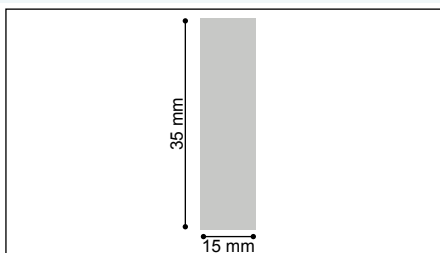

REF	∅	U	€	€	cm
D.820		10	7,36 €	8,46 €	

Tornillo Tope

End-Stop/
Vis Avec Écrou



REF	∅	U	€	€	cm
22643-08		10	0,24 €	0,28 €	

Muestra
Riel Inter

Demo Sample
Inter track /
Échantillon
Rail Inter



REF	∅	U	€	€	cm
M.252		1		42,84 €	

***Bajo pedido**

Riel Decorativo con iluminación LED / Rail with LED illumination / Rail Décoratif avec éclairage LED



Riel vanguardista, con iluminación interior, desarrollado con perfiles de primera calidad acrílicos y de aluminio. El Riel más innovador del mercado, el Riel de Led. Por un lado, es un sistema capaz de solucionar cualquier necesidad decorativa, por el otro, es el sistema de iluminación más avanzado que se puede encontrar. Gracias a este novedoso riel, podrá disfrutar de una acogedora luz cálida en la cabecera de sus cortinas. Le ayudará a decorar su hogar empleando la iluminación de tecnología led como elemento principal. El Riel de Led, está desarrollado pensando en cualquier uso o ubicación posible, por eso está fabricado con materiales de calidad que garantizan su seguridad y fiabilidad, además cuenta con Soportes capaces de adaptarse a todas las opciones de montaje.

Vanguardrail, with interior lighting, developed with high quality acrylic and aluminium materials. LEDS rail is the most innovative rail in the market. On the one hand, is a system able to solve any decorative need, on the other, is the most advanced lighting system that can be found. Thanks to this new track, you can enjoy a cosy warm light at the top of your curtains. It will help you to decorate your home using LED lighting technology as the main element. The Led rail is developed considering any use or possible location and it is manufactured with high quality materials to ensure safety and reliability. Moreover its supports are able to accommodate all installation options.

Avant-garde rail, avec lumière intérieur, élaboré avec matériel acrylique et d'aluminium de haute qualité. LEDS est le rail le plus innovateur sur le marché qui est capable de résoudre toutes les besoins de décoration avec un système de lumière très avancé. Merci à cette rail, vous pourrez profiter d'une lumière chaude et confortable en haut de vos rideaux. Il vous aidera à décorer votre maison en utilisant la technologie LED comme l'élément principal. Le rail LED est fabriqué avec des matériaux de haute qualité pour assurer la sécurité et la fiabilité. De plus ses supports ont été développés en mesure de s'adapter à toutes les options d'installation.

Contenido del Kit / Kit components / Composants du Kit



Contenido Kit

Perfil de aluminio, riel de metacrilato, leds, 2 tapas, transformador y cable de conexión.
Aluminium profile, acrylic profile, led strips, 2 endcaps adaptor & cord connector.
Rail en aluminium, profil acrilique, tiges de leds, 2 bouchons, transformateur & câble de connexion.

Es recomendable utilizar 3 soportes en conjuntos de más de 2 m.
It is advisable to use 3 brackets in lengths over 2 meters.
Il est recommandable d'utiliser 3 support pour des garnitures de plus de 2 mètres.

Información General / General Information / Informations Générales

- Los "leds" son diodos semiconductores que consumen aproximadamente un 75% menos energía que las bombillas/tubos convencionales de iluminación.
- Emiten muy poco calor con lo cual no dañan ni queman los objetos cercanos.
- Son muy duraderos al no tener piezas móviles y resisten muy bien los golpes.
- Al no contener mercurio, a diferencia de los sistemas convencionales, no son perjudiciales para el medio ambiente.
- La duración media de los leds es de 20.000 horas de luz, en condiciones normales de uso.

- Leds are semi-conductor diodes that consume approximately 75% less energy than conventional light bulbs/tubes.
- They produce very little heat and therefore do not harm objects that are near them.
- They are very durable because they do not contain movable parts and they are highly shock-resistant.
- Contrary to other conventional lighting systems, they do not contain mercury so they are not harmful to the environment.
- The average life of the leds strips is 20.000 light hours under normal conditions of use.

- Les leds sont des diodes semi-conductives qui consomment en moyenne 75% moins d'énergie que des ampoules traditionnelles.
- Elles émettent très peu de chaleur, elles ne produisent donc aucun dommage aux objets aux alentours.
- Elles sont très solides et résistent aux coups.
- Comme elles ne contiennent pas de mercure, elles ne sont pas nocives pour l'environnement.
- La durée moyenne de vie d'une led est de 20.000 heures de lumières dans des conditions d'utilisations normales.

***Bajo pedido**

Accesorios / Accesories / Accessoires

Kit Riel Leds

Leds track kit /
Kit rail Leds

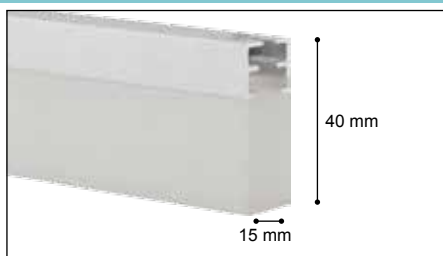

REF	∅	U	€	€	cm
J.F4200		1		292,40 €	200
J.F4300		1		405,72 €	300

Soporte Frontal

Wall bracket /
Support mur

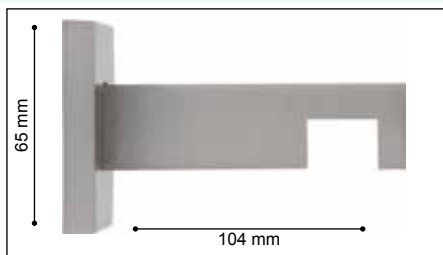

REF	∅	U	€	€	cm
J.F400		10	16,26 €	18,70 €	

Soporte Largo

Long wall bracket /
Support mur long

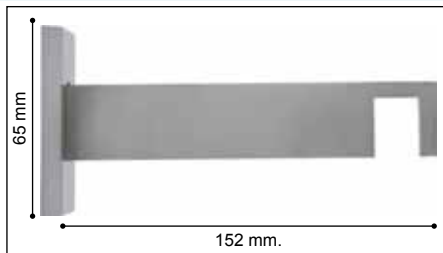

REF	∅	U	€	€	cm
J.F409		10	18,24 €	20,98 €	

Soporte Techo

Ceiling bracket /
Support plafond

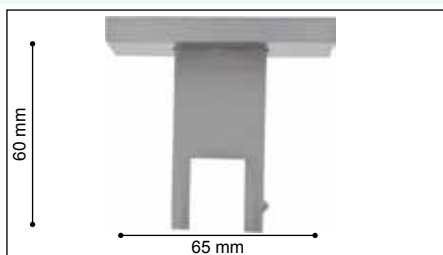

REF	∅	U	€	€	cm
J.F401		10	14,54 €	16,72 €	

Soporte Doble

Double wall bracket /
Support mur double

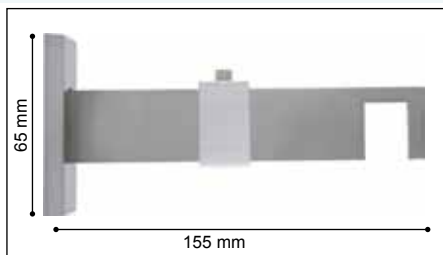

REF	∅	U	€	€	cm
J.F402		10	20,98 €	24,13 €	

Tapas Acero

Steel endcaps /
Bouchons acier

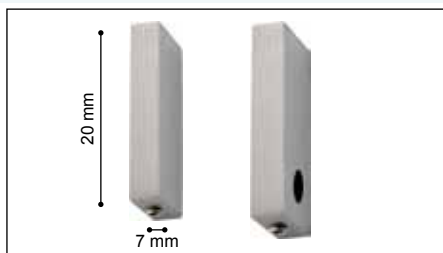

REF	∅	U	€	€	cm
J.F403		10	14,72 €/par	16,93 €/par	

Anilla

Ring /
Anneaux

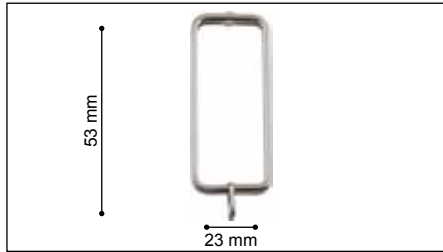

REF	∅	U	€	€	cm
J.F404		100	1,68 €	1,93 €	

Tira de Leds

Led strips /
Tiges de Leds



REF	∅	U	€	€	cm
J.F405		10	32,68 €	37,58 €	50

***Bajo pedido**

Precios de venta recomendados. IVA no incluido / S.R.P.: Suggested Retail Prices / Prix detail Conseillés

Transformador

AC Adaptor /
Transformateur



REF	∅	U	€	€	cm
J.F407		1		28,18 €	

Cable de conexión

Connector cord /
Câble de connexion



REF	∅	U	€	€	cm
J.F406		10	4,26	4,90 €	

Interruptor de techo

Ceiling switch /
Interrupteur
du plafond



REF	∅	U	€	€	cm
J.F408		10	11,18 €	12,86 €	

Embellecedor soporte
leds para interruptor

Decorative
bracket cover /
Revêtement
décoratif



REF	∅	U	€	€	cm
J.F410		10	18,24 €	20,98 €	



RAIL LED
 lighting your home
 lighting your life

un nuevo concepto en
 decoración:
 Riel con Luz Led

Marvent
 SOLUCIONES PARA DECORAR VENTANAS

***Bajo pedido**

Precios de venta recomendados. IVA no incluido / S.R.P.: Suggested Retail Prices / Prix detail Conseillés

**Opciones de montaje:**

- Correderas
- Onda perfecta
- Anillas

Riel SLIM:

El riel decorativo de Aluminio Cepillado, mejor acabado y con más gramos de aluminio por metro.

www.marvent.es

■ **Opción con Corredera Onda Perfecta - Base: (23646-CB121 o 23646-CB122 Corredera para base 23646-CB120) /**

Option Perfect Wave Gliders /

Option avec Glisseurs Onde Parfaite

Tapón

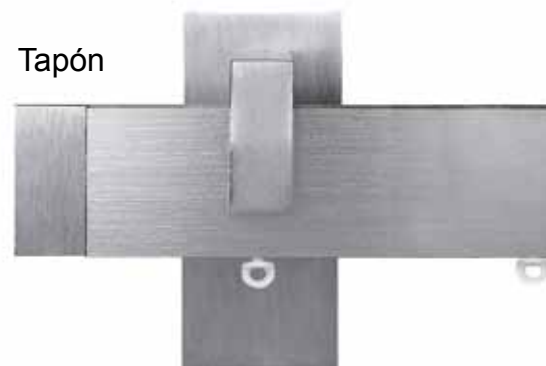

■ **Opción con correderas (23646-CCHU) /**

Option with gliders /

Option avec glisseurs

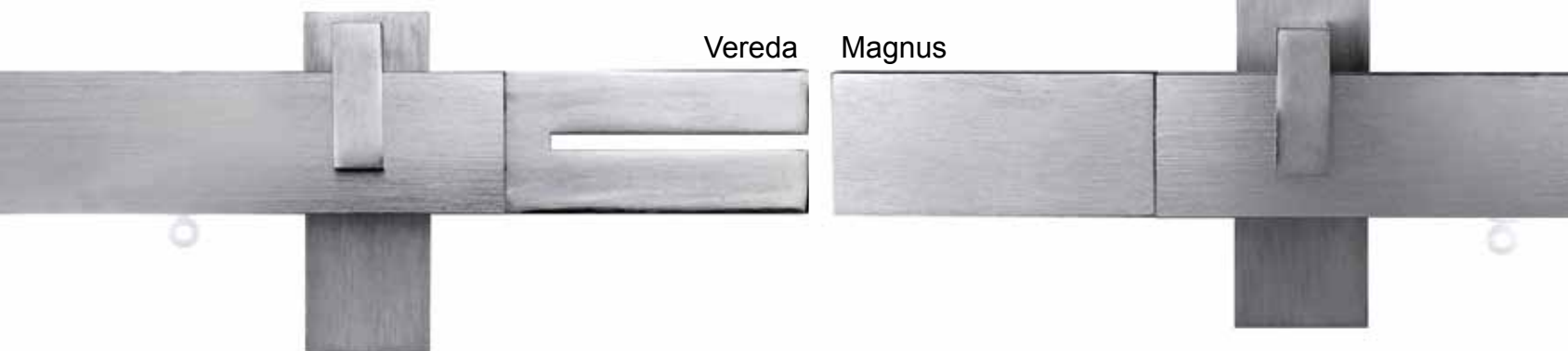

■ **Opción con Anillas (23646-AA) /**

Option with rings /

Option avec anneaux



 Riel de interior y exterior, con acabado en aluminio cromatizado de aspecto cepillado que le da un toque realmente diferente de alto valor estético.

Sin lugar a dudas, es el Riel moderno por excelencia y a la vez, es una barra decorativa si se instala con anillas. Su estética y su diseño, el acabado de sus detalles y el tratamiento del color, hacen de este riel, un riel para los más exigentes.

Cuenta además con soportes de alto valor decorativo que permiten cualquier tipo de instalación que necesite.

 Indoor and outdoor coated track with an original brushed-aluminum finish offering a "different touch" of unquestionable aesthetic value.

Undoubtedly, it is the quintessential modern rail, and at the same time is a decorative pole when used with its modern rectangular rings. His design, finish detail and colour treatment make this rail, a rail for the most demanding. It also has high decorative value brackets that allow any installation need.

Available in steel colour and in three lengths.

 Rail pour intérieur et extérieur, en aluminium finition brossée qui apporte une touche vraiment différente de haute valeur esthétique.

Sans aucun doute, c'est le rail moderne par excellence, et en même temps est un tringle décorative quand il est utilisé avec les anneaux rectangulaires modernes. Sa conception, le détail de sa finition et le traitement des couleurs font de ce rail, un rail pour les plus exigeants.

Il a également supports de haute valeur décorative qui permettent tout besoin d'installation.

SLIM

Conjuntos Sencillos completos. Opción con “Corredera 23646-CCHU” o “Anilla 23646-AA” /
 Complete Single sets. Option with “gliders D.998” or “Rings H.02AC” /
 Kits Simples complets. Option avec “glisseurs D.998” ou “Anneaux H.02AC”

Guía



	REF						
D.998	K.13100150AC	2	16	-	1	80,30 €	150
	K.13100200AC	2	20	-	1	90,11 €	200
	K.13100300AC	3	30	-	1	124,31 €	300
H.02AC	K.13000150AC	2	-	16	1	140,02 €	150
	K.13000200AC	2	-	20	1	165,09 €	200
	K.13000300AC	3	-	30	1	237,45 €	300

Cova



	REF						
D.998	K.13500150AC	2	16	-	1	80,30 €	150
	K.13500200AC	2	20	-	1	90,11 €	200
	K.13500300AC	3	30	-	1	124,31 €	300
H.02AC	K.13400150AC	2	-	16	1	140,02 €	150
	K.13400200AC	2	-	20	1	165,09 €	200
	K.13400300AC	3	-	30	1	237,45 €	300

Vereda



	REF						
D.998	K.13300150AC	2	16	-	1	80,30 €	150
	K.13300200AC	2	20	-	1	90,11 €	200
	K.13300300AC	3	30	-	1	124,31 €	300
H.02AC	K.13200150AC	2	-	16	1	140,02 €	150
	K.13200200AC	2	-	20	1	165,09 €	200
	K.13200300AC	3	-	30	1	237,45 €	300

Magnus



	REF						
D.998	K.12900150AC	2	16	-	1	80,30 €	150
	K.12900200AC	2	20	-	1	90,11 €	200
	K.12900300AC	3	30	-	1	124,31 €	300
H.02AC	K.12800150AC	2	-	16	1	140,02 €	150
	K.12800200AC	2	-	20	1	165,09 €	200
	K.12800300AC	3	-	30	1	237,45 €	300

Tapón



	REF						
D.998	K.13700150AC	2	16	-	1	70,78 €	150
	K.13700200AC	2	20	-	1	80,59 €	200
	K.13700300AC	3	30	-	1	114,79 €	300
H.02AC	K.13600150AC	2	-	16	1	130,50 €	150
	K.13600200AC	2	-	20	1	155,57 €	200
	K.13600300AC	3	-	30	1	227,93 €	300

Conjuntos Dobles completos. Opción con "Corredera 23646-CCHU" o "Anilla 23646-AA" /
 Complete Double sets. Option with "gliders D.998" or "Rings H.02AC" /
 Kits Doubles complets. Option avec "glisseurs D.998" ou "Anneaux H.02AC"

Guía



	REF						
D.998	K.13122150AC	2	32	-	1	138,71 €	150
	K.13122200AC	2	40	-	1	158,33 €	200
	K.13122300AC	3	60	-	1	215,78 €	300
H.02AC	K.13022150AC	2	-	32	1	258,15 €	150
	K.13022200AC	2	-	40	1	308,29 €	200
	K.13022300AC	3	-	60	1	442,06 €	300

Cova



	REF						
D.998	K.13522200AC	2	32	-	1	138,71 €	150
	K.13522300AC	2	40	-	1	158,33 €	200
	K.13422150AC	3	60	-	1	215,78 €	300
H.02AC	K.13422200AC	2	-	32	1	258,15 €	150
	K.13422300AC	2	-	40	1	308,29 €	200
	K.13422300AC	3	-	60	1	442,06 €	300

Vereda



	REF						
D.998	K.13322150AC	2	32	-	1	138,71 €	150
	K.13322200AC	2	40	-	1	158,33 €	200
	K.13322300AC	3	60	-	1	215,78 €	300
H.02AC	K.13222150AC	2	-	32	1	258,15 €	150
	K.13222200AC	2	-	40	1	308,29 €	200
	K.13222300AC	3	-	60	1	442,06 €	300

Magnus



	REF						
D.998	K.12922150AC	2	32	-	1	138,71 €	150
	K.12922200AC	2	40	-	1	158,33 €	200
	K.12922300AC	3	60	-	1	215,78 €	300
H.02AC	K.12822150AC	2	-	32	1	258,15 €	150
	K.12822200AC	2	-	40	1	308,29 €	200
	K.12822300AC	3	-	60	1	442,06 €	300

Tapón



	REF						
D.998	K.13722150AC	2	32	-	1	119,67 €	150
	K.13722200AC	2	40	-	1	139,28 €	200
	K.13722300AC	3	60	-	1	196,74 €	300
H.02AC	K.13622150AC	2	-	32	1	239,11 €	150
	K.13622200AC	2	-	40	1	289,25 €	200
	K.13622300AC	3	-	60	1	423,02 €	300

Opción Onda perfecta: Base: (23646-CB121 o 23646-CB122) + corredera para base 23646-CB120

Diferencia de Precio por Onda perfecta.

Price difference with the option of runner D.120 for base cord.

Différence de prix avec l'option de coulisse D.120 pour cordon de base.

Precios PVP

SRP Price

Prix PVP

REF	 60 mm	REF	 80 mm
23646-CB60150	11,14 €	23646-CB80150	9,94 €
23646-CB60200	15,24 €	23646-CB80200	13,02 €
23646-CB60300	22,52 €	23646-CB80300	18,94 €
23646-DCB60150	22,28 €	23646-DCB80150	19,88 €
23646-DCB60200	31,38 €	23646-DCB80200	26,04 €
23646-DCB60300	45,04 €	23646-DCB80300	37,86 €

Contenido del Kit / Kit components / Composants du Kit

 Conjuntos Sencillos : 2 terminales, 2 soportes, perfil de aluminio, tope y correderas o anillas.
 Conjuntos Dobles : 2 terminales, 2 soportes, perfil de aluminio, tope y correderas o anillas.
 Los conjuntos de 3 metros se sirven con 3 soportes.

 Single Sets : 2 finials, 2 brackets, aluminium track, end-stop & runners or rings.
 Double Sets : 2 finials, 2 brackets, aluminium track, end-stop & runners or rings.
 All sets with a length 3 meters are supplied with 3 brackets.

 Kits Simples : 2 embouts, 2 supports, rail aluminium, vis avec écrou et glisseur ou anneaux.
 Kits Doubles : 2 embouts, 2 supports, rail aluminium, vis avec écrou et glisseur ou anneaux..
 Tous les kits de plus de 3 mètres contiennent 3 supports.

Accesorios / Accesories / Accessoires

Perfil Aluminio Aluminium Track / Rail Aluminium		REF					
		23646-A150		10	23,40 €	26,91 €	150
		23646-A200		10	31,52 €	36,25 €	200
		23646-A300		10	46,78 €	53,80 €	300
Terminal Guía finial / embout		REF					
		23646-AG		10	8,36 €	9,61 €	
Terminal Cova finial / embout		REF					
		23646-AC		10	8,36 €	9,61 €	
Terminal Vereda finial / embout		REF					
		23646-AV		10	8,36 €	9,61 €	

Accesorios / Accessories / Accessoires

Terminal
Magnus

finial /
embout

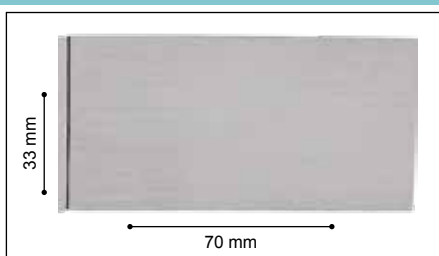

REF	∅	U	€	€ ¹	cm
23646-AM		10	8,36 €	9,61 €	

Terminal
Tapón

finial /
embout

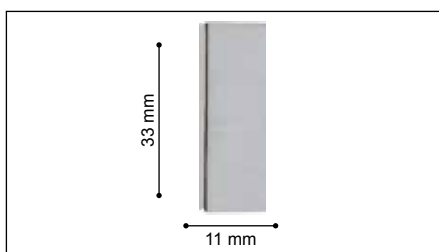

REF	∅	U	€	€ ¹	cm
23646-ATO		10	4,22 €	4,85 €	

Empalme

Splice /
Raccordeur

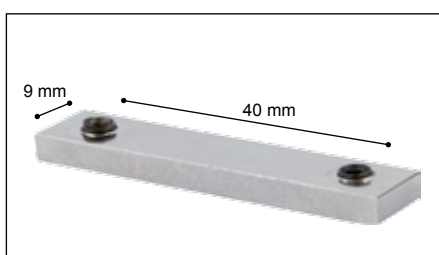

REF	∅	U	€	€ ¹	cm
23646-AE		10	4,88 €	5,61 €	

Soporte Pared

Wall Bracket /
Support Mur

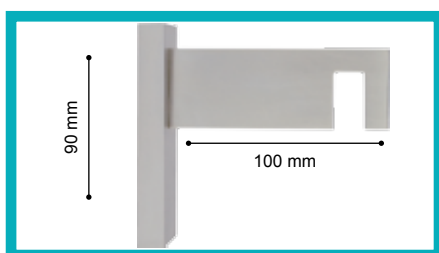

REF	∅	U	€	€ ¹	cm
23646-AF		10	13,46 €	15,48 €	

* Soporte incluido en el Kit Sencillo /
Bracket supplied in the Single Kit / Support fourni dans le Simple Kit.

Soporte Doble
Pared

Double Wall
Bracket /
Support Mur
Double

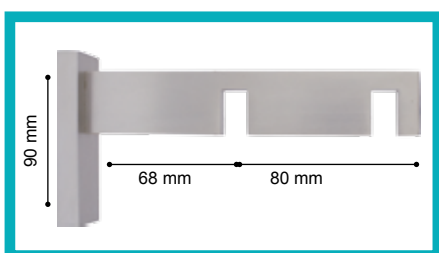

REF	∅	U	€	€ ¹	cm
23646-ADF		10	17,40 €	20,01 €	

Alargador Soporte

Extender /
Prolongateur

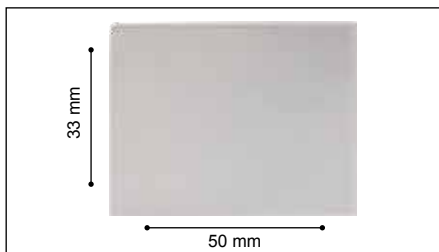

REF	∅	U	€	€ ¹	cm
23646-2000		10	4,00 €	4,60 €	

Soporte techo

Ceiling bracket /
Support plafond



REF	∅	U	€	€ ¹	cm
23646-AT		10	4,04 €	4,65 €	

Accesorios / Accesories / Accessoires

Anilla
Ring /
Anneaux

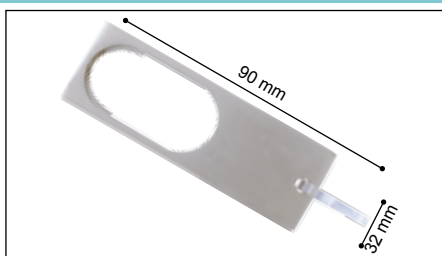

REF	∅	U	€	€	cm
23646-AA		100	3,42 €	3,93 €	

Corredera Tope
Static end Runner /
Glisseur Flixe



REF	∅	U	€	€	cm
D.781		100	0,68 €	0,78 €	

Corredera plástico
Static en Runner /
Glisseur Flixe



REF	∅	U	€	€	cm
23646-CCHU		100	0,11 €	0,13 €	

Corredera para
Cordón Base

Runners
for base cord /
Coulisses
pour cordon
de base



REF	∅	U	€	€	cm
23646-CB120		110	0,20 €	0,23 €	

100 m Rollo Base
Corredera Cordón
con paso 60 mm
100 m Roll of base cord
for runner, cord with
spacing 60 mm /
100 m Rouleau
de cordon de base
pour coulisse, cordon
avec pas 60 mm

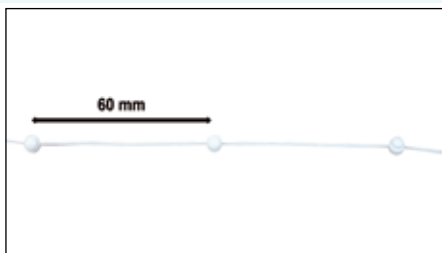

REF	∅	U	€	€	cm
23646-CB121		1660	0,24 €	0,28 €	

100 m Rollo Base
Corredera Cordón
con paso 80 mm
100 m Roll of base
cord for runner, cord with
spacing 80 mm /
100 m Rouleau
de cordon de base
pour coulisse, cordon
avec pas 80 mm

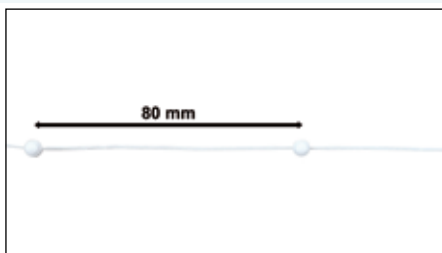

REF	∅	U	€	€	cm
23646-CB122		1250	0,24 €	0,37 €	

Expositor
Reil Slim

Slim Track Display
Board /
Presentoir
Rail Slim



REF	∅	U	€	€	cm
M.3008		-	-	102,82 €	

Barras Modernas

modern collection / collection moderne



Marvent

SOLUCIONES PARA DECORAR VENTANAS



Marvent

SOLUCIONES PARA DECORAR VENTANAS

colección barra de cortina

INFINITY VANITY

engarzado con cristales originales de Swarovski®



Barra de Cortina INFINITY ZEN / Curtain Pole INFINITY ZEN / Tringle a rideau INFINITY ZEN



Ángulo negro

Infinity es la colección con un acabado en acero inoxidable más atractiva, amplia, versátil y funcional del mercado.

Le presentamos una colección completísima basada en una barra de primera calidad, anillas y diferentes terminales que cubren infinitas tendencias decorativas formando subcolecciones.

Infinity is the most attractive, versatile and functional stainless steel collection in the market with a very wide range of finials and brackets. It is a complete collection based on a high quality materials including a very wide range of brackets and accessories for any installation required, high quality poles, design rings and a wide range of design finials forming endless decorative trends subcollections.

Infinity est la collection avec finition acier plus intéressante, polyvalente et fonctionnelle sur le marché avec une gamme très large d'embouts et supports.

Elle est une collection complète fabriquée avec matériels de haute qualité contenant une très large gamme de supports et accessoires pour toutes les installations. La combinaison des tringles de haute qualité, les anneaux, la gamme de supports et la large gamme d'embouts permettent décorations différentes presque sans fin.



Ángulo blanco



Olas negro



Trazos

Infinity ZEN sigue un estilo gráfico basado en formas, trazos y grecas, combinando blancos, negros y acero para dar lugar a una colección muy sofisticada.

Infinity ZEN is a graphic style based on shapes, lines and frets, combining white, black and steel and the result is a very sophisticated collection.

Infinity ZEN est un style graphique basé sur les formes, les lignes et les frettes combinant blanc, noir et acier donne comme résultat une collection très sophistiquée.

INFINITY ZEN

Conjuntos completos ZEN /
Complete sets ZEN /
Kits complete ZEN



Negro
Black
Noir



Blanco
White
Blanc



Acero
Steel
Acier

Ángulo Negro



	Ø 19 REF K.8318AB	Ø 30 REF K.8307AB	Ø 19/19 REF K.8319AB	Ø 30/19 REF K.8321AB		cm
1	115,58 €	154,65 €	192,37 €	237,43 €	16	150
1	125,17 €	169,81 €	211,55 €	262,18 €	20	200
1	157,55 €	216,45 €	256,93 €	324,81 €	26	250
1	166,54 €	231,89 €	274,92 €	349,23 €	30	300
1	191,08 €	271,95 €	324,00 €	413,84 €	40	400

Ángulo Blanco



	Ø 19 REF K.8218ABL	Ø 30 REF K.8207ABL	Ø 19/19 REF K.8219ABL	Ø 30/19 REF K.8221ABL		cm
1	115,58 €	154,65 €	192,37 €	237,43 €	16	150
1	125,17 €	169,81 €	211,55 €	262,18 €	20	200
1	157,55 €	216,45 €	256,93 €	324,81 €	26	250
1	166,54 €	231,89 €	274,92 €	349,23 €	30	300
1	191,08 €	271,95 €	324,00 €	413,84 €	40	400

Olas Negro



	Ø 19 REF K.8418AB	Ø 30 REF K.8407AB	Ø 19/19 REF K.8419AB	Ø 30/19 REF K.8421AB		cm
1	117,65 €	156,72 €	196,51 €	241,57 €	16	150
1	127,24 €	171,88 €	215,69 €	266,32 €	20	200
1	159,62 €	218,52 €	261,07 €	328,95 €	26	250
1	168,61 €	233,96 €	279,06 €	353,37 €	30	300
1	193,15 €	274,02 €	328,14 €	417,98 €	40	400

Trazos Blanco



	Ø 19 REF K.8118ABL	Ø 30 REF K.8107ABL	Ø 19/19 REF K.8119ABL	Ø 30/19 REF K.8121ABL		cm
1	115,58 €	154,65 €	192,37 €	237,43 €	16	150
1	125,17 €	169,81 €	211,55 €	262,18 €	20	200
1	157,55 €	216,45 €	256,93 €	324,81 €	26	250
1	166,54 €	231,89 €	274,92 €	349,23 €	30	300
1	191,08 €	271,95 €	324,00 €	413,84 €	40	400



Cavity acero



Cavity naranja



Cavity amarillo



Cavity negro



Cavity azul



Cavity rojo



Cavity blanco



Cavity verde



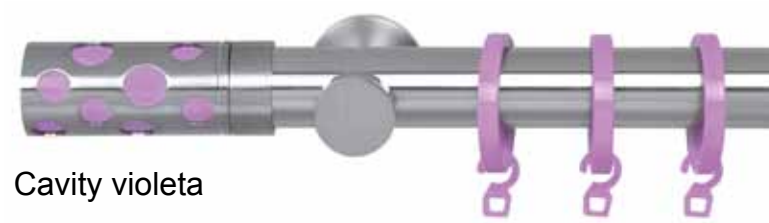

Cavity gris



Cavity violeta

 Infinity COLORS con todas sus opciones cromáticas, explota la alegría que transmiten los colores pudiendo combinar perfectamente en cualquier habitación.

 Infinity COLORS with a full choice of colours, exploits the joy that transmit the colours to match perfectly into any colour decoration room.

 Infinity COLORS avec un choix plein de couleurs, exploite la joie qui transmettent les couleurs pour correspondre parfaitement dans toutes les



Tapón acero



Tapón naranja



Tapón amarillo



Tapón negro

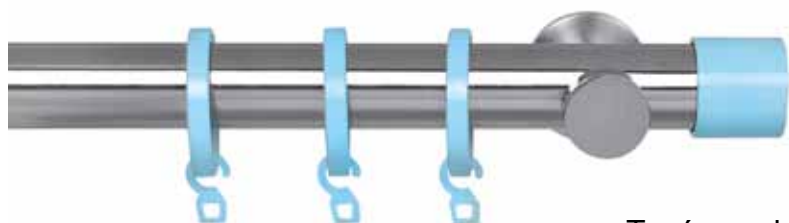

Tapón azul



Tapón rojo



Tapón Blanco



Tapón verde



Tapón gris



Tapón violeta

Ø 19 / 30 mm



∅ 19 / 30 mm

INFINITY COLORS

Conjuntos completos COLORS /
Complete sets COLORS /
Kits complete COLORS



Cavity Acero



U	Ø 19 REF K.8618A	Ø 30 REF K.8607A	Ø 19/19 REF K.8619A	Ø 30/19 REF K.8621A	Q	cm
1	95,34 €	140,35 €	151,89 €	202,88 €	16	150
1	104,93 €	155,50 €	171,07 €	227,63 €	20	200
1	137,31 €	202,15 €	216,45 €	290,26 €	26	250
1	146,30 €	217,58 €	234,44 €	314,69 €	30	300
1	170,84 €	257,65 €	283,52 €	379,29 €	40	400

Tapón Acero



U	Ø 19 REF K.6318A	Ø 30 REF K.6307A	Ø 19/19 REF K.6319A	Ø 30/19 REF K.6321A	Q	cm
1	81,49 €	119,23 €	124,20 €	167,92 €	16	150
1	91,08 €	134,39 €	143,38 €	192,67 €	20	200
1	123,46 €	181,03 €	188,76 €	255,30 €	26	250
1	132,46 €	196,47 €	206,75 €	279,73 €	30	300
1	157,00 €	236,53 €	255,83 €	344,33 €	40	400

Monde Acero



U	Ø 19 REF K.8518A	Ø 30 REF K.8507A	Ø 19/19 REF K.8519A	Ø 30/19 REF K.8521A	Q	cm
1	99,29 €	144,03 €	159,80 €	210,52 €	16	150
1	108,88 €	159,18 €	178,99 €	235,27 €	20	200
1	141,27 €	205,83 €	224,37 €	297,90 €	26	250
1	150,26 €	221,26 €	242,35 €	322,32 €	30	300
1	174,80 €	261,33 €	291,43 €	386,93 €	40	400

Cavity Acero



U	Ø 19 REF K.8618	Ø 30 REF K.8607	Ø 19/19 REF K.8619	Ø 30/19 REF K.8621	Q	cm
1	96,83 €	135,72 €	154,88 €	199,76 €	16	150
1	107,59 €	151,04 €	176,41 €	225,84 €	20	200
1	140,14 €	195,29 €	222,11 €	286,24 €	26	250
1	150,31 €	210,89 €	242,44 €	312,00 €	30	300
1	176,18 €	248,72 €	294,19 €	375,71 €	40	400

Tapón Acero



U	Ø 19 REF K.6318	Ø 30 REF K.6307	Ø 19/19 REF K.6319	Ø 30/19 REF K.6321	Q	cm
1	78,48 €	111,21 €	118,17 €	156,88 €	16	150
1	89,24 €	126,52 €	139,70 €	182,97 €	20	200
1	121,79 €	170,78 €	185,40 €	243,36 €	26	250
1	131,95 €	186,37 €	205,74 €	269,12 €	30	300
1	157,83 €	224,20 €	257,49 €	332,83 €	40	400

Monde Acero

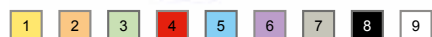
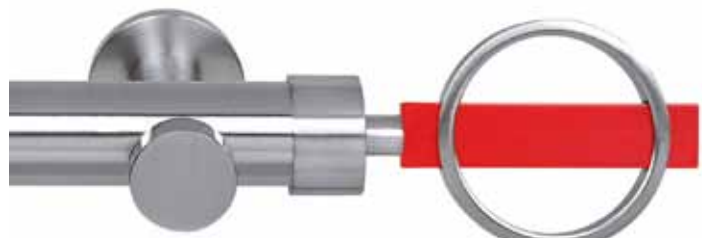

U	Ø 19 REF K.8518	Ø 30 REF K.8507	Ø 19/19 REF K.8519	Ø 30/19 REF K.8521	Q	cm
1	100,79 €	139,40 €	162,79 €	207,39 €	16	150
1	111,55 €	154,72 €	184,32 €	233,47 €	20	200
1	144,10 €	198,97 €	230,02 €	293,87 €	26	250
1	154,26 €	214,57 €	250,36 €	319,63 €	30	300
1	180,14 €	252,40 €	302,11 €	383,34 €	40	400

Barra de Cortina INFINITY VECTOR / Curtain Pole INFINITY VECTOR / Tringle a Rideau INFINITY VECTOR



Vector triangular color Acero



Vector cuadrado Naranja



Vector triangular Amarillo



Vector cuadrado Negro



Vector triangular Azul



Vector cuadrado Rojo



Vector triangular Blanco



Vector cuadrado Verde





Vector triangular Gris



Vector cuadrado Violeta

 Lo más innovador de esta colección reside en el soporte, cuya sofisticación introduce nuevos conceptos y estilos en el mercado. Sin duda una colección original que se complementa con la barra y el soporte en color acero y 10 acabados en diferentes colores, con complementos a juego, para dar múltiples opciones y decorar ambientes con un toque de color.

 The most innovative aspect of this collection is its support, whose sophistication introduces new concepts and styles for decoration. Definitely an original collection that complements itself with the steel finish support, poles and 10 different colours with matching accessories to give multiple options for room decoration with a touch of colour.

 L'aspect le plus novateur de cette collection réside dans les supports, que introduisent sophistication, de nouveaux concepts et de styles pour la décoration. Certainement une collection originale qui se complète avec la barre et les supports de finition en acier, et 10 couleurs différentes avec les accessoires assortis pour donner de multiples options pour la décoration de la chambre avec une touche de couleur.

INFINITY VECTOR

Conjuntos completos VECTOR /
Complete sets VECTOR /
Kits complete VECTOR

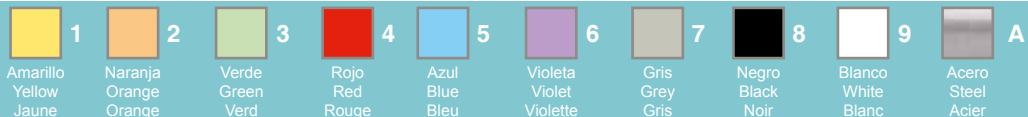

Triangular Acero



	Ø 19 REF K.8818A	Ø 30 REF K.8807A				
1	61,43 €	89,79 €			16	150
1	71,02 €	104,95 €			20	200
1	121,74 €	171,40 €			26	250
1	136,90 €	186,83 €			30	300
1	155,27 €	226,90 €			40	400

Triangular Colores



	Ø 19 REF K.8818	Ø 30 REF K.8807				
1	58,42 €	81,77 €			16	150
1	69,18 €	97,08 €			20	200
1	120,06 €	161,14 €			26	250
1	136,39 €	176,73 €			30	300
1	156,10 €	214,57 €			40	400

Cuadrado Acero



	Ø 19 REF K.8918A	Ø 30 REF K.8907A				
1	61,43 €	89,79 €			16	150
1	71,02 €	104,95 €			20	200
1	121,74 €	171,40 €			26	250
1	136,90 €	186,83 €			30	300
1	155,27 €	226,90 €			40	400

Cuadrado Colores



	Ø 19 REF K.8918	Ø 30 REF K.8907				
1	58,42 €	81,77 €			16	150
1	69,18 €	97,08 €			20	200
1	120,06 €	161,14 €			26	250
1	136,39 €	176,73 €			30	300
1	156,10 €	214,57 €			40	400

Barra de Cortina INFINITY CRISTAL / Curtain Pole INFINITY CRISTAL / Tringle a Rideux INFINITY CRISTAL



Tapón



Cilindro





Copa



Destello

 Infinity CRISTAL se apodera del estilismo y la pureza de un material noble como el cristal para dar un aire moderno y puro a cualquier estancia.

 Infinity CRISTAL seizes the styling and the purity of a noble material like glass to give a modern and pure air to any room.

 Infinity CRISTAL mélange le style et la pureté d'un matériau noble comme le verre pour donner un air moderne et pur à chaque décoration.

* Empaquetado en blister / Supplier in blister / Emballé en blister

∅ 19 / 30 mm

INFINITY CRISTAL

Conjuntos completos CRISTAL /
Complete sets CRISTAL /
Kits complete CRISTAL

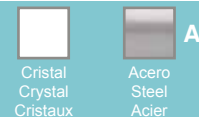

Tapón



	∅ 19 REF K.5118A	∅ 30 REF K.5107A	∅ 19/19 REF K.5119A	∅ 30/19 REF K.5121A		
1	88,80 €	130,69 €	138,83 €	186,69 €	16	150
1	98,39 €	145,84 €	158,01 €	211,44 €	20	200
1	130,78 €	192,49 €	203,39 €	274,07 €	26	250
1	139,77 €	207,92 €	221,38 €	298,49 €	30	300
1	164,31 €	247,99 €	270,46 €	363,10 €	40	400

Cilindro



	∅ 19 REF K.5218A	∅ 30 REF K.5207A	∅ 19/19 REF K.5219A	∅ 30/19 REF K.5221A		
1	101,87 €	143,98 €	164,96 €	213,05 €	16	150
1	111,46 €	159,14 €	184,14 €	237,80 €	20	200
1	143,84 €	205,78 €	229,52 €	300,43 €	26	250
1	152,84 €	221,21 €	247,50 €	324,85 €	30	300
1	177,38 €	261,28 €	296,59 €	389,46 €	40	400

Copa



	∅ 19 REF K.5318A	∅ 30 REF K.5307A	∅ 19/19 REF K.5319A	∅ 30/19 REF K.5321A		
1	95,75 €	139,70 €	152,72 €	202,65 €	16	150
1	105,34 €	154,86 €	171,90 €	227,40 €	20	200
1	137,72 €	201,50 €	217,28 €	290,03 €	26	250
1	146,72 €	216,94 €	235,27 €	314,46 €	30	300
1	171,26 €	257,00 €	284,35 €	379,06 €	40	400

Destello



	∅ 19 REF K.5418A	∅ 30 REF K.5407A	∅ 19/19 REF K.5419A	∅ 30/19 REF K.5421A		
1	93,45 €	134,32 €	148,12 €	194,97 €	16	150
1	103,04 €	149,48 €	167,30 €	219,72 €	20	200
1	135,42 €	196,12 €	212,68 €	282,35 €	26	250
1	144,42 €	211,55 €	230,67 €	306,77 €	30	300
1	168,96 €	251,62 €	279,75 €	371,38 €	40	400

Barra de Cortina INFINITY ICE / Curtain Pole INFINITY ICE / Tringle a Rideux INFINITY ICE



(*) Lyra



Astra (*)



(*) Indus



Oslo (*)



(*) Custom



Ejemplo Custom /
Example Custom / Exemple Custom





Ejemplo Custom /
Example Custom / Exemple Custom



Ejemplo Custom /
Example Custom / Exemple Custom

 Infinity ICE permite customizar algunos de sus elementos de una forma que ninguna otra colección permite gracias al uso de recipientes transparentes de metacrilato.

 Infinity ICE allows customize some elements in a way that no other collection through the use of transparent acrylic finials.

 Infinity ICE permet de personnaliser certains éléments d'une manière qu'aucun autre collection grâce à l'utilisation des embouts acryliques transparents.

* Empaquetado en blister / Supplier in blister / Emballé en blister

Ø 19 / 30 mm

INFINITY ICE

Conjuntos completos ICE /
Complete sets ICE /
Kits complete ICE

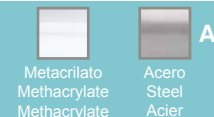

Lyra



U	Ø 19 REF K.17118A	Ø 30 REF K.17107A	Ø 19/19 REF K.17119A	Ø 30/19 REF K.17121A	Q	cm
1	106,38 €	152,12 €	173,97 €	225,70 €	16	150
1	115,97 €	167,28 €	193,15 €	250,45 €	20	200
1	148,35 €	213,92 €	238,53 €	313,08 €	26	250
1	157,34 €	229,36 €	256,52 €	337,50 €	30	300

Astra



U	Ø 19 REF K.17218A	Ø 30 REF K.17207A	Ø 19/19 REF K.17219A	Ø 30/19 REF K.17221A	Q	cm
1	106,74 €	157,41 €	174,71 €	231,36 €	16	150
1	116,33 €	172,57 €	193,89 €	256,11 €	20	200
1	148,72 €	219,21 €	239,27 €	318,73 €	26	250
1	157,71 €	234,65 €	257,26 €	343,16 €	30	300

Indus



U	Ø 19 REF K.17318A	Ø 30 REF K.17307A	Ø 19/19 REF K.17319A	Ø 30/19 REF K.17321A	Q	cm
1	109,14 €	132,20 €	179,49 €	233,20 €	16	150
1	118,73 €	172,02 €	198,67 €	257,95 €	20	200
1	151,11 €	218,66 €	244,05 €	320,57 €	26	250
1	160,10 €	234,09 €	262,04 €	345,00 €	30	300

Oslo



U	Ø 19 REF K.17418A	Ø 30 REF K.17407A	Ø 19/19 REF K.17419A	Ø 30/19 REF K.17421A	Q	cm
1	111,62 €	155,80 €	184,46 €	234,62 €	16	150
1	121,21 €	170,96 €	203,64 €	259,37 €	20	200
1	153,59 €	217,60 €	249,02 €	322,00 €	26	250
1	162,59 €	233,04 €	267,01 €	346,43 €	30	300

Custom



U	Ø 30 REF K.17507A	Q	cm
1	140,71 €	16	150
1	155,87 €	20	200
1	202,52 €	26	250
1	217,95 €	30	300

Barra de Cortina INFINITY POLAR / Curtain Pole INFINITY POLAR / Tringle a Rideux INFINITY POLAR

Metacrilato ■
Methacrylate
Methacrylate

■ Acero
Steel
Acier



Austral



Austral

Conjuntos completos POLAR Acero /
Complete sets POLAR Acero /
Kits complete POLAR Acero



Austral



U	Ø 30 REF K.12307T	Ø 30/19 REF K.12321T	cm
1	136,90 □	185,59 € *	150
1	152,05 □	210,34 € *	200
1	198,70 □	272,96 € *	250
1	214,13 □	297,39 € *	300

ES (*) Conjunto dobles POLAR Acero:
La Barra 19mm se sirve con piña tapón.

GB (*) Double sets POLAR Acero:
Pole of 19 mm with finial endcap.

FR (*) Kits doubles POLAR Acero:
Barre de 19 mm avec embout bouchon.

Conjuntos completos POLAR Metacrilato /
Complete sets POLAR Methacrylate /
Kits complete POLAR Methacrylate

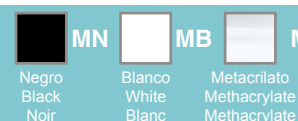

Austral



U	Ø 30 REF K.12007T	cm
1	191,04 €	150
1	218,57 €	200
1	271,33 €	300

ES Infinity POLAR es una colección realmente atractiva que permite personalizar la barra en acero o en metacrilato.

GB Infinity POLAR is a really attractive collection that allows you to customize the decoration using the steel or acrylic poles.

FR Infinity POLAR est une collection vraiment intéressante qui vous permet de personnaliser la décoration en utilisant les barres d'acier ou acryliques.

Ø 19 / 30 mm



Romántica

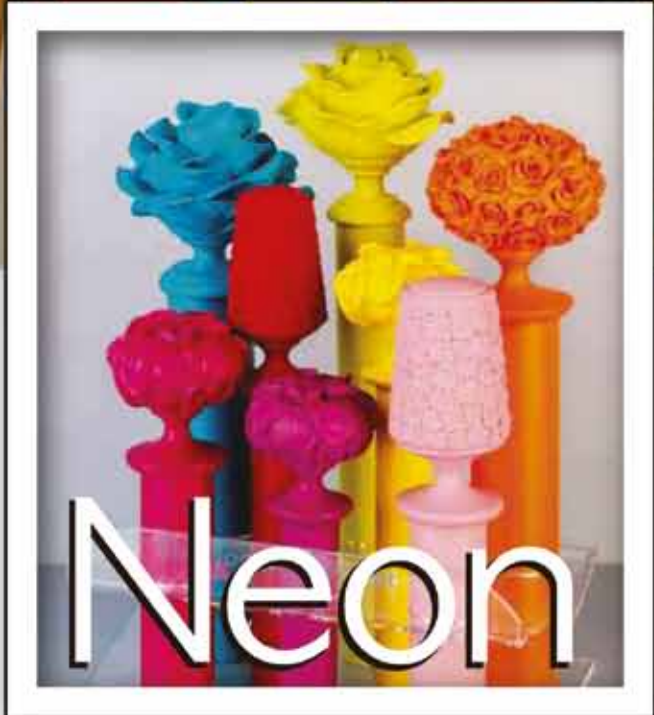

Neon

Serie
Prestige



Barra de Cortina INFINITY VANITY / Curtain Pole INFINITY VANITY / Tringle a Rideux INFINITY VANITY

- Diseñado con cristales originales de Swarovski®
 Designed with original crystals from Swarovski®
 Conçue avec cristaux originaux Swarovski®



Aura



Orbe



Estela

Altran ha diseñado su colección de acero inoxidable Infinity Vanity empleando exclusivos cristales from Swarovski®. Pocos complementos tan lujosos y elegantes como el cristal tallado se ven en el mercado de las barras de cortina y mucho menos si ese cristal cuenta con el aval y el esmero con el que Swarovski trabaja cada una de sus piezas. Disfrute de un mundo privilegiado con esta colección.

Altran has designed his collection of stainless steel Infinity Vanity using exclusive crystals from Swarovski®. Very few so luxurious and elegant complements like the carved crystal are seen on the market of the curtain poles and much less if this crystal relies on the support and the credentials of every single Swarovski piece. Enjoy a privileged world with this collection.

Altran a conçu la collection d'acier inoxydable Infinity Vanity en utilisant des cristaux from Swarovski®. Très peu de compléments si luxueux et élégants comme le cristal sculpté sont disponibles sur le marché des tringles à rideaux et beaucoup moins si ce cristal repose sur le soutien et l'accréditation de chaque pièce unique Swarovski. Profitez d'un monde privilégié avec cette collection.

INFINITY VANITY

Conjuntos completos VANITY Cristales de Swarovski® /
Complete sets VANITY Crystals from Swarovski® /
Kits complete VANITY Cristaux Swarovski®

Cristal
Crystal
Cristaux

Acero
Steel
Acier

Aura



	Ø 19 REF K.14618A	Ø 30 REF K.14607A	Ø 19/19 REF K.14619A	Ø 30/19 REF K.14621A		cm
1	152,52 €	210,79 €	266,27 €	330,51 €	16	150
1	162,11 €	225,94 €	285,45 €	355,26 €	20	200
1	194,50 €	272,59 €	330,83 €	417,89 €	26	250
1	203,49 €	288,02 €	348,82 €	442,31 €	30	300

Orbe



	Ø 19 REF K.14818A	Ø 30 REF K.14807A	Ø 19/19 REF K.14819A	Ø 30/19 REF K.14821A		cm
1	184,48 €	395,91 €	330,19 €	547,59 €	16	150
1	194,07 €	411,06 €	349,37 €	572,34 €	20	200
1	226,46 €	457,71 €	394,75 €	634,97 €	26	250
1	235,45 €	473,14 €	412,74 €	659,39 €	30	300

Estela



	Ø 19 REF K.14918A	Ø 30 REF K.14907A	Ø 19/19 REF K.14919A	Ø 30/19 REF K.14921A		cm
1	170,28 €	222,83 €	301,79 €	360,31 €	16	150
1	179,87 €	237,98 €	320,97 €	385,06 €	20	200
1	212,26 €	284,63 €	366,35 €	447,69 €	26	250
1	221,25 €	300,06 €	384,34 €	472,11 €	30	300

Certificado de Calidad Disponible.
Certificate of Quality Available.
Certificat de Qualité Disponible.

Estos terminales de cortina brillan por encima de todo porque están creados con Crystals from Swarovski®.

This finials have a special unique GLOW since they are developed with Crystals from Swarovski®.

Ces embouts ont un éclat brillant unique parce qu'ils ont été développés avec Crystals from Swarovski®.

Barra de Cortina INFINITY BASIC / Curtain Pole INFINITY BASIC / Tringle a Rideux INFINITY BASIC



(*) Multipiña



(*) Calada



(*) Cenefa



(*) Metro



(*) Tapón



(*) Creta acero





(*) Rodas acero



(*) Media Bola

 Infinity BASIC abarca un mercado más sencillo ofreciendo una opción muy económica pero rica en una estética moderna gracias a sus perfectos acabados en acero.

 Infinity BASIC aims to provide solutions for those decorations where its needed an economical option but with a modern design with its perfect steel finish.

 Infinity BASIC offre des solutions pour les décorations où il y a besoin d'une option économique mais avec un design moderne avec sa finition en acier.

* Empaquetado en blister / Supplier in blister / Emballé en blister

Ø 19 / 30 mm

INFINITY BASIC

Conjuntos completos BASIC /
Complete sets BASIC /
Kits complete BASIC



Multiplaña



	Ø 19 REF K.6018A	Ø 30 REF K.6007A	Ø 19/19 REF K.6019A	Ø 30/19 REF K.6021A		cm
1	88,11 €	135,88 €	137,45 €	191,20 €	16	150
1	97,70 €	151,04 €	156,63 €	215,95 €	20	200
1	130,09 €	197,69 €	202,01 €	278,58 €	26	250
1	139,08 €	213,12 €	220,00 €	303,00 €	30	300
1	163,62 €	253,18 €	269,08 €	367,61 €	40	400

Calada



	Ø 19 REF K.6118A	Ø 30 REF K.6107A	Ø 19/19 REF K.6119A	Ø 30/19 REF K.6121A		cm
1	85,58 €	131,65 €	132,39 €	184,44 €	16	150
1	95,17 €	146,81 €	151,57 €	209,19 €	20	200
1	127,56 €	193,45 €	196,95 €	271,81 €	26	250
1	136,55 €	208,89 €	240,79 €	296,24 €	30	300
1	174,02 €	248,95 €	289,87 €	360,85 €	40	400

Cenefa



	Ø 19 REF K.6218A	Ø 30 REF K.6207A	Ø 19/19 REF K.6219A	Ø 30/19 REF K.6221A		cm
1	86,09 €	135,06 €	133,40 €	188,35 €	16	150
1	95,68 €	150,21 €	152,58 €	213,10 €	20	200
1	128,06 €	196,86 €	197,96 €	275,72 €	26	250
1	137,06 €	212,29 €	215,95 €	300,15 €	30	300
1	161,60 €	252,36 €	265,03 €	364,76 €	40	400

Metro



	Ø 19 REF K.8018A	Ø 30 REF K.8007A	Ø 19/19 REF K.8019A	Ø 30/19 REF K.8021A		cm
1	88,48 €	128,85 €	138,18 €	184,53 €	16	150
1	98,07 €	144,00 €	157,37 €	209,28 €	20	200
1	130,46 €	190,65 €	202,75 €	271,91 €	26	250
1	139,45 €	206,08 €	220,73 €	296,33 €	30	300
1	163,99 €	246,15 €	269,81 €	360,94 €	40	400

Conjuntos completos BASIC /
Complete sets BASIC /
Kits complete BASIC



Tapón



U	Ø 19 REF K.6318A	Ø 30 REF K.6307A	Ø 19/19 REF K.6319A	Ø 30/19 REF K.6321A	Q	cm
1	81,49 €	119,23 €	124,20 €	167,92 €	16	150
1	91,08 €	134,69 €	143,38 €	192,67 €	20	200
1	123,46 €	181,03 €	188,76 €	255,30 €	26	250
1	132,46 €	196,47 €	206,75 €	279,73 €	30	300
1	157,00 €	236,53 €	255,83 €	344,33 €	40	400

Creta



U	Ø 19 REF K.11318A	Ø 30 REF K.11307A	Ø 19/19 REF K.11319A	Ø 30/19 REF K.11321A	Q	cm
1	98,65 €	151,52 €	158,52 €	217,37 €	16	150
1	108,24 €	166,68 €	177,70 €	242,12 €	20	200
1	165,26 €	213,33 €	223,08 €	304,75 €	26	250
1	149,62 €	228,76 €	241,06 €	329,18 €	30	300
1	174,16 €	231,15 €	290,15 €	393,78 €	40	400

Rodas



U	Ø 19 REF K.11518A	Ø 30 REF K.11507A	Ø 19/19 REF K.11519A	Ø 30/19 REF K.11521A	Q	cm
1	97,31 €	150,28 €	140,99 €	214,80 €	16	150
1	106,90 €	165,44 €	175,03 €	239,55 €	20	200
1	139,29 €	212,08 €	220,41 €	302,17 €	26	250
1	148,28 €	227,52 €	238,40 €	326,60 €	30	300
1	172,82 €	267,58 €	287,48 €	391,21 €	40	400

Media Bola



U	Ø 19 REF K.12418A	Ø 30 REF K.12407A	Ø 19/19 REF K.12419A	Ø 30/19 REF K.12421A	Q	cm
1	90,74 €	148,72 €	142,69 €	206,66 €	16	150
1	100,33 €	163,88 €	161,87 €	231,40 €	20	200
1	132,71 €	210,52 €	207,25 €	294,03 €	26	250
1	141,70 €	225,95 €	225,24 €	318,46 €	30	300
1	166,24 €	266,02 €	274,32 €	383,07 €	40	400



Aqua acero



Eolo acero



Iris acero



Blasón acero y negro



Olimpo acero y negro



Atlas acero

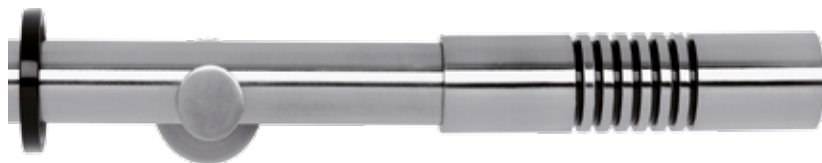

Etna acero y negro



Etna acero



Vega acero y negro





Vega acero



Solaris acero

 Infinity EXCLUSIVE busca diferenciarse del resto mostrando orgullosamente un estilo propio, arriesgado y moderno.

 EXCLUSIVE Infinity seeks to differentiate itself from the rest displaying its own particular and modern style.

 Infinity EXCLUSIVE cherche à se différencier du reste avec son propre style et modernité.

Ø 19 / 30 mm

Conjuntos completos EXCLUSIVE /
Complete sets EXCLUSIVE /
Kits complete EXCLUSIVE



Aqua Acero



U	Ø 19 REF K.6418A	Ø 30 REF K.6407A	Ø 19/19 REF K.6419A	Ø 30/19 REF K.6421A	cm	cm
1	113,41 €	149,32 €	188,05 €	229,93 €	16	150
1	123,00 €	164,47 €	207,23 €	254,68 €	20	200
1	155,39 €	211,12 €	252,61 €	317,31 €	26	250
1	164,38 €	226,55 €	270,60 €	341,73 €	30	300
1	188,92 €	266,62 €	319,68 €	406,34 €	40	400

Eolo Acero

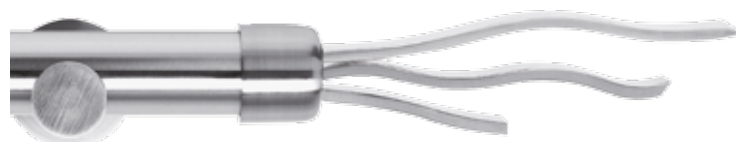

U	Ø 19 REF K.6518A	Ø 30 REF K.6507A	Ø 19/19 REF K.6519A	Ø 30/19 REF K.6521A	cm	cm
1	127,81 €	162,20 €	216,84 €	257,21 €	16	150
1	137,40 €	177,35 €	236,03 €	281,96 €	20	200
1	169,79 €	224,00 €	281,41 €	344,59 €	26	250
1	178,78 €	239,43 €	299,39 €	369,01 €	30	300
1	203,32 €	279,50 €	348,47 €	433,62 €	40	400

Iris Acero



U	Ø 19 REF K.6618A	Ø 30 REF K.6607A	Ø 19/19 REF K.6619A	Ø 30/19 REF K.6621A	cm	cm
1	109,46 €	144,30 €	180,14 €	220,96 €	16	150
1	119,05 €	159,46 €	199,32 €	245,71 €	20	200
1	151,43 €	206,10 €	244,70 €	308,34 €	26	250
1	160,43 €	221,54 €	262,68 €	332,76 €	30	300
1	184,97 €	261,60 €	311,77 €	397,37 €	40	400

Blasón Acero y Negro



U	Ø 19 REF K.5918AB	Ø 30 REF K.5907AB	Ø 19/19 REF K.5919AB	Ø 30/19 REF K.5921AB	cm	cm
1	103,34 €	167,67 €	167,90 €	238,21 €	16	150
1	112,93 €	182,83 €	187,08 €	262,96 €	20	200
1	145,31 €	229,47 €	232,46 €	325,59 €	26	250
1	154,31 €	244,90 €	250,45 €	350,01 €	30	300
1	178,85 €	284,97 €	299,53 €	414,62 €	40	400

Olimpo Acero y Negro



U	Ø 19 REF K.5818A	Ø 30 REF K.5807A	Ø 19/19 REF K.5819A	Ø 30/19 REF K.5821A	cm	cm
1	102,19 €	151,62 €	165,60 €	221,01 €	16	150
1	111,78 €	166,77 €	184,78 €	245,76 €	20	200
1	144,16 €	213,42 €	230,16 €	308,38 €	26	250
1	153,16 €	228,85 €	248,15 €	332,81 €	30	300
1	177,70 €	268,92 €	297,23 €	397,42 €	40	400

Atlas Acero



U	Ø 19 REF K.6718A	Ø 30 REF K.6707A	Ø 19/19 REF K.6719A	Ø 30/19 REF K.6721A	cm	cm
1	95,66 €	151,39 €	152,54 €	214,25 €	16	150
1	105,25 €	166,54 €	171,72 €	238,99 €	20	200
1	137,63 €	213,19 €	217,10 €	301,62 €	26	250
1	146,63 €	228,62 €	235,08 €	326,05 €	30	300
1	171,17 €	268,69 €	284,17 €	390,66 €	40	400

INFINITY EXCLUSIVE

Conjuntos completos EXCLUSIVE /
Complete sets EXCLUSIVE /
Kits complete EXCLUSIVE



Etna Acero



U	Ø 19 REF K.6918A	Ø 30 REF K.6907A	Ø 19/19 REF K.6919A	Ø 30/19 REF K.6921A	Q	cm
1	102,97 €	174,02 €	167,16 €	244,19 €	16	150
1	112,56 €	189,18 €	186,35 €	268,94 €	20	200
1	144,95 €	235,82 €	231,73 €	331,57 €	26	250
1	153,94 €	251,25 €	249,71 €	355,99 €	30	300
1	178,48 €	291,32 €	298,79 €	420,60 €	40	400

Etna Acero y Negro



U	Ø 19 REF K.6918AB	Ø 30 REF K.6907AB	Ø 19/19 REF K.6919AB	Ø 30/19 REF K.6921AB	Q	cm
1	101,22 €	178,20 €	163,67 €	246,63 €	16	150
1	110,81 €	193,36 €	182,85 €	271,38 €	20	200
1	143,20 €	240,01 €	228,23 €	334,01 €	26	250
1	152,19 €	255,44 €	246,22 €	358,43 €	30	300
1	176,73 €	295,50 €	295,30 €	423,04 €	40	400

Vega Acero



U	Ø 19 REF K.7018A	Ø 30 REF K.7007A	Ø 19/19 REF K.7019A	Ø 30/19 REF K.7021A	Q	cm
1	121,10 €	166,80 €	203,41 €	255,09 €	16	150
1	130,69 €	181,95 €	222,59 €	279,84 €	20	200
1	155,78 €	222,59 €	267,97 €	342,47 €	26	250
1	172,06 €	244,03 €	285,96 €	366,90 €	30	300
1	196,60 €	284,10 €	335,04 €	431,50 €	40	400

Vega Acero y Negro





U	Ø 19 REF K.7018AB	Ø 30 REF K.7007AB	Ø 19/19 REF K.7019AB	Ø 30/19 REF K.7021AB	Q	cm
1	122,66 €	186,53 €	206,54 €	276,39 €	16	150
1	132,25 €	201,69 €	225,72 €	301,14 €	20	200
1	164,63 €	242,33 €	271,10 €	363,77 €	26	250
1	173,63 €	263,76 €	289,09 €	388,19 €	30	300
1	198,17 €	303,83 €	338,17 €	452,80 €	40	400



Solaris Acero





U	Ø 19 REF K.6818A	Ø 30 REF K.6807A	Ø 19/19 REF K.6819A	Ø 30/19 REF K.6821A	Q	cm
1	111,90 €	149,13 €	185,01 €	228,23 €	16	150
1	121,49 €	164,29 €	204,19 €	252,98 €	20	200
1	153,87 €	204,93 €	249,57 €	315,61 €	26	250
1	162,86 €	226,37 €	267,56 €	340,03 €	30	300
1	187,40 €	266,43 €	316,64 €	404,64 €	40	400

Información General INFINITY / INFINITY General Information / Informations Générales INIFNITY

 Los conjuntos de medida superior a 2 m se sirven con 3 soportes.
 Los conjuntos de más de 3 metros se sirven empalmados.
 Conjuntos Sencillos: 2 terminales, 2 soportes, barra y anillas de acero.
 Conjuntos Dobles*: 4 term., 2 sop.dobles, 2 barras y anillas.
 Conjunto dobles: Se sirven con el terminal TAPÓN en la barra trasera.

 All sets with a length longer than 2 meters are supplied with 3 brackets.
 Sets of more than 3 mts. are supplied in 2 halves and splice.
 Single sets: 2 finials, 2 brackets, pole & steel rings.
 Double sets*: 4 finials, 2 double brackets, 2 poles & steel rings.

 Tous les kits de mesures supérieures à 2 mètres contiennent 3 supports.
 Les sets de plus de 3 mts. sont fournis en 2 morceaux avec raccord.
 Kits Simples: 2 embouts, 2 supports, tube et anneaux acier.
 Kits Doubles*: 4 embouts, 2 supports doubles, 2 tubes et anneaux acier.

Expositores INFINITY / INFINITY Displays / Presentoirs INIFNITY

Expositor
Infinity ZEN

Infinity ZEN
Display Board /
Presentoir
Infinity ZEN



REF	∅	U	€	€	cm
M.212		1		87,72 €	

Expositor
Infinity COLORS

Infinity COLORS
Display Board /
Presentoir
Infinity COLORS

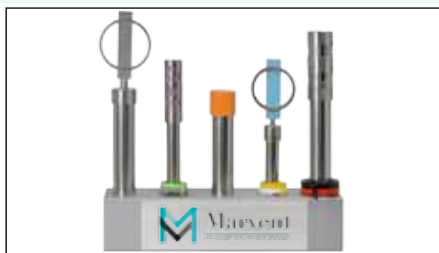

REF	∅	U	€	€	cm
M.211		1		44,20 €	

Expositor
Infinity CRISTAL

Infinity CRISTAL
Display Board /
Presentoir
Infinity CRISTAL



REF	∅	U	€	€	cm
M.213		1		65,28 €	

Expositor
Infinity ICE

Infinity ICE
Display Board /
Presentoir
Infinity ICE



REF	∅	U	€	€	cm
M.202		1		97,92 €	

Expositor
Infinity POLAR

Infinity POLAR
Display Board /
Presentoir
Infinity POLAR



REF	∅	U	€	€	cm
M.3006		1		68,10 €	

Expositores INFINITY / INFINITY Displays / Presentoirs INIFNITY

Expositor
Infinity VANITY
cristales originales de
Swarovski®

Infinity VANITY
Display Board /
Presentoir
Infinity VANITY



REF	∅				
M.205		1	308,04 €		

Expositor
Infinity BASIC

Infinity BASIC
Display Board /
Presentoir
Infinity BASIC



REF	∅				
M.203		1	112,00 €		

Terminales / Finials / Embouts ZEN



Trazos

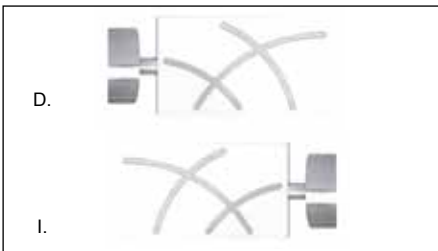

REF	∅				
01375-2119D	19	10	18,44€	21,21 €	
01375-2119I	19	10	18,44 €	21,21 €	
01376-2130D	30	10	21,02 €	24,17 €	
01376-2130I	30	10	21,02 €	24,17 €	

Ángulo Blanco

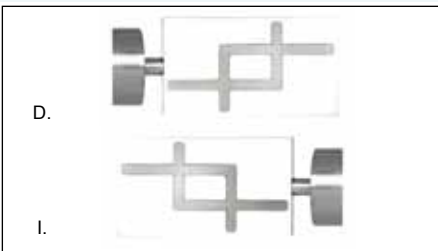

REF	∅				
01375-2219D	19	10	18,44€	21,21 €	
01375-2219I	19	10	18,44 €	21,21 €	
01376-2230D	30	10	21,02 €	24,17 €	
01376-2230I	30	10	21,02 €	24,17 €	

Ángulo Negro

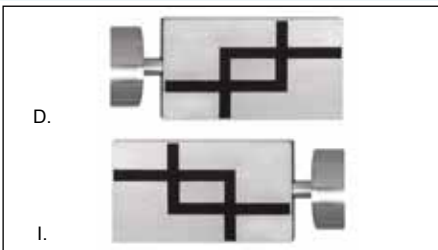

REF	∅				
01375-2319D	19	10	18,44€	21,21 €	
01375-2319I	19	10	18,44 €	21,21 €	
01376-2330D	30	10	21,02 €	24,17 €	
01376-2330I	30	10	21,02 €	24,17 €	

Olas

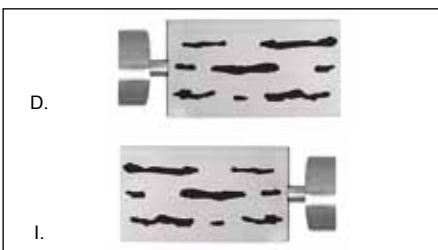

REF	∅				
01375-2419D	19	10	19,34 €	22,24 €	
01375-2419I	19	10	19,34 €	22,24 €	
01376-2430D	30	10	21,92 €	25,21 €	
01376-2430I	30	10	21,92 €	25,21 €	

Terminales / Finials / Embouts **COLORS**



Cavity Acero



REF	∅	U	€	€	cm
01375-A02019	19	10	9,64 €	11,09 €	
01376-A02030	30	10	14,80 €	17,02 €	

A

Cavity Colors



REF	∅	U	€	€	cm
01375-02019C	19	10	9,64 €	11,09 €	
01376-02030C	30	10	14,80 €	17,02 €	

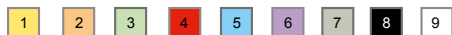

Tapón Acero



REF	∅	U	€	€	cm
01374-P6119	19	10	3,62 €	4,16 €	
01377-P6130	30	10	5,62 €	6,46 €	

A

Tapón Colors



REF	∅	U	€	€	cm
01375-6119C	19	10	1,66 €	1,91 €	
01376-6130C	30	10	4,14 €	4,76 €	

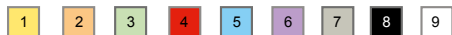

Monde Acero



REF	∅	U	€	€	cm
01375-A02119	19	10	11,36 €	13,06 €	
01376-A02130	30	10	16,40 €	18,86 €	

A

Monde Colors

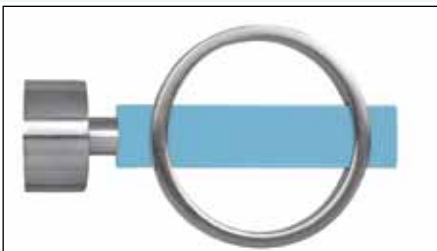

REF	∅	U	€	€	cm
01375-02119C	19	10	11,36 €	13,06 €	
01376-02130C	30	10	16,40 €	18,86 €	



Terminales / Finials / Embouts **CRISTAL**



Tapón



REF	∅	U	€	€	cm
01375-A6719	19	10	6,80 €	7,82 €	
01376-A6730	30	10	10,60 €	12,19 €	

Terminales / Finials / Embouts CRISTAL



A

Copa



REF	∅				
01375-A6819	19	10	9,82 €	11,29 €	
01376-A6830	30	10	14,52 €	16,70 €	

Cilindro



REF	∅				
01375-A6919	19	10	12,48 €	14,35 €	
01376-A6930	30	10	16,38 €	18,84 €	

Destello

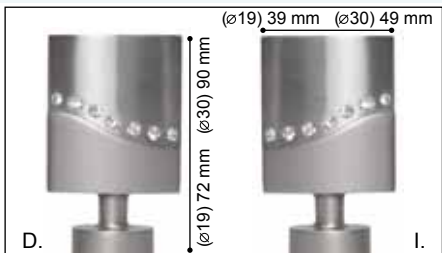

REF	∅				
01375-A6519D	19	10	8,82 €	10,14 €	
01375-A6519I	19	10	8,82 €	10,14 €	
01376-A6530D	30	10	12,18 €	14,01 €	
01376-A6530I	30	10	12,18 €	14,01 €	

Terminales / Finials / Embouts ICE



A

Astra



REF	∅				
01375-P3619	19	6	14,60 €	16,79 €	
01376-P3630	30	6	22,22 €	25,55 €	

Lyra



REF	∅				
01375-P3719	19	6	14,44 €	16,61 €	
01376-P3730	30	6	19,92 €	22,91 €	



REF	∅				
01375-P3819	19	6	16,72 €	19,23 €	
01376-P3830	30	6	21,52 €	24,75 €	

Indus



REF	∅				
01375-P3919	19	6	15,64 €	17,99 €	
01376-P3930	30	6	21,98 €	25,28 €	

Terminales / Finials / Embouts ICE



Custom

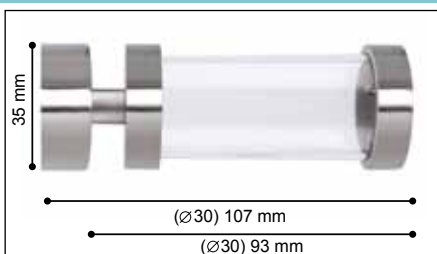

REF	∅	U	€	€	cm
01376-P9930	30	6	14,96 €	17,20 €	

Terminales / Finials / Embouts POLAR



Austral

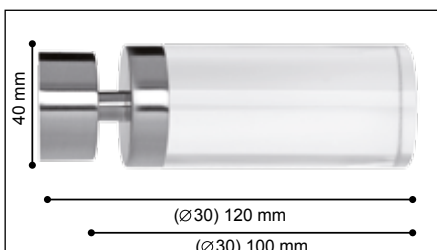

REF	∅	U	€	€	cm
01376-P8830	30	10	13,30 €	15,30 €	

Terminales / Finials / Embouts VANITY crystals from Swarovski®



Aura
con Cristales
Swarovski®



REF	∅	U	€	€	cm
01375-P9519	19	1		39,68 €	
01376-P9530	30	1		52,24 €	

Orbe
con Cristales
Swarovski®



REF	∅	U	€	€	cm
01375-P9719	19	1		55,66 €	
01376-P9730	30	1		144,80 €	

Estela
con Cristales
Swarovski®



REF	∅	U	€	€	cm
01375-P9819	19	1		48,56 €	
01376-P9830	30	1		58,26 €	

Terminales / Finials / Embouts BASIC



A

Multipiña



REF	∅				
01375-P6419	19	10	6,50 €	7,48 €	
01376-P6430	30	10	12,86 €	14,79 €	

Calada



REF	∅				
01375-P6219	19	10	5,40 €	6,21 €	
01376-P6230	30	10	11,02 €	12,67 €	

Cenefa



REF	∅				
01375-P6319	19	10	5,62 €	6,46 €	
01376-P6330	30	10	12,50 €	14,38 €	

Metro



REF	∅				
01375-P6719	19	10	6,66 €	7,66 €	
01376-P6730	30	10	9,80 €	11,27 €	

Tapón



REF	∅				
01374-P6119	19	10	3,62 €	4,16 €	
01377-P6130	30	10	5,62 €	6,46 €	

Creta

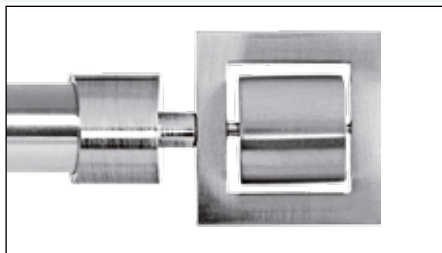

REF	∅				
01375-P7819	19	10	11,08 €	12,74 €	
01376-P7830	30	10	19,66 €	22,61 €	

Rodas



REF	∅				
01375-P8019	19	10	10,50 €	12,08 €	
01376-P8030	30	10	19,12 €	21,99 €	

Media Bola



REF	∅				
01375-P8919	19	10	7,64 €	8,79 €	
01376-P8930	30	10	18,44 €	21,21 €	

Aqua



REF	∅	U	€	€ ¹	cm
P.01219A1	19	10	17,50 €	20,13 €	
P.01230A1	30	10	18,70 €	21,51 €	

Eolo

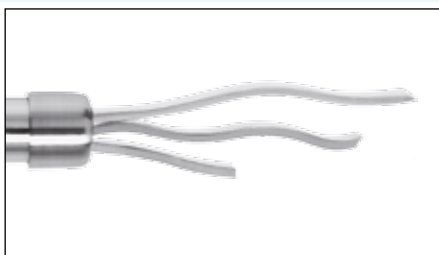

REF	∅	U	€	€ ¹	cm
P.01019A1	19	10	23,76 €	27,32 €	
P.01030A1	30	10	24,30 €	27,95 €	

Iris

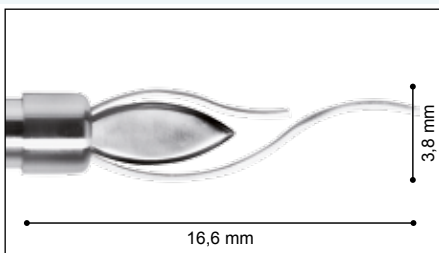

REF	∅	U	€	€ ¹	cm
P.00919A1	19	10	15,78 €	18,15 €	
P.00930A1	30	10	16,52 €	19,00 €	

Blasón

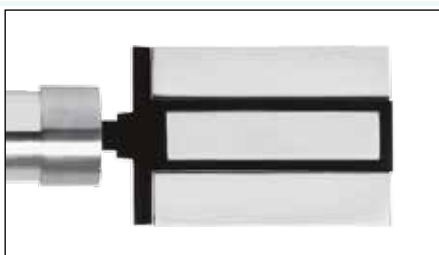

REF	∅	U	€	€ ¹	cm
P.01619AB1	19	10	13,12 €	15,09 €	
P.01630AB1	30	10	26,68 €	30,68 €	

Olimpo

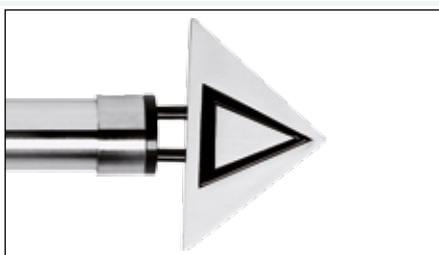

REF	∅	U	€	€ ¹	cm
P.01519AB1	19	10	12,62 €	14,51 €	
P.01530AB1	30	10	19,70 €	22,66 €	

Atlas



REF	∅	U	€	€ ¹	cm
P.00019A1	19	10	9,78 €	11,25 €	
P.00030A1	30	10	19,60 €	22,54 €	

Etna

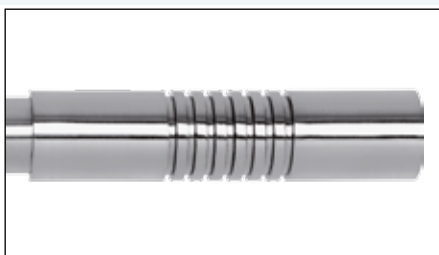

REF	∅	U	€	€ ¹	cm
P.00119A1	19	10	12,96 €	14,90 €	
P.00130A1	30	10	29,44 €	33,86 €	
P.00119AB1	19	10	12,20 €	14,03 €	
P.00130AB1	30	10	31,26 €	35,95 €	

Vega



REF	∅	U	€	€ ¹	cm
P.00219A1	19	10	20,84 €	23,97 €	
P.00230A1	30	10	26,30 €	30,25 €	
P.00219AB1	19	10	21,52 €	24,75 €	
P.00230AB1	30	10	34,88 €	40,11 €	

Terminales / Finials / Embouts EXCLUSIVE



Solaris

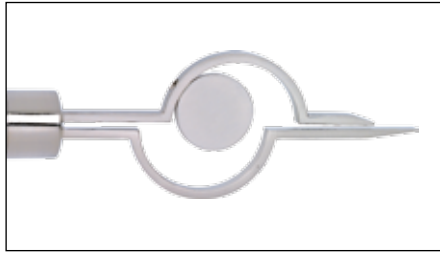

REF	∅				
P.00819A1	19	10	16,84 €	19,37 €	
P.00830A1	30	10	18,62 €	21,41 €	

Accesorios / Accessories / Accessoires

Soporte Corto

Short Wall Bracket / Support Court

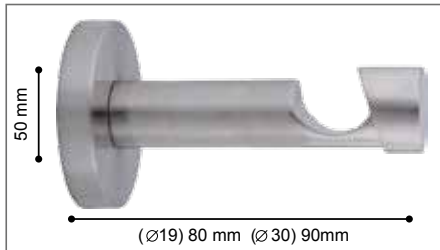

REF	∅				
01375-P20519	19	10	13,88 €	15,96 €	
01376-P20530	30	10	18,98 €	21,83 €	

Soporte Sencillo

Single Bracket / Support Mur

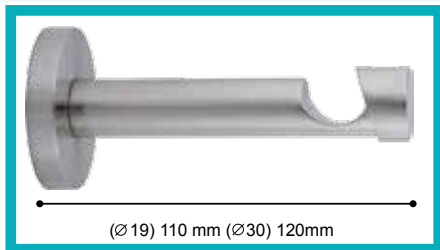

REF	∅				
01375-P20619	19	10	17,36 €	19,96 €	
01376-P20630	30	10	21,44 €	24,66 €	

* Soporte incluido en el Kit Sencillo /
Bracket supplied in the Single Kit / Support fourni dans le Simple Kit.

Soporte Doble

Double Wall Bracket / Support Mur Double

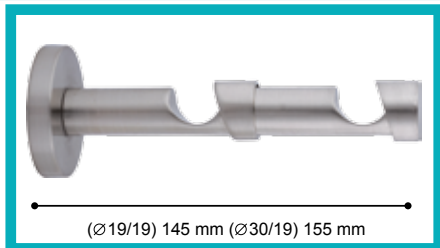

REF	∅				
01375-P23119	19/19	10	17,86 €	20,54 €	
01376-P23319	30/19	10	24,54 €	28,22 €	

* Soporte incluido en el Kit Doble /
Bracket supplied in the Double Kit / Support fourni dans le Double Kit.

Soporte Techo

Ceiling Bracket / Support Plafond



REF	∅				
01375-P20719	19	10	15,62 €	17,96 €	
01376-P20730	30	10	21,36 €	24,56 €	

Soporte Doble Techo

Double Ceiling Bracket / Support Plafond Double

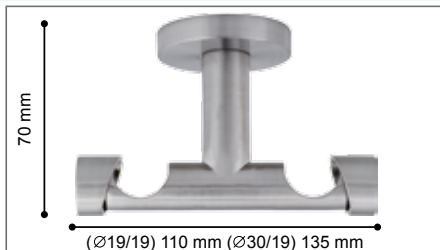

REF	∅				
01375-P24119	19/19	10	19,00 €	21,85 €	
01376-P24319	30/19	10	27,18 €	31,26 €	

Soporte Dintel

Recess Bracket / Entre-Murs



REF	∅				
01375-P20419	19	10	4,80 €	5,52 €	
01375-P20430	30	10	6,98 €	8,03 €	

* Nuevo Sistema que mejora la sujeción de la barra y su resistencia.
New system that improves the pole hold and resistance.
Nouveau système qui permet d'améliorer la fixation et résistance de la tringle.

NEW

Accesorios / Accessories / Accessoires

Soporte Triangular

Triangular bracket / Support en triangle



REF	∅	U	€	€	cm
01375-A8019	19	10	8,64 €	9,94 €	
01376-A8030	30	10	8,64 €	9,94 €	

* Soporte incluido en el Kit Sencillo Vector / Bracket supplied in the Vector Single Kit / Support fourni dans le Simple Kit Vector.

Soporte Cuadrado

Square bracket / Support en Carré



REF	∅	U	€	€	cm
01375-A9019	19	10	8,64 €	9,94 €	
01376-A9030	30	10	8,64 €	9,94 €	

* Soporte incluido en el Kit Sencillo Vector / Bracket supplied in the Vector Single Kit / Support fourni dans le Simple Kit Vector.

Prolongador

Extender / Prolongateur



REF	∅	U	€	€	cm
01375-P20819	19	10	4,28 €	4,92 €	
01376-P20830	30	10	8,34 €	9,59 €	

Codo Articulado

Elbow / Coude



REF	∅	U	€	€	cm
01374-PC	19	10	11,28 €	12,97 €	
01377-PC	30	10	16,96 €	19,50 €	

Empalme

Splice / Raccordeur

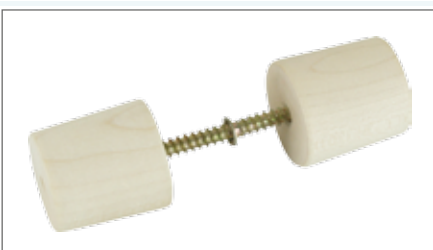

REF	∅	U	€	€	cm
02369-1517	19	10	2,72 €	3,13 €	
02368-1513	30	10	4,64 €	5,34 €	

Empalme Transparente

Transparent Splice / Raccordeur Transparent

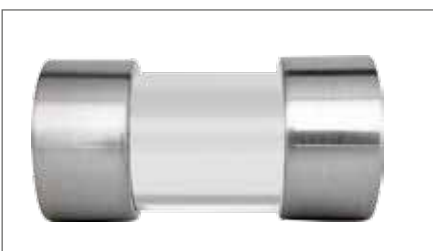

REF	∅	U	€	€	cm
H.07M	30	10	24,58 €	28,27 €	

Empalme Negro

Black Splice / Raccordeur Noir



REF	∅	U	€	€	cm
H.07MN	30	10	24,58 €	28,27 €	

Empalme Blanco

White Splice / Raccordeur Blanc



REF	∅	U	€	€	cm
H.07MB	30	10	24,58 €	28,27 €	

Accesorios / Accessories / Accessoires

Barra Acero

Steel Pole/
Tube Acier

REF	∅				
01374-P150	19	10	12,92 €	14,86 €	150
01374-P200	19	10	17,96 €	20,65 €	200
01374-P250	19	10	22,42 €	25,78 €	250
01374-P300	19	10	26,94 €	30,98 €	300
01377-P150	30	10	20,26 €	23,30 €	150
01377-P200	30	10	27,26 €	31,35 €	200
01377-P250	30	10	34,82 €	40,04 €	250
01377-P300	30	10	42,06 €	48,37 €	300

Barra Metacrilato

Methacrylate Pole /
Tube Méthacrilate

REF	∅				
01376-MTT150	30	10	45,90 €	52,79 €	150
01376-MTT200	30	10	63,66 €	73,21 €	200
01376-MTT250	30	10	84,58 €	97,27 €	250
01376-MTT300	30	10	91,80 €	105,57 €	300

Barra Metacrilato
NegroBlack
Methacrylate Pole /
Tube
Méthacrilate Noir

REF	∅				
01376-MTN150	30	10	45,90 €	52,79 €	150
01376-MTN200	30	10	63,66 €	73,21 €	200
01376-MTN250	30	10	84,58 €	97,27 €	250
01376-MTN300	30	10	91,80 €	105,57 €	300

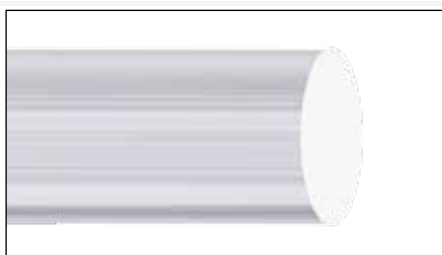
Barra Metacrilato
BlancoWhite
Methacrylate Pole /
Tube Méthacrilate
Blanc

REF	∅				
01376-MTB150	30	10	45,90 €	52,79 €	150
1376-MTB200	30	10	63,66 €	73,21 €	200
1376-MTB250	30	10	84,58 €	97,27 €	250
1376-MTB300	30	10	91,80 €	105,57 €	300

Tirador 1 metro
AceroCurtain steel
draw rod 1m. /
Lance rideau
acier 1m.

REF	∅				
01375-PTI	10	1		12,40 €	100

Tirador Metacrilato
1 metro con mango
15 mm1 m acrylic wand with
handle (15 mm) /
Tireur métacrylate 1 m
avec manche (15 mm)

REF	∅				
01375-TTI	15	1		17,70 €	100

Tirador Metacrilato
1 metro sin mango
15 mm1 m acrylic wand
without handle
(15 mm) /
Tireur métacrylate 1 m
sans manche (15 mm)

REF	∅				
01375-TTIE	15	1		11,40 €	100

NEW

Accesorios / Accessories / Accessoires

Anilla
(10 ud. blister)

Ring (10 pieces per blister) / Anneaux (10 pieces per blister)

(\varnothing 19) 37 mm (\varnothing 30) 52 mm
(\varnothing 19) 26 mm (\varnothing 30) 42 mm

REF	\varnothing	U	€	€	cm
01375-P20290	19	100	0,97 €	1,12 €	
01376-P20390	30	100	1,78 €	2,05 €	

Anillas
Rings / Anneaux

REF	\varnothing	U	€	€	cm
01375-20290C	19	100	1,08 €	1,24 €	
01376-20390C	30	100	1,58 €	1,82 €	

1 2 3 4 5 6 7 8 9

Anillas metacrilato
Acrylic Rings / Anneaux

(\varnothing 30) 56 mm.
(\varnothing 30) 40 mm.

REF	\varnothing	U	€	€	cm
S.21530M10	30	50	1,49 €	1,71 €	

Soporte Técnico Doble 19/19
Double Technical Bracket / Support Double Technique

80 mm. 185 mm.

REF	\varnothing	U	€	€	cm
01980-P41119	19/19	10	33,30 €	38,30 €	

Soporte Técnico Doble 30/19
Double Technical Bracket / Support double Technique

80 mm. 185 mm.

REF	\varnothing	U	€	€	cm
01980-P41319	30/19	10	38,66 €	44,46 €	

SOPORTES TÉCNICOS DOBLES / DOUBLE TECHNICAL BRACKET / SUPPORT TECHNIQUE DOUBLE

Soporte versátil capaz de adaptarse a cualquier tipo de instalación. / Versatile bracket of total reliability in any type of installation. / Support polyvalent et apte à s'adapter à tout type d'installation.

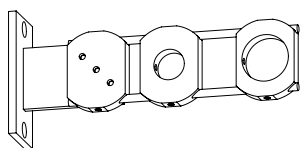

Soporte Técnico Pared Doble
Double technical wall bracket / Support technique mur double

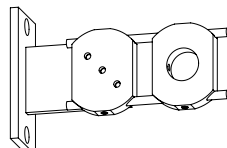

Soporte Pared
Wall bracket / Support mur

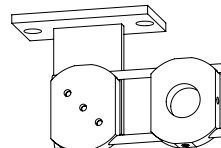

Soporte Techo
Ceiling bracket / Support plafond

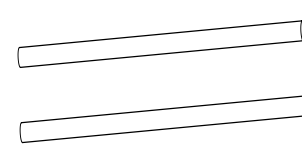

Varillas extra para Soporte Técnico Sencillo
Extra rods included to convert to single bracket / Tige supplémentaire pour support technique simple

Opción A / Option A

Opción B / Option B

Soporte Técnico de Techo Doble
Double technical ceiling bracket / Support technique plafond double

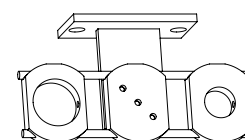
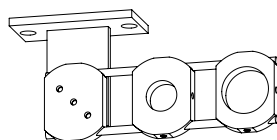

Abrazaderas Design / Designer Holdbacks / Embrasses Design

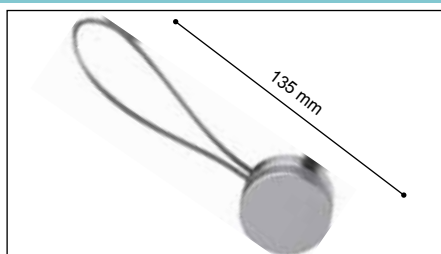

Anilla Abrazadera

Ring Holdback /
Anneau-Embrasse

REF	∅	U	€	€	cm
90361-P1542		10	11,44 €	13,16 €	

* Cada cara del magneto tiene un acabado diferente (acero y plata satinada), ofreciendo así 2 posibilidades en 1 sola pieza. / Each side of the Magneto has a different finish (steel & satin Nickel), thus offering 2 options with just one piece. / Chaque face a une finition différente (acier et Nickel satiné) offrant de fait 2 options sur une seule pièce.

Anilla Abrazadera

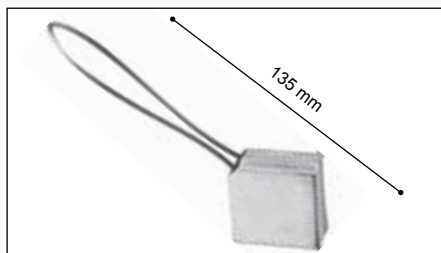
Ring Holdback /
Anneau-Embrasse

REF	∅	U	€	€	cm
90361-P1543		10	12,32 €	14,17 €	

* Cada cara del magneto tiene un acabado diferente (acero y plata satinada), ofreciendo así 2 posibilidades en 1 sola pieza. / Each side of the Magneto has a different finish (steel & satin Nickel), thus offering 2 options with just one piece. / Chaque face a une finition différente (acier et Nickel satiné) offrant de fait 2 options sur une seule pièce.

"S"

Anilla Abrazadera

Ring Holdback /
Anneau-Embrasse

REF	∅	U	€	€	cm
90336-A1518		10	15,44 €	17,76 €	
90336-CU1518		10	15,44 €	17,76 €	

Cuadrada

Anilla Abrazadera

Ring Holdback /
Anneau-Embrasse

REF	∅	U	€	€	cm
01336-A1519		10	13,56 €	15,59 €	
01336-CU1519		10	13,56 €	15,59 €	

Redonda

Anilla Abrazadera

Ring Holdback /
Anneau-Embrasse

REF	∅	U	€	€	cm
01336-A1521		10	14,20 €	16,33 €	
01336-CU1521		10	14,20 €	16,33 €	

Ovalada

Anilla Abrazadera

Ring Holdback /
Anneau-Embrasse

REF	∅	U	€	€	cm
01336-A1522		10	15,26 €	17,55 €	
01336-CU1522		10	15,26 €	17,55 €	

CORTINA VENECIANA
DE MADERA

Protección solar
creando zonas cálidas
y confortables,
embelleciendo el
ambiente y dándole
un toque personal a tu
casa.

Barra de Cortina CAVALLIER / Curtain Pole CAVALLIER / Tringle a Rideux CAVALLIER

■ Colección **Artisanal** fabricada Pieza a Pieza manualmente.
Handcrafted collection manufactured piece by piece.
 Création **Artisanal** produite pièce par pièce manuellement.



Cosmos Negro



Cosmos Blanco



Cosmos Oro



Cosmos Bronce



Cosmos Plata



Corona Altran con
Cristales Swarovski®



Corona Lisa



Corona Trono

■ Hemos querido renovar esta completa introduciendo nuevos terminales que se pueden combinar con colecciones como Infinity o Varadero debido a su acabado metálico en color Acero y Cuero. Cavallier se convierte en la colección más moderna del mercado debido a las formas de los terminales que dan vida a esta colección de altísima calidad.

■ We wanted to renew this collection by introducing new finials that can be combined with other collections such as Infinity or Varadero due to its metallic finish in Steel and Leather. The Cavallier collection becomes the most modern collection of the market due to their finial shapes that give a feeling to this top-quality collection.

■ Nous avons voulu renouveler cette collection en introduisant de nouvelles embouts qui peuvent être combinées avec d'autres collections comme Infinity ou Varadero en raison de sa finition métallique en acier et en cuir. La collection Cavallier devient la collection la plus moderne du marché en raison des formes de leurs embouts qui donnent un sentiment à cette collection de qualité supérieure.

Ø 19 / 30 mm

Barra de Cortina CAVALLIER / Curtain Pole CAVALLIER / Tringle a Rideux CAVALLIER



Cubis



Corneta Acero



Hoja

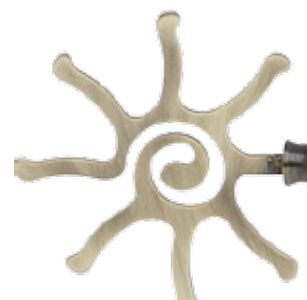
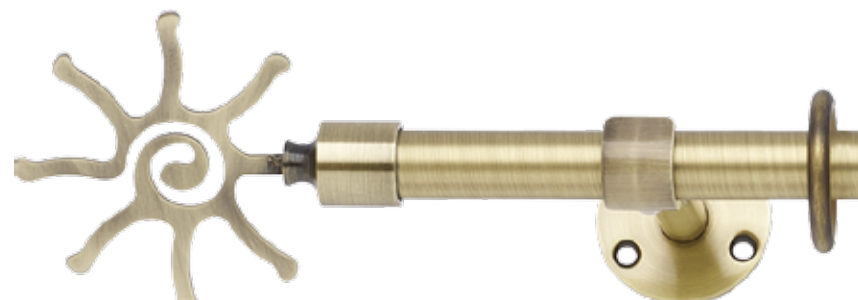

Sol Cuero



Púa



Terra Acero



Tapón Cuero



Espiral Cuero

Ø 19 / 30 mm

Conjuntos completos CAVALLIER /
Complete sets CAVALLIER /
Kits complete CAVALLIER

(**) Conjunto dobles: La Barra 19mm se sirve con piña tapón.
(**) Double sets: Pole of 19 mm with finial endcap.
(**) Kits doubles: Barre de 19 mm avec embout bouchon.

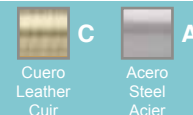

Cosmos Negro



U	Ø 19 REF K.2418_08	Ø 30 REF K.2407_08	Ø 19/19 (**) REF K.2419_08	Ø 30/19 (**) REF K.2421_08	cm	cm
1	108,63 €	145,43 €	153,87 €	196,10 €	16	150
1	117,90 €	156,79 €	172,41 €	208,68 €	20	200
1	143,31 €	189,89 €	212,24 €	254,89 €	26	250
1	151,98 €	201,53 €	229,59 €	275,20 €	30	300
1	*176,46 €	*234,49 €	*278,53 €	*332,63 €	40	400

Cosmos Blanco



U	Ø 19 REF K.2418_09	Ø 30 REF K.2407_09	Ø 19/19 (**) REF K.2419_09	Ø 30/19 (**) REF K.2421_09	cm	cm
1	108,63 €	145,43 €	153,87 €	196,10 €	16	150
1	117,90 €	156,79 €	172,41 €	208,68 €	20	200
1	143,31 €	189,89 €	212,24 €	254,89 €	26	250
1	151,98 €	201,53 €	229,59 €	275,20 €	30	300
1	*176,46 €	*234,49 €	*278,53 €	*332,63 €	40	400

Cosmos Oro



U	Ø 19 REF K.2418_10	Ø 30 REF K.2407_10	Ø 19/19 (**) REF K.2419_10	Ø 30/19 (**) REF K.2421_10	cm	cm
1	122,61 €	171,83 €	167,85 €	222,50 €	16	150
1	131,88 €	183,20 €	186,39 €	235,08 €	20	200
1	157,30 €	216,29 €	226,23 €	281,29 €	26	250
1	165,97 €	227,93 €	243,57 €	301,60 €	30	300
1	*190,44 €	*260,89 €	*292,51 €	*359,03 €	40	400

Cosmos Bronce



U	Ø 19 REF K.2418_11	Ø 30 REF K.2407_11	Ø 19/19 (**) REF K.2419_11	Ø 30/19 (**) REF K.2421_11	cm	cm
1	122,61 €	171,83 €	167,85 €	222,50 €	16	150
1	131,88 €	183,20 €	186,39 €	235,08 €	20	200
1	157,30 €	216,29 €	226,23 €	281,29 €	26	250
1	165,97 €	227,93 €	243,57 €	301,60 €	30	300
1	*190,44 €	*260,89 €	*292,51 €	*359,03 €	40	400

Cosmos Plata



U	Ø 19 REF K.2418_12	Ø 30 REF K.2407_12	Ø 19/19 (**) REF K.2419_12	Ø 30/19 (**) REF K.2421_12	cm	cm
1	122,61 €	171,83 €	167,85 €	222,50 €	16	150
1	131,88 €	183,20 €	186,39 €	235,08 €	20	200
1	157,30 €	216,29 €	226,23 €	281,29 €	26	250
1	165,97 €	227,93 €	243,57 €	301,60 €	30	300
1	*190,44 €	*260,89 €	*292,51 €	*359,03 €	40	400

Corona Altran con Cristales Swarovski®



U	Ø 19 REF K.27918	Ø 30 REF K.2707	Ø 19/19 (**) REF K.2719	Ø 30/19 (**) REF K.2721	cm	cm
1	112,03 €	139,86 €	157,27 €	190,53 €	16	150
1	121,30 €	151,23 €	175,81 €	203,11 €	20	200
1	146,72 €	184,32 €	215,65 €	249,32 €	26	250
1	155,39 €	195,96 €	232,99 €	269,63 €	30	300
1	*179,86 €	*298,92 €	*281,93 €	*327,06 €	40	400

CAVALLIER

Conjuntos completos CAVALLIER /
Complete sets CAVALLIER /
Kits complete CAVALLIER

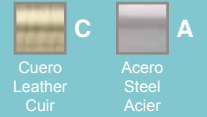

Corona Lisa



U	Ø 19 REF K.2518	Ø 30 REF K.257	Ø 19/19 REF K.2519	Ø 30/19 REF K.2521	Q	cm
1	75,785 €	103,523 €	129,582 €	162,748 €	16	150
1	85,054 €	114,885 €	148,12 €	175,329 €	20	200
1	110,469 €	147,982 €	187,956 €	221,536 €	26	250
1	119,14 €	159,62 €	205,298 €	241,845 €	30	300
1	*143,612 €	*192,579 €	*254,242 €	*299,276 €	40	400

Corona Trono



U	Ø 19 REF K.2618	Ø 30 REF K.2607	Ø 19/19 REF K.2619	Ø 30/19 REF K.2621	Q	cm
1	75,785 €	103,523 €	129,582 €	162,748 €	16	150
1	85,054 €	114,885 €	148,12 €	175,329 €	20	200
1	110,469 €	147,982 €	187,956 €	221,536 €	26	250
1	119,14 €	159,62 €	205,298 €	241,845 €	30	300
1	*143,612 €	*192,579 €	*254,242 €	*299,276 €	40	400

Cubis



U	Ø 19 REF K.7518	Ø 30 REF K.7507	Ø 19/19 REF K.7519	Ø 30/19 REF K.7521	Q	cm
1	76,94 €	100,07 €	131,88 €	160,45 €	16	150
1	86,20 €	111,44 €	150,42 €	173,03 €	20	200
1	111,62 €	144,53 €	190,26 €	219,24 €	26	250
1	120,29 €	156,17 €	207,60 €	239,55 €	30	300
1	*144,76 €	*189,13 €	*256,54 €	*296,98 €	40	400

Hoja



U	Ø 19 REF K.7618	Ø 30 REF K.7607	Ø 19/19 REF K.7619	Ø 30/19 REF K.7621	Q	cm
1	79,88 €	100,07 €	137,77 €	163,39 €	16	150
1	89,15 €	111,44 €	156,31 €	175,97 €	20	200
1	114,56 €	144,53 €	196,14 €	222,18 €	26	250
1	123,23 €	156,17 €	213,49 €	242,49 €	30	300
1	*147,71 €	*189,13 €	*262,43 €	*299,92 €	40	400

Púa



U	Ø 19 REF K.7818	Ø 30 REF K.7807	Ø 19/19 REF K.7819	Ø 30/19 REF K.7821	Q	cm
1	76,20 €	98,51 €	130,41 €	158,15 €	16	150
1	85,47 €	109,87 €	148,95 €	170,73 €	20	200
1	110,88 €	142,97 €	188,78 €	216,94 €	26	250
1	119,55 €	154,61 €	206,13 €	237,25 €	30	300
1	*144,03 €	*187,57 €	*255,07 €	*294,68 €	40	400

Corneta



U	Ø 19 REF K.7418	Ø 30 REF K.7407	Ø 19/19 REF K.7419	Ø 30/19 REF K.7421	Q	cm
1	88,02 €	109,46 €	154,05 €	172,87 €	16	150
1	97,29 €	120,82 €	172,59 €	193,50 €	20	200
1	122,71 €	153,92 €	212,43 €	239,71 €	26	250
1	131,38 €	165,55 €	229,77 €	260,02 €	30	300
1	*148,30 €	*198,51 €	*278,71 €	*317,45 €	40	400

Conjuntos completos CAVALLIER /
Complete sets CAVALLIER /
Kits complete CAVALLIER

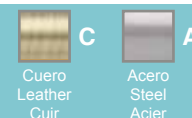

Sol

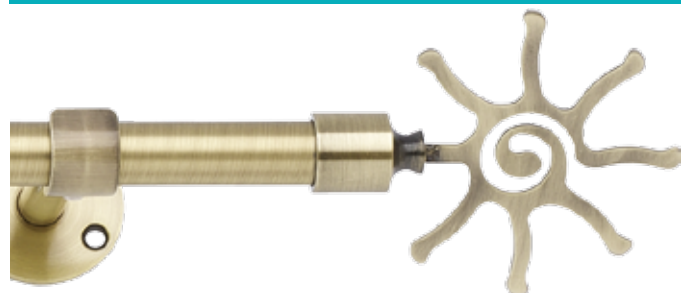

U	Ø 19 REF K.7218	Ø 30 REF K.7207	Ø 19/19 REF K.7219	Ø 30/19 REF K.7221	cm	cm
1	74,31 €	95,11 €	126,64 €	144,81 €	16	150
1	83,58 €	106,47 €	145,18 €	165,44 €	20	200
1	109,00 €	139,56 €	185,01 €	211,62 €	26	250
1	117,67 €	151,21 €	202,35 €	231,96 €	30	300
1	*142,14 €	*184,16 €	*251,30 €	*284,00 €	40	400

Terra



U	Ø 19 REF K.7318	Ø 30 REF K.7307	Ø 19/19 REF K.7319	Ø 30/19 REF K.7321	cm	cm
1	80,48 €	100,21 €	138,97 €	156,08 €	16	150
1	89,75 €	111,57 €	157,50 €	176,71 €	20	200
1	115,16 €	144,67 €	197,34 €	222,92 €	26	250
1	123,83 €	156,31 €	214,68 €	243,23 €	30	300
1	*148,30 €	*180,16 €	*263,63 €	*297,53 €	40	400

Espiral



U	Ø 19 REF K.7118	Ø 30 REF K.7107	Ø 19/19 REF K.7119	Ø 30/19 REF K.7121	cm	cm
1	74,96 €	95,70 €	127,93 €	146,05 €	16	150
1	84,23 €	107,07 €	146,46 €	166,68 €	20	200
1	109,64 €	140,16 €	186,30 €	212,89 €	26	250
1	118,31 €	151,80 €	203,64 €	233,20 €	30	300
1	*142,78 €	*184,76 €	*252,59 €	*290,63 €	40	400

Tapón



U	Ø 19 REF K.7718	Ø 30 REF K.7707	Ø 19/19 REF K.7719	Ø 30/19 REF K.7721	cm	cm
1	67,23 €	88,34 €	112,47 €	139,01 €	16	150
1	76,50 €	99,71 €	131,01 €	151,59 €	20	200
1	101,91 €	132,80 €	170,84 €	197,80 €	26	250
1	110,58 €	144,44 €	188,19 €	218,11 €	30	300
1	*135,06 €	*177,40 €	*237,13 €	*275,54 €	40	400

Contenido del Kit / Kit components / Composants du Kit

- * Se sirven empalmados.
 - Conjuntos Sencillos:
 2 terminales, 2 soportes, barra y anillas.
 - Conjuntos dobles:
 4 term., 2 sop.dobles, 2 barras y anillas.
 - Los conjuntos de medida superior a 2m se sirven con 3 soportes.
 - Indique en su pedido el acabado y la medida de la barra que desea.
 - Conjunto Dobles: Se sirven con el terminal tapón en la barra trasera.

- * Supplied in 2 halve.
 - Single sets:
 2 finials, 2 brackets, pole & rings.
 - Double sets:
 4 finials, 2 double brackets, 2 poles & rings.
 - All sets with a length longer than 2 meters are supplied with 3 brackets.
 -When ordering, please specify finish and size of pole.

- * Fourni en 2 parties.
 - Kits simples:
 2 embouts, 2 supports, tube et anneaux.
 - Kits doubles: 4 embouts, 2 supports doubles, 2 tubes et anneaux.
 - Tous les kits de mesures supérieures à 2 mètres contiennent 3 supports.
 - Merci de spécifier la finition et la taille de la barre.

Terminales / Finials / Embouts

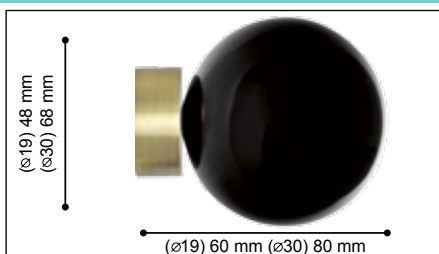
**Cosmos Negro**

REF	∅					
01374-P241908	19	2	21,62 €	24,86 €		
01374-CU241908	19	2	21,62 €	24,86 €		
01377-P243008	30	2	30,44 €	35,01 €		
01377-CU243008	30	2	30,44 €	35,01 €		

NEW

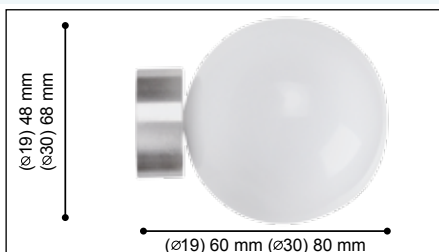
Cosmos Blanco

REF	∅					
01374-P241909	19	2	21,62 €	24,86 €		
01374-CU241909	19	2	21,62 €	24,86 €		
01377-P243009	30	2	30,44 €	35,01 €		
01377-CU243009	30	2	30,44 €	35,01 €		

NEW

Cosmos Oro

REF	∅					
01374-P241910	19	2	27,70 €	31,86 €		
01374-CU241910	19	2	27,70 €	31,86 €		
01377-P243010	30	2	41,92 €	48,21 €		
01377-CU243010	30	2	41,92 €	48,21 €		

NEW

Cosmos Bronce

REF	∅					
01374-P241911	19	2	27,70 €	31,86 €		
01374-CU241911	19	2	27,70 €	31,86 €		
01377-P243011	30	2	41,92 €	48,21 €		
01377-CU243011	30	2	41,92 €	48,21 €		

NEW

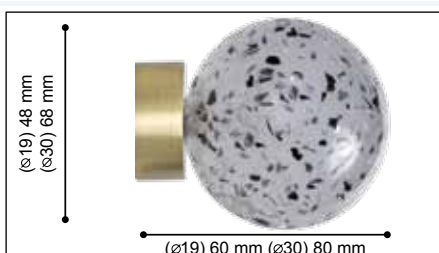
Cosmos Plata

REF	∅					
01374-P241912	19	2	27,70 €	31,86 €		
01374-CU241912	19	2	27,70 €	31,86 €		
01377-P243012	30	2	41,92 €	48,21 €		
01377-CU243012	30	2	41,92 €	48,21 €		

NEW

Corona Lisa

REF	∅					
01374-P251909	19	10	7,34 €	8,44 €		
01377-P253009	30	10	12,22 €	14,05 €		

NEW

Corona Altran con Cristales Swarovski®

REF	∅					
01374-P271909	19	2	23,10 €	26,57 €		
01377-P273009	30	2	28,02 €	32,22 €		

NEW

Corona Trono

REF	∅					
01374-P261909	19	10	7,34 €	8,44 €		
01377-P263009	30	10	12,22 €	14,05 €		

NEW

Terminales / Finials / Embouts



Cubis



REF	∅	U	€	€ ¹	cm
01374-P5219	19	10	7,84 €	9,02 €	
01374-CU5219	19	10	7,84 €	9,02 €	
01377-P5230	30	10	10,72 €	12,33 €	
01377-CU5230	30	10	10,72 €	12,33 €	

Hoja

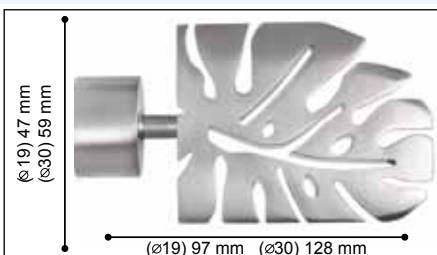

REF	∅	U	€	€ ¹	cm
01374-P5019	19	10	9,12 €	10,49 €	
01374-CU5019	19	10	9,12 €	10,49 €	
01377-P5030	30	10	10,72 €	12,33 €	
01377-CU5030	30	10	10,72 €	12,33 €	

Púa



REF	∅	U	€	€ ¹	cm
01374-P5119	19	10	7,52 €	8,65 €	
01374-CU5119	19	10	7,52 €	8,65 €	
01377-P5130	30	10	10,04 €	11,55 €	
01377-CU5130	30	10	10,04 €	11,55 €	

Corneta

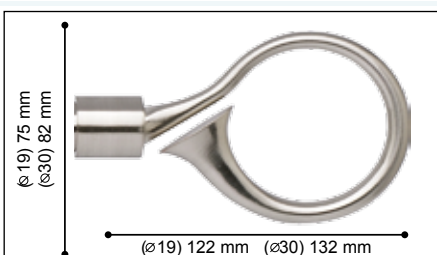

REF	∅	U	€	€ ¹	cm
01374-P6019	19	10	12,66 €	14,56 €	
01374-CU6019	19	10	12,66 €	14,56 €	
01377-P6030	30	10	14,80 €	17,02 €	
01377-CU6030	30	10	14,80 €	17,02 €	

Sol

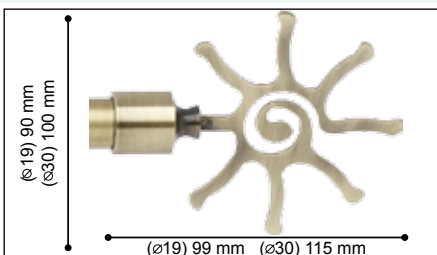

REF	∅	U	€	€ ¹	cm
01374-P5819	19	10	6,70 €	7,71 €	
01374-CU5819	19	10	6,70 €	7,71 €	
01377-P5830	30	10	8,56 €	9,84 €	
01377-CU5830	30	10	8,56 €	9,84 €	

Terra



REF	∅	U	€	€ ¹	cm
01374-P1619	19	10	9,38 €	10,79 €	
01374-CU1619	19	10	9,38 €	10,79 €	
01377-P1630	30	10	10,78 €	12,40 €	
01377-CU1630	30	10	10,78 €	12,40 €	

Espiral



REF	∅	U	€	€ ¹	cm
01374-P5919	19	10	6,98 €	8,03 €	
01374-CU5919	19	10	6,98 €	8,03 €	
01377-P5930	30	10	8,82 €	10,14 €	
01377-CU5930	30	10	8,82 €	10,14 €	

Tapón



REF	∅	U	€	€ ¹	cm
01374-P6119	19	10	3,62 €	4,16 €	
01374-CU6119	19	10	3,62 €	4,16 €	
01377-P6130	30	10	5,62 €	6,46 €	
01377-CU6130	30	10	5,62 €	6,46 €	

Accesorios / Accessories / Accessoires



Soporte extensible

Extendible wall
bracket /
Support
mur extensible

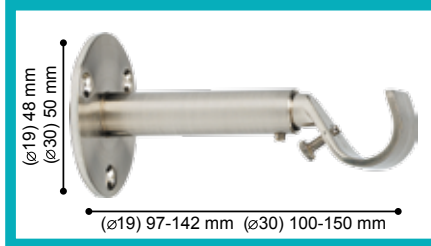

REF	∅				
01374-P20019	19	10	11,08 €	12,74 €	
01374-CU20019	19	10	11,08 €	12,74 €	
01377-P20030	30	10	12,54 €	14,42 €	
01377-CU20030	30	10	12,54 €	14,42 €	

* Soporte incluido en el Kit Sencillo / Bracket supplied in the Single Kit / Support fourni dans le Simple Kit.

Soporte doble extensible

Double extendible
wall bracket /
Support mur
extensible double

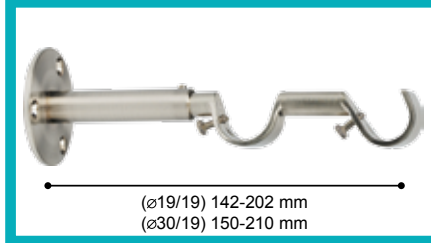

REF	∅				
01374-P21119	19/19	10	12,60 €	14,49 €	
01374-CU21119	19/19	10	12,60 €	14,49 €	
01377-P21319	30/19	10	12,92 €	14,86 €	
01377-CU21319	30/19	10	12,92 €	14,86 €	

* Soporte incluido en el Kit Doble / Bracket supplied in the Double Kit / Support fourni dans le Double Kit.

Soporte techo sencillo

Simple ceiling
bracket /
Support pla-
fond



REF	∅				
01374-P20119	19	10	4,96 €	5,70 €	
01374-CU20119	19	10	4,96 €	5,70 €	
01377-P20130	30	10	5,50 €	6,33 €	
01377-CU20130	30	10	5,50 €	6,33 €	

Soporte techo

Ceiling bracket /
Support plafond



REF	∅				
01374-P20919	19	10	11,92 €	13,71 €	
01374-CU20919	19	10	11,92 €	13,71 €	
01377-P20930	30	10	12,94 €	14,88 €	
01377-CU20930	30	10	12,94 €	14,88 €	

Soporte techo doble

Double ceiling
bracket /
Support plafond
double



REF	∅				
01374-P25119	19/19	10	15,60 €	17,94 €	
01374-CU25119	19/19	10	15,60 €	17,94 €	
01377-P25130	30/19	10	16,72 €	19,23 €	
01377-CU25130	30/19	10	16,72 €	19,23 €	

Soporte doble techo sencillo

Double ceiling bracket/
Support plafond
double



REF	∅				
01374-P22119	19/19	10	6,02 €	6,92 €	
01374-CU22119	19/19	10	6,02 €	6,92 €	
01377-P22319	30/19	10	7,22 €	8,30 €	
01377-CU22319	30/19	10	7,22 €	8,30 €	

Soporte dintel

Recess bracket /
Support entre-murs

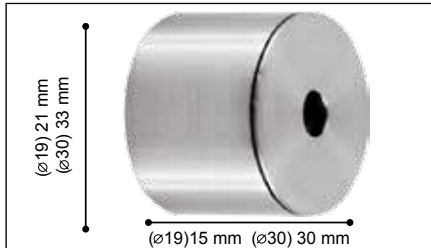

REF	∅				
01375-P20419	19	10	4,80 €	5,52 €	
01375-CU20419	19	10	4,80 €	5,52 €	
01376-P20430	30	10	6,98 €	8,03 €	
01376-CU20430	30	10	6,98 €	8,03 €	

Codo

Elbow /
Coude



REF	∅				
01374-PC	19	10	11,28 €	12,97 €	
01374-CUC	19	10	11,28 €	12,97 €	
01377-PC	30	10	16,96 €	19,50 €	
01377-CUC	30	10	16,96 €	19,50 €	

Accesorios / Accessories / Accessoires



Empalme

Splice /
Raccordeur

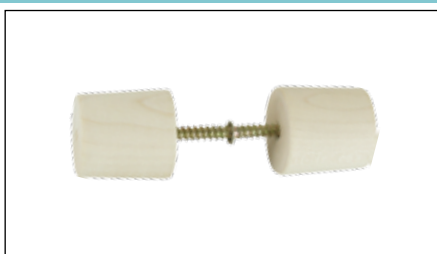

REF	∅	U	€	€ ¹	cm
02369-1517	19	10	2,72 €	3,13 €	
02368-1513	30	10	4,64 €	5,34 €	

Soporte Refuerzo
Extensible
15 cm - 20 cm
Reinforcing
extendible brackets
15-20cms /
Supports de renfor-
cement extensibles
15-20cms

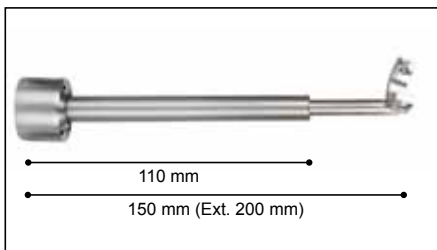

REF	∅	U	€	€ ¹	cm
01386-A502		10	19,38 €	22,29 €	
01386-CC502		10	19,38 €	22,29 €	

* Compatible con Soportes / Compatible with brackets / Compatible avec supports:

- S.20019A1
- S.20019C1
- S.20030A1
- S.20030C1
- S.21119A1
- S.21119C1
- S.21319A1
- S.21319C1

NEW

Anilla (10ud.)
con teflón

Ring (10 pieces)
with teflon /
Anneaux (10 pieces)
avec teflon

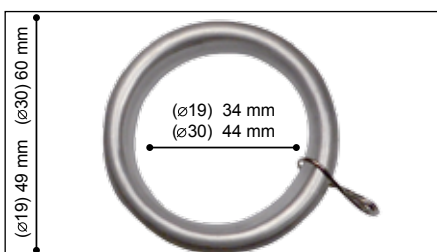

REF	∅	U	€	€ ¹	cm
01374-P20730	19	10	9,58 €	11,02 €	
01374-CU20730	19	10	9,58 €	11,02 €	
01377-P20830	30	10	11,56 €	13,29 €	
01377-CU20830	30	10	11,56 €	13,29 €	

Gancho

Hooks /
Gonds



REF	∅	U	€	€ ¹	cm
01376-PP		10	5,50 €	6,33 €	4,5
01376-CU		10	5,50 €	6,33 €	4,5

Prolongador

Spindle /
Balustre

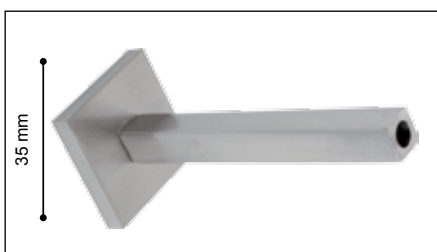

REF	∅	U	€	€ ¹	cm
01377-14AI		10	7,74 €	8,90 €	10
01377-14CI		10	7,74 €	8,90 €	10
01377-15AI		10	8,88 €	10,21 €	15
01377-15CI		10	8,88 €	10,21 €	15

Rosetón

Rosette /
Rosace

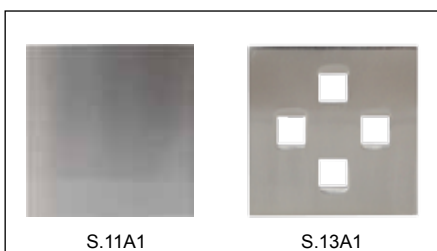

REF	∅	U	€	€ ¹	cm
01377-11AI		10	10,44 €	12,01 €	6
01377-11CI		10	10,44 €	12,01 €	6
01377-13AI		10	11,36 €	13,06 €	6
01377-13CI		10	11,36 €	13,06 €	6

Tirador 1 metro

Curtain Draw
Rod 1 m. /
Lance Rideau
1 m.



REF	∅	U	€	€ ¹	cm
01375-PTI		1		12,40 €	
01375-CUTI		1		12,40 €	

Barra Acero
PSteel Pole /
Tube AcierREF: **P**Barra Cuero
CULeather Pole /
Tube CuirREF: **CU**

REF	A	C	∅				
01374-150			19	10	12,92 €	14,86 €	150
01374-200			19	10	17,96 €	20,65 €	200
01374-250			19	10	22,42 €	25,78 €	250
01374-300			19	10	26,94 €	30,98 €	300
01377-150			30	10	20,26 €	23,30 €	150
01377-200			30	10	27,26 €	31,35 €	200
01377-250			30	10	34,82 €	40,04 €	250
01377-300			30	10	42,06 €	48,37 €	300

Expositor
CAVALLIER 1CAVALLIER 1
Display Board /
Presentoir
CAVALLIER 1

REF	∅				
M.206		1	53,04 €		

Expositor
CAVALLIER 2CAVALLIER 2
Display Board /
Presentoir
CAVALLIER 2

REF	∅				
M.216		1	53,04 €		

Expositor
CAVALLIER 3CAVALLIER 3
Display Board /
Presentoir
CAVALLIER 3

REF	∅				
M.220		1	122,00 €		

NEW

Marvent
SOLUCIONES PARA DECORAR VENTANAS

MOSQUITERA

Barra de Cortina VARADERO / Curtain Pole VARADERO / Tringle a Rideux VARADERO

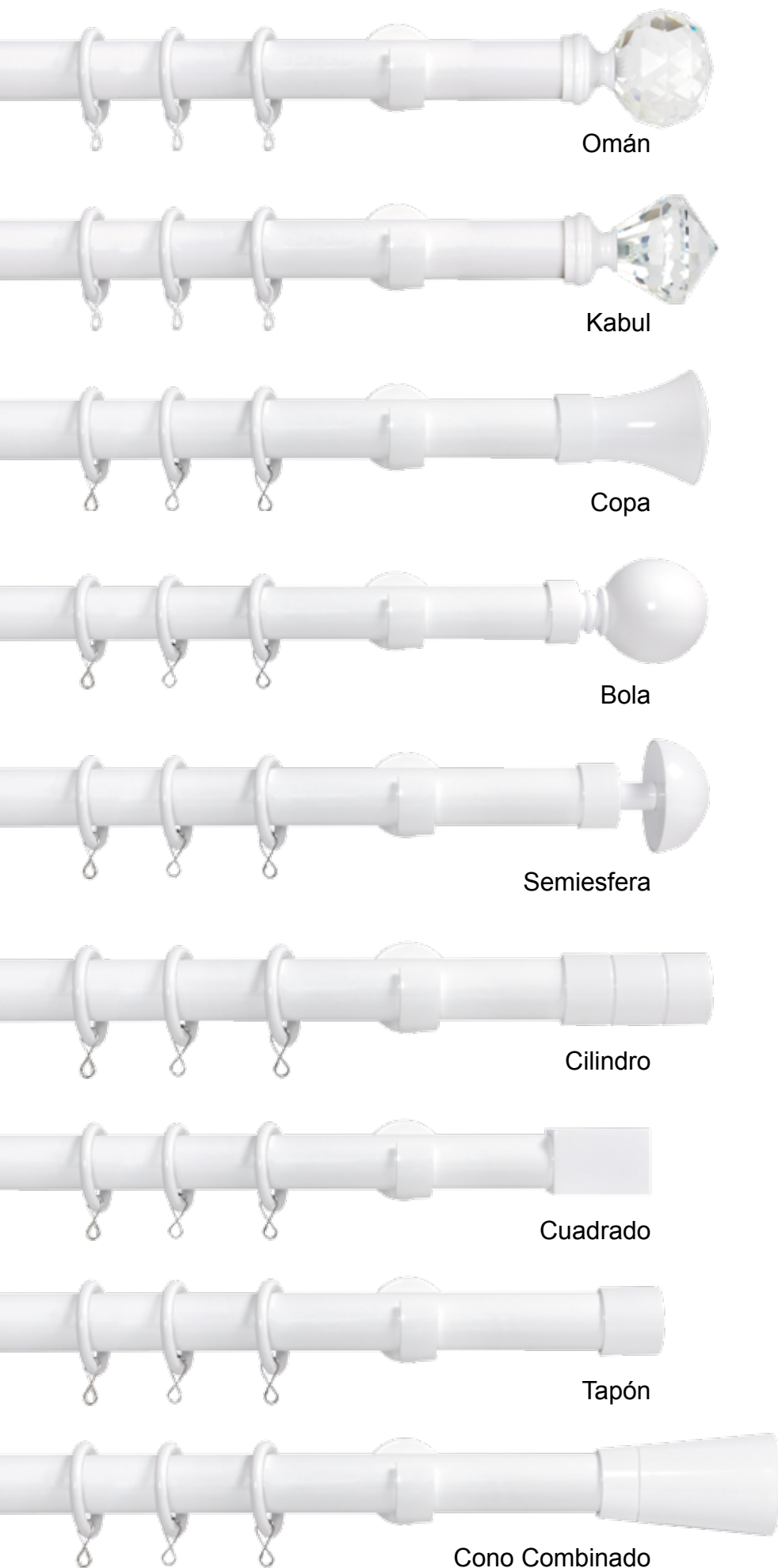

Omán

Kabul

Copa

Bola

Semiesfera

Cilindro

Cuadrado

Tapón

Cono Combinado

■ **Blanco /**
White /
Blanc

El Color Blanco manda en el mercado y por ello hemos diseñado seis de nuestros terminales, barras, soportes, anillas y complementos en color blanco para nuestra colección más famosa. También hemos completado la Colección Varadero con 4 Nuevos Terminales, atrevidos y modernos, en los colores clásicos.

La relación calidad-precio, hace de esta colección la mejor opción en esta gama y una de las más extensas y completas. Con estas Novedades, disponemos de 7 conjuntos en color blanco y 11 conjuntos más en colores plata mate, acero, cuero mate y cuero brillo. Por supuesto con sus complementos a juego.

White Colour is the leader option in the market and for this reason we have designed six of our existing finials in this new modern colour. Of course we have also introduced the white colour to poles, brackets, rings and accessories. Moreover, we have enlarged this collection with 4 new finials in the classic 4 colours to complete the best collection on the market.

Its quality-price relationship makes this collection the best choice in the range and one of the most extensive and complete. With these new developments, we offer our clients we come up with 7 new sets in white and 11 new sets in classic colours matt silver, steel, matt leather and bright leather.

La couleur blanche est l'option leader sur le marché et c'est pourquoi que nous avons conçu sis de nos embouts existants dans cette nouvelle couleur moderne. Bien sûr, nous avons également introduit la couleur blanche aux pôles, supports, anneaux et accessoires. En outre, nous avons élargi cette collection avec 4 nouveaux embouts dans les 4 couleurs classiques pour compléter la collection meilleure sur le marché.

Son rapport qualité-prix rend cette collection le meilleur choix dans la gamme et l'une des plus vaste et complète. Avec ces nouveaux développements, nous offrons nos clients 7 nouveaux kits en blanc et 11 nouveaux en les couleurs classiques, acier matt, inox ,cuir matt et en cuir brillant.

Ø 19 / 30 mm

Cuero Brillo
Leather
Cuir

Cuero Mate
Matt Leather
Cuir Matt



Omán



Omán



Kabul



Kabul



Tors



Tors



Truncado



Truncado



Copa Combinada



Copa Combinada



Cono Combinado



Cono Combinado

Ø 19 / 30 mm

Acero ■
Steel
Acier

■ Plata Mate
Matt Nickel
Nickel Satiné



Omán



Omán



Kabul



Kabul



Tors



Tors



Truncado



Truncado



Copa Combinada



Copa Combinada



Cono Combinado



Cono Combinado

∅ 19 / 30 mm

Cuero Brillo
Leather
Cuir

Cuero Mate
Matt Leather
Cuir Matt



Discos



Discos



Bola



Bola



Semiesfera



Semiesfera



Cilindro



Cilindro



Cuadrado



Cuadrado



Tapón



Tapón

Ø 19 / 30 mm

Acero ■
Steel
Acier

■ Plata Mate
Matt Nickel
Nickel Satiné



Discos



Discos



Bola



Bola



Semiesfera



Semiesfera



Cilindro



Cilindro



Cuadrado



Cuadrado



Tapón



Tapón

Ø 19 / 30 mm

VARADERO

Conjuntos completos VARADERO /
Complete sets VARADERO /
Kits complete VARADERO

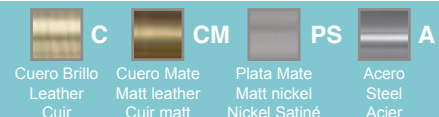

Omán



	Ø 19 REF K.16918	Ø 30 REF K.16907	Ø 19/19 REF K.16919	Ø 30/19 REF K.16921		
1	57,02 €	85,58 €	86,71 €	113,51 €	16	150
1	70,24 €	92,79 €	108,97 €	139,22 €	20	200
1	76,69 €	111,46 €	121,86 €	153,99 €	26	250
1	82,03 €	120,95 €	132,55 €	168,83 €	30	300

Kabul



	Ø 19 REF K.17018	Ø 30 REF K.17007	Ø 19/19 REF K.17019	Ø 30/19 REF K.17021		
1	57,02 €	85,58 €	86,71 €	113,51 €	16	150
1	70,24 €	92,79 €	108,97 €	139,22 €	20	200
1	76,69 €	111,46 €	121,86 €	153,99 €	26	250
1	82,03 €	120,95 €	132,55 €	168,83 €	30	300

Tors



	Ø 19 REF K.17618	Ø 30 REF K.17607	Ø 19/19 REF K.17619	Ø 30/19 REF K.17621		
1	53,28 €	75,93 €	82,97 €	103,86 €	16	150
1	66,50 €	83,13 €	105,23 €	129,56 €	20	200
1	72,95 €	101,80 €	118,12 €	144,34 €	26	250
1	78,29 €	111,29 €	128,81 €	159,17 €	30	300

Truncado



	Ø 19 REF K.17718	Ø 30 REF K.17707	Ø 19/19 REF K.17719	Ø 30/19 REF K.17721		
1	49,63 €	72,43 €	79,31 €	100,36 €	16	150
1	62,85 €	79,63 €	101,58 €	126,06 €	20	200
1	69,29 €	98,30 €	114,47 €	140,84 €	26	250
1	74,64 €	107,79 €	125,16 €	155,68 €	30	300

Discos



	Ø 19 REF K.17818	Ø 30 REF K.17807	Ø 19/19 REF K.17819	Ø 30/19 REF K.17821		
1	49,63 €	72,43 €	79,31 €	100,36 €	16	150
1	62,85 €	79,63 €	101,58 €	126,06 €	20	200
1	69,29 €	98,30 €	114,47 €	140,84 €	26	250
1	74,64 €	107,79 €	125,16 €	155,68 €	30	300

Copa Combinada



	Ø 19 REF K.17918	Ø 30 REF K.17907	Ø 19/19 REF K.17919	Ø 30/19 REF K.17921		
1	55,13 €	76,34 €	84,81 €	104,27 €	16	150
1	68,35 €	83,55 €	107,08 €	129,98 €	20	200
1	74,79 €	102,22 €	119,97 €	144,75 €	26	250
1	80,14 €	111,71 €	130,66 €	159,59 €	30	300

Cono Combinado



	Ø 19 REF K.16618	Ø 30 REF K.16607	Ø 19/19 REF K.16619	Ø 30/19 REF K.16621		
1	51,74 €	78,98 €	81,43 €	106,91 €	16	150
1	64,96 €	86,19 €	103,69 €	132,62 €	20	200
1	71,41 €	104,86 €	116,58 €	147,39 €	26	250
1	76,75 €	114,35 €	127,27 €	162,23 €	30	300

Conjuntos completos VARADERO /
Complete sets VARADERO /
Kits complete VARADERO



Copa



U	Ø 19 REF K.16218	Ø 30 REF K.16207	Ø 19/19 REF K.16219	Ø 30/19 REF K.16221	cm
1	49,10 €	73,04 €	78,79 €	100,97 €	16
1	62,32 €	80,25 €	101,05 €	126,68 €	20
1	68,77 €	98,92 €	113,94 €	141,45 €	26
1	74,11 €	108,41 €	124,63 €	156,29 €	30

Bola



U	Ø 19 REF K.16018	Ø 30 REF K.16007	Ø 19/19 REF K.16019	Ø 30/19 REF K.16021	cm
1	49,10 €	73,04 €	78,79 €	100,97 €	16
1	62,32 €	80,25 €	101,05 €	126,68 €	20
1	68,77 €	98,92 €	113,94 €	141,45 €	26
1	74,11 €	108,41 €	124,63 €	156,29 €	30

Semiesfera



U	Ø 19 REF K.16418	Ø 30 REF K.16407	Ø 19/19 REF K.16419	Ø 30/19 REF K.16421	cm
1	49,10 €	73,04 €	78,79 €	100,97 €	16
1	62,32 €	80,25 €	101,05 €	126,68 €	20
1	68,77 €	98,92 €	113,94 €	141,45 €	26
1	74,11 €	108,41 €	124,63 €	156,29 €	30

Cilindro



U	Ø 19 REF K.16118	Ø 30 REF K.16107	Ø 19/19 REF K.16119	Ø 30/19 REF K.16121	cm
1	49,10 €	73,04 €	78,79 €	100,97 €	16
1	62,32 €	80,25 €	101,05 €	126,68 €	20
1	68,77 €	98,92 €	113,94 €	141,45 €	26
1	74,11 €	108,41 €	124,63 €	156,29 €	30

Cuadrado



U	Ø 19 REF K.16318	Ø 30 REF K.16307	Ø 19/19 REF K.16319	Ø 30/19 REF K.16321	cm
1	49,10 €	73,04 €	78,79 €	100,97 €	16
1	62,32 €	80,25 €	101,05 €	126,68 €	20
1	68,77 €	98,92 €	113,94 €	141,45 €	26
1	74,11 €	108,41 €	124,63 €	156,29 €	30

Tapón



U	Ø 19 REF K.16518	Ø 30 REF K.16507	Ø 19/19 REF K.16519	Ø 30/19 REF K.16521	cm
1	38,05 €	58,30 €	67,74 €	86,23 €	16
1	51,28 €	65,51 €	90,01 €	111,94 €	20
1	57,72 €	84,18 €	102,90 €	126,71 €	26
1	63,07 €	93,67 €	113,59 €	141,55 €	30

Contenido del Kit / Kit components / Composants du Kit

Conjuntos Sencillos :

- 19 mm: 2 terminales, 2 soportes, barra y anillas (medidas superior a 1,50 m. 3 soportes).
- 30 mm: 2 terminales, 2 soportes, barra y anillas (medidas superior a 2,00 m. 3 soportes)

Las barras dobles están valoradas con terminal tapón en la barra trasera.

VARADERO

Conjuntos completos VARADERO (anilla con teflón) /
Complete sets VARADERO /
Kits complete VARADERO

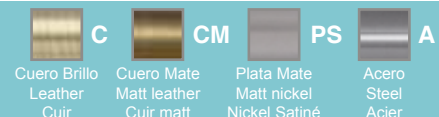

Omán



	Ø 19 REF K.16918	Ø 30 REF K.16907	Ø 19/19 REF K.16919	Ø 30/19 REF K.16921		
1	62,30 €	92,98 €	97,27 €	126,19 €	16	150
1	76,84 €	102,03 €	122,17 €	155,06 €	20	200
1	85,27 €	123,47 €	139,02 €	174,59 €	26	250
1	91,93 €	134,81 €	152,35 €	192,59 €	30	300

Kabul



	Ø 19 REF K.17018	Ø 30 REF K.17007	Ø 19/19 REF K.17019	Ø 30/19 REF K.17021		
1	62,30 €	92,98 €	97,27 €	126,19 €	16	150
1	76,84 €	102,03 €	122,17 €	155,06 €	20	200
1	85,27 €	123,47 €	139,02 €	174,59 €	26	250
1	91,93 €	134,81 €	152,35 €	192,59 €	30	300

Tors



	Ø 19 REF K.17618	Ø 30 REF K.17607	Ø 19/19 REF K.17619	Ø 30/19 REF K.17621		
1	58,56 €	83,32 €	93,53 €	116,53 €	16	150
1	73,10 €	92,37 €	118,43 €	145,40 €	20	200
1	81,53 €	113,81 €	135,28 €	164,93 €	26	250
1	88,19 €	1125,15 €	148,61 €	182,93 €	30	300

Truncado



	Ø 19 REF K.17718	Ø 30 REF K.17707	Ø 19/19 REF K.17719	Ø 30/19 REF K.17721		
1	54,91 €	79,82 €	89,87 €	113,03 €	16	150
1	69,45 €	88,87 €	114,78 €	141,90 €	20	200
1	77,87 €	110,31 €	131,63 €	161,43 €	26	250
1	84,54 €	121,65 €	144,96 €	179,44 €	30	300

Discos



	Ø 19 REF K.17818	Ø 30 REF K.17807	Ø 19/19 REF K.17819	Ø 30/19 REF K.17821		
1	54,91 €	79,82 €	89,87 €	113,03 €	16	150
1	69,45 €	88,87 €	114,78 €	141,90 €	20	200
1	77,87 €	110,31 €	131,63 €	161,43 €	26	250
1	84,54 €	121,65 €	144,96 €	179,44 €	30	300

Copa Combinada



	Ø 19 REF K.17918	Ø 30 REF K.17907	Ø 19/19 REF K.17919	Ø 30/19 REF K.17921		
1	60,41 €	83,74 €	95,37 €	116,95 €	16	150
1	74,95 €	92,79 €	120,28 €	145,82 €	20	200
1	83,37 €	114,23 €	137,913 €	165,35 €	26	250
1	90,04 €	125,57 €	150,46 €	183,35 €	30	300

Cono Combinado



	Ø 19 REF K.16618	Ø 30 REF K.16607	Ø 19/19 REF K.16619	Ø 30/19 REF K.16621		
1	57,02 €	86,38 €	91,99 €	119,59 €	16	150
1	71,56 €	95,43 €	116,89 €	148,46 €	20	200
1	79,99 €	116,87 €	133,74 €	167,99 €	26	250
1	86,65 €	128,21 €	147,07 €	185,99 €	30	300

Conjuntos completos VARADERO (anilla con teflón) /
Complete sets VARADERO /
Kits complete VARADERO

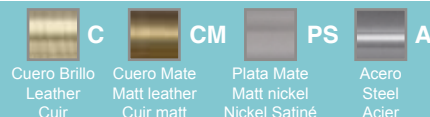

Copa



U	Ø 19 REF K.16218	Ø 30 REF K.16207	Ø 19/19 REF K.16219	Ø 30/19 REF K.16221	cm
1	54,38 €	80,44 €	89,35 €	113,65 €	16
1	68,92 €	89,49 €	114,25 €	142,52 €	20
1	77,35 €	110,93 €	131,10 €	162,05 €	26
1	84,01 €	122,27 €	144,43 €	180,05 €	30

Bola



U	Ø 19 REF K.16018	Ø 30 REF K.16007	Ø 19/19 REF K.16019	Ø 30/19 REF K.16021	cm
1	54,38 €	80,44 €	89,35 €	113,65 €	16
1	68,92 €	89,49 €	114,25 €	142,52 €	20
1	77,35 €	110,93 €	131,10 €	162,05 €	26
1	84,01 €	122,27 €	144,43 €	180,05 €	30

Semiesfera



U	Ø 19 REF K.16418	Ø 30 REF K.16407	Ø 19/19 REF K.16419	Ø 30/19 REF K.16421	cm
1	54,38 €	80,44 €	89,35 €	113,65 €	16
1	68,92 €	89,49 €	114,25 €	142,52 €	20
1	77,35 €	110,93 €	131,10 €	162,05 €	26
1	84,01 €	122,27 €	144,43 €	180,05 €	30

Cilindro



U	Ø 19 REF K.16118	Ø 30 REF K.16107	Ø 19/19 REF K.16119	Ø 30/19 REF K.16121	cm
1	54,38 €	80,44 €	89,35 €	113,65 €	16
1	68,92 €	89,49 €	114,25 €	142,52 €	20
1	77,35 €	110,93 €	131,10 €	162,05 €	26
1	84,01 €	122,27 €	144,43 €	180,05 €	30

Cuadrado



U	Ø 19 REF K.16318	Ø 30 REF K.16307	Ø 19/19 REF K.16319	Ø 30/19 REF K.16321	cm
1	54,38 €	80,44 €	89,35 €	113,65 €	16
1	68,92 €	89,49 €	114,25 €	142,52 €	20
1	77,35 €	110,93 €	131,10 €	162,05 €	26
1	84,01 €	122,27 €	144,43 €	180,05 €	30

Tapón



U	Ø 19 REF K.16518	Ø 30 REF K.16507	Ø 19/19 REF K.16519	Ø 30/19 REF K.16521	cm
1	43,33 €	65,70 €	78,30 €	98,91 €	16
1	57,88 €	74,75 €	103,21 €	127,78 €	20
1	66,30 €	96,19 €	120,06 €	147,31 €	26
1	72,97 €	107,53 €	133,39 €	165,31 €	30

Contenido del Kit / Kit components / Composants du Kit

Conjuntos Sencillos :

- 19 mm: 2 terminales, 2 soportes, barra y anillas (medidas superior a 1,50 m. 3 soportes).
- 30 mm: 2 terminales, 2 soportes, barra y anillas (medidas superior a 2,00 m. 3 soportes)

Las barras dobles están valoradas con terminal tapón en la barra trasera.

VARADERO

Conjuntos completos VARADERO (anilla con teflón) /
Complete sets VARADERO /
Kits complete VARADERO

BL
Blanco
White
Blanc

Omán



	∅ 19 REF K.16907	∅ 30 REF K.16907	∅ 19/19 REF K.16919	∅ 30/19		
1	62,30 €	92,98 €	97,27 €	126,19 €	16	150
1	76,84 €	102,03 €	122,17 €	155,06 €	20	200
1	85,27 €	123,47 €	139,02 €	174,59 €	26	250
1	91,93 €	134,81 €	152,35 €	192,59 €	30	300

Kabul



	∅ 19 REF K.17018	∅ 30 REF K.17007	∅ 19/19	∅ 30/19 REF K.17021		
1	62,30 €	92,98 €	97,27 €	126,19 €	16	150
1	76,84 €	102,03 €	122,17 €	155,06 €	20	200
1	85,27 €	123,47 €	139,02 €	174,59 €	26	250
1	91,93 €	134,81 €	152,35 €	192,59 €	30	300

Cono



	∅ 19 REF K.16618	∅ 30 REF K.16607	∅ 19/19 REF K.16619	∅ 30/19 REF K.16621		
1	57,02 €	86,38 €	91,99 €	119,59 €	16	150
1	71,56 €	95,43 €	116,89 €	148,46 €	20	200
1	79,99 €	116,87 €	133,74 €	167,99 €	26	250
1	86,65 €	128,21 €	147,07 €	185,99 €	30	300

Copa



	∅ 19 REF K.16218	∅ 30 REF K.16207	∅ 19/19 REF K.16219	∅ 30/19 REF K.16221		
1	54,38 €	80,44 €	89,35 €	113,65 €	16	150
1	68,92 €	89,49 €	114,25 €	142,52 €	20	200
1	77,35 €	110,93 €	131,10 €	162,05 €	26	250
1	84,01 €	122,27 €	144,43 €	180,05 €	30	300

Bola



	∅ 19 REF K.16018	∅ 30 REF K.16007	∅ 19/19 REF K.16019	∅ 30/19 REF K.16021		
1	54,38 €	80,44 €	89,35 €	113,65 €	16	150
1	68,92 €	89,49 €	114,25 €	142,52 €	20	200
1	77,35 €	110,93 €	131,10 €	162,05 €	26	250
1	84,01 €	122,27 €	144,43 €	180,05 €	30	300

Semiesfera



	∅ 19 REF K.16418	∅ 30 REF K.16407	∅ 19/19 REF K.16419	∅ 30/19 REF K.16421		
1	54,38 €	80,44 €	89,35 €	113,65 €	16	150
1	68,92 €	89,49 €	114,25 €	142,52 €	20	200
1	77,35 €	110,93 €	131,10 €	162,05 €	26	250
1	84,01 €	122,27 €	144,43 €	180,05 €	30	300

Conjuntos completos VARADERO (anilla con teflón) /
Complete sets VARADERO /
Kits complete VARADERO

BL
Blanco
White
Blanc

Cilindro



U	Ø 19 REF K.16118	Ø 30 REF K.16107	Ø 19/19 REF K.16119	Ø 30/19 REF K.16121	cm	cm
1	54,38 €	80,44 €	89,35 €	113,65 €	16	150
1	68,92 €	89,49 €	114,25 €	142,52 €	20	200
1	77,35 €	110,93 €	131,10 €	162,05 €	26	250
1	84,01 €	122,27 €	144,43 €	180,05 €	30	300

Cuadrado



U	Ø 19 REF K.16318	Ø 30 REF K.16307	Ø 19/19 REF K.16319	Ø 30/19 REF K.16321	cm	cm
1	54,38 €	80,44 €	89,35 €	113,65 €	16	150
1	68,92 €	89,49 €	114,25 €	142,52 €	20	200
1	77,35 €	110,93 €	131,10 €	162,05 €	26	250
1	84,01 €	122,27 €	144,43 €	180,05 €	30	300

Tapón



U	Ø 19 REF K.16518	Ø 30 REF K.16507	Ø 19/19 REF K.16519	Ø 30/19 REF K.16521	cm	cm
1	43,33 €	65,70 €	78,30 €	98,91 €	16	150
1	57,88 €	74,75 €	103,21 €	127,78 €	20	200
1	66,30 €	96,19 €	120,06 €	147,31 €	26	250
1	72,97 €	107,53 €	133,39 €	165,31 €	30	300

Contenido del Kit / Kit components / Composants du Kit

- Conjuntos Sencillos :
- 19 mm: 2 terminales, 2 soportes, barra y anillas (medidas superior a 1,50 m. 3 soportes).
 - 30 mm: 2 terminales, 2 soportes, barra y anillas (medidas superior a 2,00 m. 3 soportes)
- Las barras dobles están valoradas con terminal tapón en la barra trasera.



Terminales / Finials / Embouts



Tors

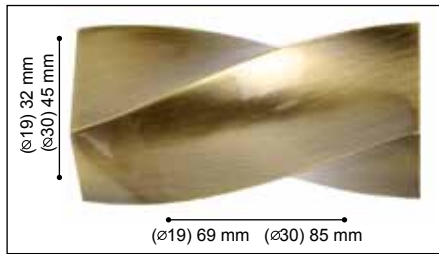

	∅					
01386-A2030	19	10	8,70 €	9,57 €		
01386-CC2030	19	10	8,70 €	9,57 €		
01386-CU2030	19	10	8,70 €	9,57 €		
01386-P2030	19	10	8,70 €	9,57 €		
01387-A2031	30	10	12,11 €	12,48 €		
01387-CC2031	30	10	12,11 €	112,48 €		
01387-CU2031	30	10	12,11 €	12,48 €		
01387-P2031	30	10	12,11 €	12,48 €		

Truncado



REF	∅					
01386-A2028	19	10	7,04 €	7,75 €		
01386-CC2028	19	10	7,04 €	7,75 €		
01386-CU2028	19	10	7,04 €	7,75 €		
01386-P2028	19	10	7,04 €	7,75 €		
01387-A2029	30	10	10,52 €	11,58 €		
01387-CC2029	30	10	10,52 €	11,58 €		
01387-CU2029	30	10	10,52 €	11,58 €		
01387-P2029	30	10	10,52 €	11,58 €		

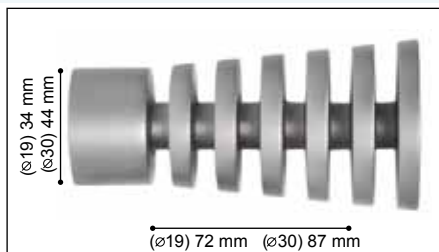

REF	∅					
01386-A2032	19	10	7,04 €	7,75 €		
01386-CC2032	19	10	7,04 €	7,75 €		
01386-CU2032	19	10	7,04 €	7,75 €		
01386-P2032	19	10	7,04 €	7,75 €		
01387-A2033	30	10	10,52 €	11,58 €		
01387-CC2033	30	10	10,52 €	11,58 €		
01387-CU2033	30	10	10,52 €	11,58 €		
01387-P2033	30	10	10,52 €	11,58 €		

Copa Combinada

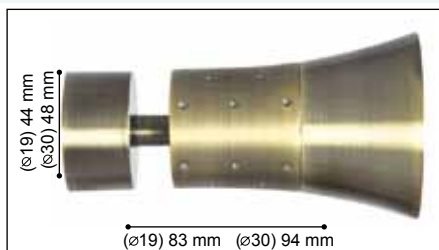

	∅					
01386-A2034	19	10	9,54 €	10,50 €		
01386-CC2034	19	10	9,54 €	10,50 €		
01387-A2034	30	10	12,30 €	13,53 €		
01387-CC2034	30	10	12,30 €	13,53 €		

Terminales / Finials / Embouts



Cono



REF	∅	U	€	1	cm
01386-P2024	19	10	8,00 €	8,80 €	
01386-B2024	19	10	8,00 €	8,80 €	
01386-CU2024	19	10	8,00 €	8,80 €	
01387-P2025	30	10	13,50 €	14,85 €	
01387-B2025	30	10	13,50 €	14,85 €	
01387-CU2025	30	10	13,50 €	14,85 €	

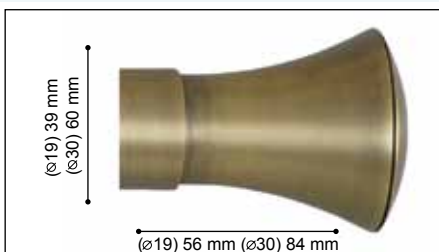

REF	∅	U	€	1	cm
01386-A2013	19	10	6,80 €	7,48 €	
01386-B2013	19	10	6,80 €	7,48 €	
01386-CC2013	19	10	6,80 €	7,48 €	
01386-CU2013	19	10	6,80 €	7,48 €	
01386-P2013	19	10	6,80 €	7,48 €	
01387-A2016	30	10	10,80 €	11,88 €	
01387-B2016	30	10	10,80 €	11,88 €	
01387-CC2016	30	10	10,80 €	11,88 €	
01387-CU2016	30	10	10,80 €	11,88 €	
01387-P2016	30	10	10,80 €	11,88 €	

Bola



REF	∅	U	€	1	cm
01386-A2021	19	10	6,80 €	7,48 €	
01386-B2021	19	10	6,80 €	7,48 €	
01386-CC2021	19	10	6,80 €	7,48 €	
01386-CU2021	19	10	6,80 €	7,48 €	
01386-P2021	19	10	6,80 €	7,48 €	
01387-A2023	30	10	10,80 €	11,88 €	
01387-B2023	30	10	10,80 €	11,88 €	
01387-CC2023	30	10	10,80 €	11,88 €	
01387-CU2023	30	10	10,80 €	11,88 €	
01387-P2023	30	10	10,80 €	11,88 €	

Semiesfera



REF	∅	U	€	1	cm
01386-A2015	19	10	6,80 €	7,48 €	
01386-B2015	19	10	6,80 €	7,48 €	
01386-CC2015	19	10	6,80 €	7,48 €	
01386-CU2015	19	10	6,80 €	7,48 €	
01386-P2015	19	10	6,80 €	7,48 €	
01387-A2017	30	10	10,80 €	11,88 €	
01387-B2017	30	10	10,80 €	11,88 €	
01387-CC2017	30	10	10,80 €	11,88 €	
01387-CU2017	30	10	10,80 €	11,88 €	
01387-P2017	30	10	10,80 €	11,88 €	

Terminales / Finials / Embouts



Cilindro



REF	∅				
01386-A2012	19	10	6,80 €	7,48 €	
01386-B2012	19	10	6,80 €	7,48 €	
01386-CC2012	19	10	6,80 €	7,48 €	
01386-CU2012	19	10	6,80 €	7,48 €	
01386-P2012	19	10	6,80 €	7,48 €	
01387-A2018	30	10	10,80 €	11,88 €	
01387-B2018	30	10	10,80 €	11,88 €	
01387-CC2018	30	10	10,80 €	11,88 €	
01387-CU2018	30	10	10,80 €	11,88 €	
01387-P2018	30	10	10,80 €	11,88 €	

Cuadrado

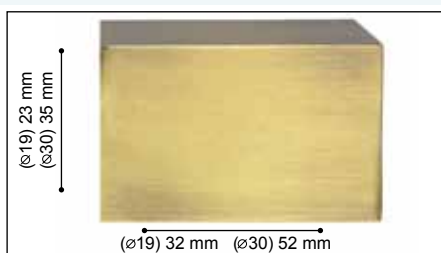

REF	∅				
01386-A2020	19	10	6,80 €	7,48 €	
01386-B2020	19	10	6,80 €	7,48 €	
01386-CC2020	19	10	6,80 €	7,48 €	
01386-CU2020	19	10	6,80 €	7,48 €	
01386-P2020	19	10	6,80 €	7,48 €	
01387-A2022	30	10	10,80 €	11,88 €	
01387-B2022	30	10	10,80 €	11,88 €	
01387-CC2022	30	10	10,80 €	11,88 €	
01387-CU2022	30	10	10,80 €	11,88 €	
01387-P2022	30	10	10,80 €	11,88 €	

Tapón

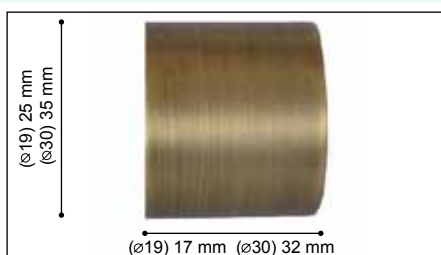

REF	∅				
01386-A6119	19	10	1,78 €	1,96 €	
01386-B6119	19	10	1,78 €	1,96 €	
01386-CC6119	19	10	1,78 €	1,96 €	
01386-CU6119	19	10	1,78 €	1,96 €	
01386-P6119	19	10	1,78 €	1,96 €	
01387-A6130	30	10	4,10 €	4,51 €	
01387-B6130	30	10	4,10 €	4,51 €	
01387-CC6130	30	10	4,10 €	4,51 €	
01387-CU6130	30	10	4,10 €	4,51 €	
01387-P6130	30	10	4,10 €	4,51 €	

Omán



REF	∅				
01386-A2036	19	10	10,40 €	11,44 €	
01386-B2036	19	10	10,40 €	11,44 €	
01386-CC2036	19	10	10,40 €	11,44 €	
01386-CU2036	19	10	10,40 €	11,44 €	
01386-P2036	19	10	10,40 €	11,44 €	
01387-A2037	30	10	16,50 €	18,15 €	
01387-B2037	30	10	16,50 €	18,15 €	
01387-CC2037	30	10	16,50 €	18,15 €	
01387-CU2037	30	10	16,50 €	18,15 €	
01387-P2037	30	10	16,50 €	18,15 €	

Terminales / Finials / Embouts

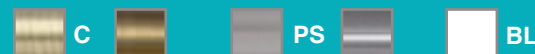

Kabul



REF	∅	U	€	1	cm
01386-A2038	19	10	10,40 €	11,44 €	
01386-B2038	19	10	10,40 €	11,44 €	
01386-CC2038	19	10	10,40 €	11,44 €	
01386-CU2038	19	10	10,40 €	11,44 €	
01386-P2038	19	10	10,40 €	11,44 €	
01387-A2039	30	10	16,50 €	18,15 €	
01387-B2039	30	10	16,50 €	18,15 €	
01387-CC2039	30	10	16,50 €	18,15 €	
01387-CU2039	30	10	16,50 €	18,15 €	
01387-P2039	30	10	16,50 €	18,15 €	

Accesorios / Accessories / Accessoires



Soporte Extensible
12,5 cm - 17,5 cm

Extendible
bracket /
Support
Extensible

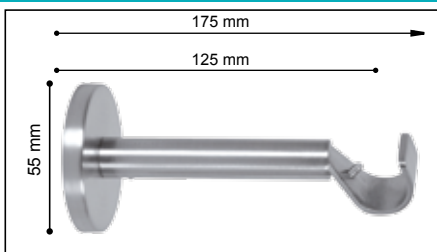

REF	∅	U	€	1	cm
01386-A4007	19	10	8,10 €	8,91 €	
01386-B4007	19	10	8,10 €	8,91 €	
01386-CC4007	19	10	8,10 €	8,91 €	
01386-CU4007	19	10	8,10 €	8,91 €	
01386-P4007	19	10	8,10 €	8,91 €	

Soporte Extensible
13,5 cm - 18,5 cm

Extendible
bracket /
Support
Extensible

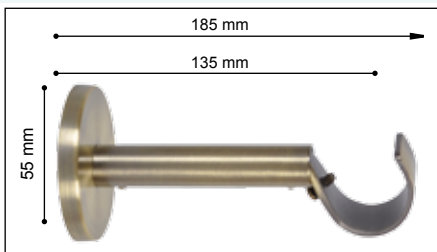

REF	∅	U	€	1	cm
01387-A4010	30	10	9,32 €	10,26 €	
01387-B4010	30	10	9,32 €	10,26 €	
01387-CC4010	30	10	9,32 €	10,26 €	
01387-CU4010	30	10	9,32 €	10,26 €	
01387-P4010	30	10	9,32 €	10,26 €	

Soporte Pared

Wall Bracket /
Support Mur

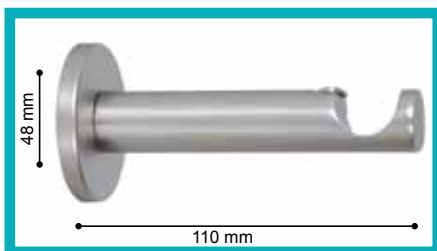

REF	∅	U	€	1	cm
01386-A4008	19	10	7,20 €	7,92 €	
01386-B4008	19	10	7,20 €	7,92 €	
01386-CC4008	19	10	7,20 €	7,92 €	
01386-CU4008	19	10	7,20 €	7,92 €	
01386-P4008	19	10	7,20 €	7,92 €	

* Soporte incluido en el Kit Sencillo / Bracket supplied in the Single Kit / Support fourni dans le Simple Kit.

Soporte Pared

Wall Bracket /
Support Bur

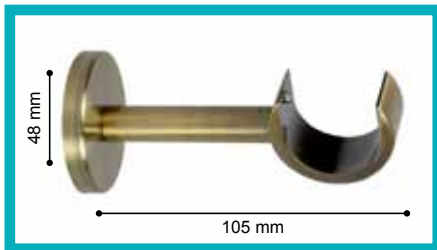

REF	∅	U	€	1	cm
01387-A4011	30	10	9,40 €	10,34 €	
01387-B4011	30	10	9,40 €	10,34 €	
01387-CC4011	30	10	9,40 €	10,34 €	
01387-CU4011	30	10	9,40 €	10,34 €	
01387-P4011	30	10	9,40 €	10,34 €	

* Soporte incluido en el Kit Sencillo / Bracket supplied in the Single Kit / Support fourni dans le Simple Kit.

Soporte
Doble Pared

Double Wall Bracket /
Support mur double

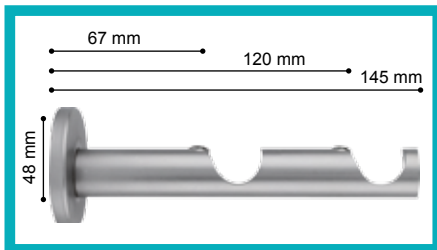

REF	∅	U	€	1	cm
01386-A4016	19 / 19	10	10,60 €	11,66 €	
01386-A4016	19 / 19	10	10,60 €	11,66 €	
01386-A4016	19 / 19	10	10,60 €	11,66 €	
01386-A4016	19 / 19	10	10,60 €	11,66 €	
01386-A4016	19 / 19	10	10,60 €	11,66 €	

* Soporte incluido en el Kit Doble / Bracket supplied in the Double Kit / Support fourni dans le Double Kit.

Accesorios / Accessories / Accessoires



Soporte
Doble Pared
Double Wall Bracket /
Support mur double

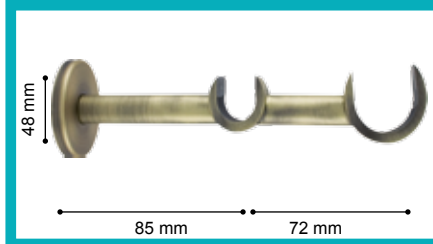

REF	∅				
01387-A4017	30 / 19	10	12,00 €	13,20 €	
01387-B4017	30 / 19	10	12,00 €	13,20 €	
01387-CC4017	30 / 19	10	12,00 €	13,20 €	
01387-CU4017	30 / 19	10	12,00 €	13,20 €	
01387-P4017	30 / 19	10	12,00 €	13,20 €	

* Soporte incluido en el Kit Doble / Bracket supplied in the Double Kit / Support fourni dans le Double Kit.

Soporte
extensible
Extendible
Bracket /
Support
Extensible

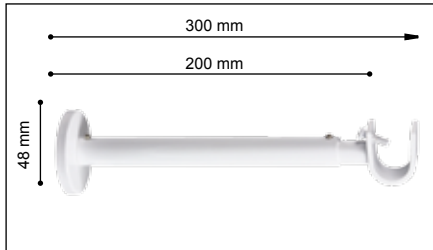

REF	∅				
01386-A4012	19	10	13,78 €	15,16 €	
01386-B4012	19	10	13,78 €	15,16 €	
01386-CC4012	19	10	13,78 €	15,16 €	
01386-CU4012	19	10	13,78 €	15,16 €	
01386-P4012	19	10	13,78 €	15,16 €	

Soporte
extensible
Long Wall
Bracket /
Support
Mur et Plafond



REF	∅				
01387-A4013	30	10	13,78 €	15,16 €	
01387-B4013	30	10	13,78 €	15,16 €	
01387-CC4013	30	10	13,78 €	15,16 €	
01387-CU4013	30	10	13,78 €	15,16 €	
01387-P4013	30	10	13,78 €	15,16 €	

Soporte
Doble Pared
Extensible
Extendible Double
Wall Bracket /
Support mur double
extensible

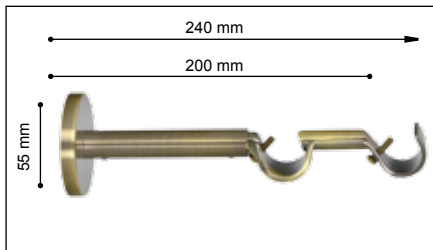

REF	∅				
01386-A4015	19 / 19	10	12,24 €	13,47 €	
01386-B4015	19 / 19	10	12,24 €	13,47 €	
01386-CC4015	19 / 19	10	12,24 €	13,47 €	
01386-CU4015	19 / 19	10	12,24 €	13,47 €	
01386-P4015	19 / 19	10	12,24 €	13,47 €	

Soporte
Doble Pared
Extensible
Extendible Double
Wall Bracket /
Support mur do-
uble extensible

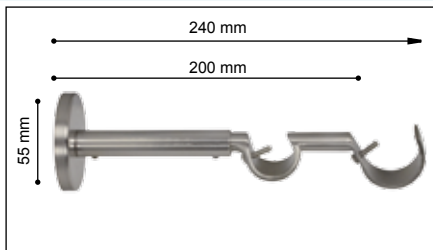

REF	∅				
01387-A4018	30 / 19	10	12,76 €	14,04 €	
01387-B4018	30 / 19	10	12,76 €	14,04 €	
01387-CC4018	30 / 19	10	12,76 €	14,04 €	
01387-CU4018	30 / 19	10	12,76 €	14,04 €	
01387-P4018	30 / 19	10	12,76 €	14,04 €	

Soporte
Pared y Techo
Wall and Ceiling
Bracket /
Support Mur
et Plafond



REF	∅				
01386-A4009	19	10	5,60 €	6,16 €	
01386-B4009	19	10	5,60 €	6,16 €	
01386-CC4009	19	10	5,60 €	6,16 €	
01386-CU4009	19	10	5,60 €	6,16 €	
01386-P4009	19	10	5,60 €	6,16 €	
01387-A4014	30	10	6,50 €	7,15 €	
01387-B4014	30	10	6,50 €	7,15 €	
01387-CC4014	30	10	6,50 €	7,15 €	
01387-CU4014	30	10	6,50 €	7,15 €	
01387-P4014	30	10	6,50 €	7,15 €	

Soporte Refuerzo
Extensible
15 cm - 20 cm

Reinforcing
extendible brackets
15-20cms /
Supports de renfor-
cement extensibles
15-20cms

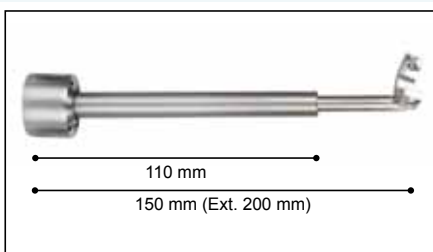

REF	∅				
01386-A502		10	19,38 €	22,29 €	
01386-CC502		10	19,38 €	22,29 €	
01386-CU502		10	19,38 €	22,29 €	
01386-P502		10	19,38 €	22,29 €	

* Compatible con Soportes / Compatible with brackets / Compatible avec supports:

- A.4007A-C-CM-PS
- A.4010A-C-CM-PS
- A.4012A-C-CM-PS
- A.4013A-C-CM-PS
- A.4017A-C-CM-PS

NEW

Accesorios / Accessories / Accessoires

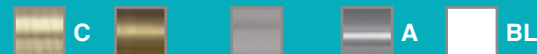

Soporte Lateral

Recess Bracket /
Support
Entre-Murs



REF	∅	U	€	1	cm
01386-A20419	19	10	3,30 €	3,63 €	
01386-B20419	19	10	3,30 €	3,63 €	
01386-CC20419	19	10	3,30 €	3,63 €	
01386-CU20419	19	10	3,30 €	3,63 €	
01386-P20419	19	10	3,30 €	3,63 €	
01387-A20430	30	10	4,90 €	5,39 €	
01387-B20430	30	10	4,90 €	5,39 €	
01387-CC20430	30	10	4,90 €	5,39 €	
01387-CU20430	30	10	4,90 €	5,39 €	
01387-P20430	30	10	4,90 €	5,39 €	

Anillas
sin teflón

Rings
without teflon /
Anneaux
sans teflon

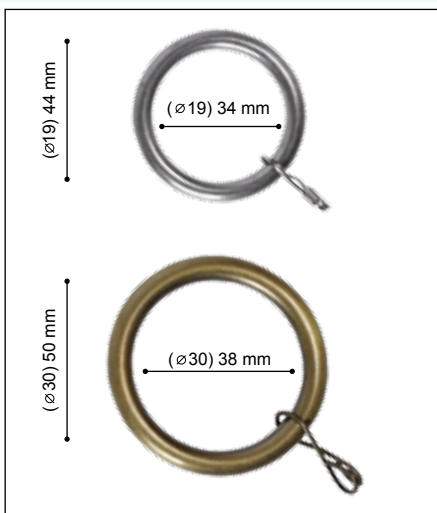

REF	∅	U	€	1	cm
01386-A3002	19	10	0,48 €	10,53 €	
01386-B3002	19	10	0,48 €	10,53 €	
01386-CC3002	19	10	0,48 €	10,53 €	
01386-CU3002	19	10	0,48 €	10,53 €	
01386-P3002	19	10	0,48 €	10,53 €	
01387-A3003	30	10	0,56 €	0,62 €	
01387-B3003	30	10	0,56 €	0,62 €	
01387-CC3003	30	10	0,56 €	0,62 €	
01387-CU3003	30	10	0,56 €	0,62 €	
01387-P3003	30	10	0,56 €	0,62 €	

Anillas
con Teflón

Rings
with teflon /
Anneaux
avec teflon

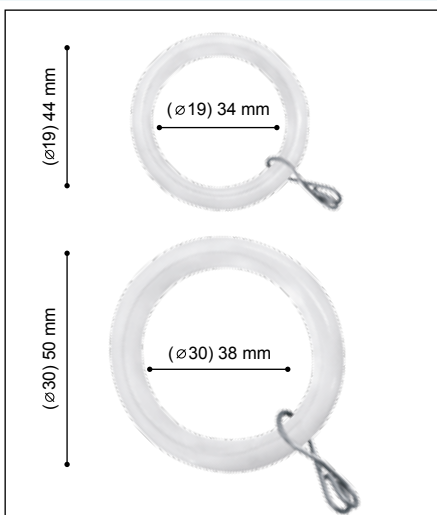

REF	∅	U	€	1	cm
01386-A3004	19	100	0,78 €	0,86 €	
01386-B3004	19	100	0,78 €	0,86 €	
01386-CC3004	19	100	0,78 €	0,86 €	
01386-CU3004	19	100	0,78 €	0,86 €	
01386-P3004	19	100	0,78 €	0,86 €	
01387-A3005	30	100	0,98 €	1,08 €	
01387-B3005	30	100	0,98 €	1,08 €	
01387-CC3005	30	100	0,98 €	1,08 €	
01387-CU3005	30	100	0,98 €	1,08 €	
01387-P3005	30	100	0,98 €	1,08 €	

Anilla Plana
con teflón

Flat Teflon Rings /
Anneaux Plates
avec teflon

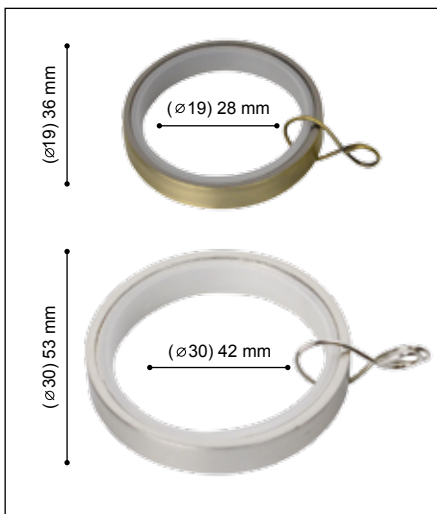

REF	∅	U	€	1	cm
01386-A3006	19	100	0,78 €	0,86 €	
01386-B3006	19	100	0,78 €	0,86 €	
01386-CC3006	19	100	0,78 €	0,86 €	
01386-CU3006	19	100	0,78 €	0,86 €	
01386-P3006	19	100	0,78 €	0,86 €	
01387-A3007	30	100	0,98 €	1,08 €	
01387-B3007	30	100	0,98 €	1,08 €	
01387-CC3007	30	100	0,98 €	1,08 €	
01387-CU3007	30	100	0,98 €	1,08 €	
01387-P3007	30	100	0,98 €	1,08 €	

NEW

Accesorios / Accessories / Accessoires



Barra acero

Pole /
Tube

REF	∅				
01386-A150	19	10	8,95 €	9,85 €	150
01386-A200	19	10	11,85 €	13,04 €	200
01386-A250	19	10	14,83 €	16,32 €	250
01386-A300	19	10	17,77 €	19,55 €	300
01387-A150	30	10	17,04 €	18,75 €	150
01387-A200	30	10	21,35 €	23,49 €	200
01387-A250	30	10	25,56 €	28,12 €	250
01387-A300	30	10	31,95 €	35,15 €	300

Barra cuero
brilloPole /
Tube

REF	∅				
01386-CC150	19	10	8,95 €	9,85 €	150
01386-CC200	19	10	11,85 €	13,04 €	200
01386-CC250	19	10	14,83 €	16,32 €	250
01386-CC300	19	10	17,77 €	19,55 €	300
01387-CC150	30	10	17,04 €	18,75 €	150
01387-CC200	30	10	21,35 €	23,49 €	200
01387-CC250	30	10	25,56 €	28,12 €	250
01387-CC300	30	10	31,95 €	35,15 €	300

Barra cuero
matePole /
Tube

REF	∅				
01386-CU150	19	10	8,95 €	9,85 €	150
01386-CU200	19	10	11,85 €	13,04 €	200
01386-CU250	19	10	14,83 €	16,32 €	250
01386-CU300	19	10	17,77 €	19,55 €	300
01387-CU150	30	10	17,04 €	18,75 €	150
01387-CU200	30	10	21,35 €	23,49 €	200
01387-CU250	30	10	25,56 €	28,12 €	250
01387-CU300	30	10	31,95 €	35,15 €	300

Barra plata
matePole /
Tube

REF	∅				
01386-P150	19	10	8,95 €	9,85 €	150
01386-P200	19	10	11,85 €	13,04 €	200
01386-P250	19	10	14,83 €	16,32 €	250
01386-P300	19	10	17,77 €	19,55 €	300
01387-P150	30	10	17,04 €	18,75 €	150
01387-P200	30	10	21,35 €	23,49 €	200
01387-P250	30	10	25,56 €	28,12 €	250
01387-P300	30	10	31,95 €	35,15 €	300

Barra blanca
Pole /
Tube



REF	∅	U	€	€ ¹	cm
01386-B150	19	10	8,95 €	9,85 €	150
01386-B200	19	10	11,85 €	13,04 €	200
01386-B250	19	10	14,83 €	16,32 €	250
01386-B300	19	10	17,77 €	19,55 €	300
01387-B150	30	10	17,04 €	18,75 €	150
01387-B200	30	10	21,35 €	23,49 €	200
01387-B250	30	10	25,56 €	28,12 €	250
01387-B300	30	10	31,95 €	35,15 €	300

Expositor
VARADERO 1
VARADERO 1
Display Board /
Presentoir
VARADERO 1



	∅	U	€	€ ¹	cm
80386-M207		1		53,0 €	

Expositor
VARADERO 2
VARADERO 12
Display Board /
Presentoir
VARADERO 2



	∅	U	€	€ ¹	cm
80386-N205		1		53,0 €	



ANILLAS CON TEFLÓN

lo natural es no rayarse

Mejoramos la colección Varadero con anillas recubiertas de teflón. Alarga la vida de tus barras de cortina de la forma más natural. Marvent busca soluciones para ti.



- Anillas cubiertas con teflón.
- Sistema anti-rayaduras.
- 5 colores: Cuero Mate, Cuero Brillo, Acero, Plata Mate y Blanco.
- Todas las anillas de **Marvent** tienen ganchos metálicos de gran resistencia.



MARVENT SYSTEM S.L.

Polg. Tecnológico Ogjjares
C/Valladolid, nave 39.3, 18150 Ogjjares
(Granada, España)

Telf: 958 50 38 20
Fax: 958 50 69 18
Email: administracion@marvent.es



Marvent

MARVENT SYSTEM S.L.



nueva
colección



BELMONTE

tu barra de cortina vintage en madera



Barras Clásicas · Portavisillos

classic collections · net curtain rods / collections classiques

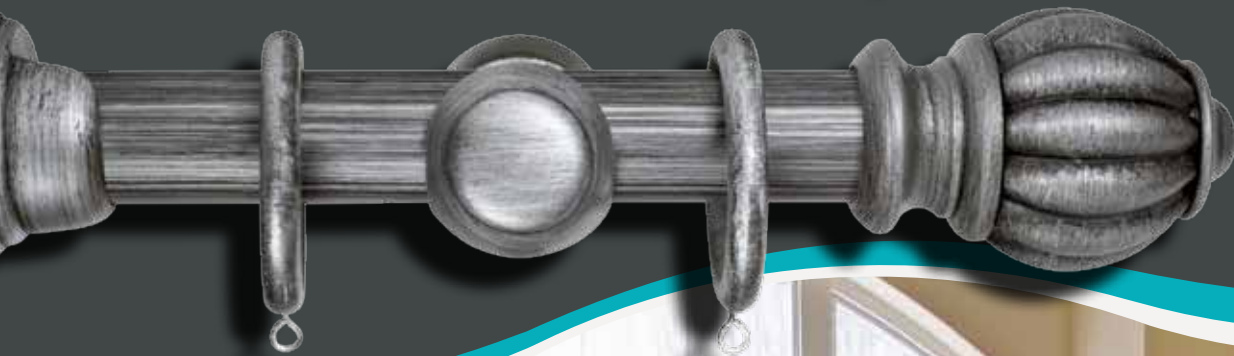

Marvent

SOLUCIONES PARA DECORAR VENTANAS



luxury homes

Duero Collection

barras de cortina • curtain poles • tringles à rideaux

Barra de Cortina DUERO / Curtain Pole DUERO / Tringle a Rideux DUERO



Atlanta Pulido



Atlanta Cuero claro



Atlanta Acero



Reino Pulido



Reino Cuero claro



Reino Acero

La colección Duero está diseñada en latón. En ella se ha puesto la más alta garantía de calidad en su cuidadoso proceso de trabajo, en el acabado de los detalles, en la selección del mejor material y por supuesto en el diseño de sus terminales y soportes que permiten infinidad de soluciones decorativas. Siguiendo un estilo elegante, cálido, brillante con líneas puras y limpias, se convierte en la colección más formal y seria de Altran.

Duero collection is made of brass that is the noblest material for poles. It has been designed and produced with the highest quality process taking special care on the finishing details using high quality materials. The design of its finials and supports allow countless decorative solutions. Following an elegant, warm, bright style with clean lines this collection becomes the more formal and serious collection of Altran.

La collection Duero est fabriqués en laiton qui est le matériel le plus noble pour la fabrication des tringles. Il a été conçu et fabriqué avec le process de fabrication de la plus haute qualité en prenant un soin particulier sur les détails de finition en utilisant des matériaux de haute qualité. La conception de ses embouts et supports permettent d'innombrables solutions décoratives. Cette collection deviant la la collection plus formel et classique d'Altran avec avec son style élégant, chaleureux et lumineux avec lignes pures.

∅ 19 / 30 mm

Barra de Cortina DUERO / Curtain Pole DUERO / Tringle a Rideux DUERO



Londres Pulido



Londres Cuero claro



Londres Acero



Cairo Pulido



Cairo Cuero claro



Cairo Acero

Ø 19 / 30 mm

Barra de Cortina DUERO / Curtain Pole DUERO / Tringle a Rideux DUERO



∅ 19 / 30 mm

DUERO

Conjuntos completos **DUERO** /
Complete sets **DUERO** /
Kits complete **DUERO**

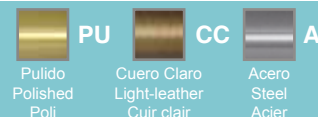

Atlanta



U	Ø 19 REF K.203PU	Ø 30 REF K.213PU	Ø 19/19 REF K.223PU	Ø 30/19 REF K.233PU	Q	cm
1	100,81 €	127,58 €	180,69 €	207,52 €	10	100
1	121,96 €	154,89 €	222,99 €	255,98 €	16	150
1	159,76 €	178,85 €	288,12 €	327,28 €	20	200
1	180,91 €	226,15 €	330,42 €	375,74 €	26	250
1	199,25 €	250,10 €	367,10 €	418,04 €	30	300
1	278,23 €	352,64 €	525,07 €	599,55 €	50	500



U	Ø 19 REF K.203CC	Ø 30 REF K.213CC	Ø 19/19 REF K.223CC	Ø 30/19 REF K.233CC	Q	cm
1	106,49 €	135,01 €	190,49 €	219,05 €	10	100
1	128,06 €	163,02 €	233,63 €	268,64 €	16	150
1	167,83 €	187,68 €	301,92 €	343,41 €	20	200
1	189,41 €	237,27 €	345,07 €	393,00 €	26	250
1	208,17 €	261,92 €	382,61 €	436,43 €	30	300
1	288,86 €	367,26 €	543,97 €	622,45 €	50	500



U	Ø 19 REF K.203A	Ø 30 REF K.213A	Ø 19/19 REF K.223A	Ø 30/19 REF K.233A	Q	cm
1	106,49 €	135,01 €	190,49 €	219,05 €	10	100
1	128,06 €	163,02 €	233,63 €	268,64 €	16	150
1	167,83 €	187,68 €	301,92 €	343,41 €	20	200
1	189,41 €	237,27 €	345,07 €	393,00 €	26	250
1	208,17 €	261,92 €	382,61 €	436,43 €	30	300
1	288,86 €	367,26 €	543,97 €	622,45 €	50	500

Reino



U	Ø 19 REF K.201PU	Ø 30 REF K.211PU	Ø 19/19 REF K.221PU	Ø 30/19 REF K.231PU	Q	cm
1	103,57 €	130,66 €	186,21 €	213,36 €	10	100
1	124,72 €	157,98 €	228,51 €	261,82 €	16	150
1	162,52 €	181,93 €	293,64 €	333,12 €	20	200
1	183,67 €	229,23 €	335,94 €	381,58 €	26	250
1	202,01 €	253,18 €	372,62 €	423,88 €	30	300
1	280,99 €	355,72 €	530,59 €	605,40 €	50	500



U	Ø 19 REF K.201CC	Ø 30 REF K.211CC	Ø 19/19 REF K.221CC	Ø 30/19 REF K.231CC	Q	cm
1	109,48 €	138,41 €	196,47 €	225,45 €	10	100
1	131,05 €	166,43 €	239,61 €	275,03 €	16	150
1	170,82 €	191,08 €	307,90 €	349,81 €	20	200
1	192,40 €	240,67 €	351,05 €	399,40 €	26	250
1	211,16 €	265,33 €	388,59 €	442,82 €	30	300
1	291,85 €	370,67 €	549,95 €	628,84 €	50	500



U	Ø 19 REF K.201A	Ø 30 REF K.211A	Ø 19/19 REF K.221A	Ø 30/19 REF K.231A	Q	cm
1	109,48 €	138,41 €	196,47 €	225,45 €	10	100
1	131,05 €	166,43 €	239,61 €	275,03 €	16	150
1	170,82 €	191,08 €	307,90 €	349,81 €	20	200
1	192,40 €	240,67 €	351,05 €	399,40 €	26	250
1	211,16 €	265,33 €	388,59 €	442,82 €	30	300
1	291,85 €	370,67 €	549,95 €	628,84 €	50	500

Conjuntos completos DUERO /
Complete sets DUERO /
Kits complete DUERO

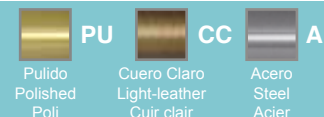

Londres



U	Ø 19 REF K.202PU	Ø 30 REF K.212PU	Ø 19/19 REF K.222PU	Ø 30/19 REF K.232PU	cm	cm
1	104,67 €	127,35 €	188,42 €	211,15 €	10	100
1	125,82 €	154,66 €	230,71 €	259,61 €	16	150
1	163,62 €	178,62 €	295,85 €	330,91 €	20	200
1	184,77 €	225,92 €	338,15 €	379,38 €	26	250
1	203,11 €	249,87 €	374,83 €	421,67 €	30	300
1	282,10 €	352,41 €	532,80 €	603,19 €	50	500



U	Ø 19 REF K.202CC	Ø 30 REF K.212CC	Ø 19/19 REF K.222CC	Ø 30/19 REF K.232CC	cm	cm
1	110,72 €	134,83 €	198,95 €	223,10 €	10	100
1	132,30 €	162,84 €	242,10 €	272,69 €	16	150
1	172,06 €	187,50 €	310,39 €	347,46 €	20	200
1	193,64 €	237,08 €	353,53 €	397,05 €	26	250
1	212,41 €	261,74 €	391,07 €	440,47 €	30	300
1	293,09 €	367,08 €	552,44 €	626,50 €	50	500



U	Ø 19 REF K.202A	Ø 30 REF K.212A	Ø 19/19 REF K.222A	Ø 30/19 REF K.232A	cm	cm
1	110,72 €	134,83 €	198,95 €	223,10 €	10	100
1	132,30 €	162,84 €	242,10 €	272,69 €	16	150
1	172,06 €	187,50 €	310,39 €	347,46 €	20	200
1	193,64 €	237,08 €	353,53 €	397,05 €	26	250
1	212,41 €	261,74 €	391,07 €	440,47 €	30	300
1	293,09 €	367,08 €	552,44 €	626,50 €	50	500

Cairo



U	Ø 19 REF K.204PU	Ø 30 REF K.214PU	Ø 19/19 REF K.224PU	Ø 30/19 REF K.234PU	cm	cm
1	100,81 €	127,58 €	180,69 €	207,52 €	10	100
1	121,96 €	154,89 €	222,99 €	255,98 €	16	150
1	159,76 €	178,85 €	288,12 €	327,28 €	20	200
1	180,91 €	226,15 €	330,42 €	375,74 €	26	250
1	199,25 €	250,10 €	367,10 €	418,04 €	30	300
1	278,23 €	352,64 €	525,07 €	599,55 €	50	500



U	Ø 19 REF K.204CC	Ø 30 REF K.214CC	Ø 19/19 REF K.224CC	Ø 30/19 REF K.234CC	cm	cm
1	106,49 €	135,01 €	190,49 €	219,05 €	10	100
1	128,06 €	163,02 €	233,63 €	268,64 €	16	150
1	167,83 €	187,68 €	301,92 €	343,41 €	20	200
1	189,41 €	237,27 €	345,07 €	393,00 €	26	250
1	208,17 €	261,92 €	382,61 €	436,43 €	30	300
1	288,86 €	367,26 €	543,97 €	622,45 €	50	500



U	Ø 19 REF K.204A	Ø 30 REF K.214A	Ø 19/19 REF K.224A	Ø 30/19 REF K.234A	cm	cm
1	106,49 €	135,01 €	190,49 €	219,05 €	10	100
1	128,06 €	163,02 €	233,63 €	268,64 €	16	150
1	167,83 €	187,68 €	301,92 €	343,41 €	20	200
1	189,41 €	237,27 €	345,07 €	393,00 €	26	250
1	208,17 €	261,92 €	382,61 €	436,43 €	30	300
1	288,86 €	367,26 €	543,97 €	622,45 €	50	500

DUERO

Conjuntos completos **DUERO** /
Complete sets **DUERO** /
Kits complete **DUERO**



Topo



U	Ø 19 REF K.205PU	Ø 30 REF K.215PU	Ø 19/19 REF K.225PU	Ø 30/19 REF K.235PU	Q	cm
1	92,07 €	112,03 €	163,21 €	183,23 €	10	100
1	113,22 €	139,35 €	205,51 €	231,69 €	16	150
1	151,02 €	163,30 €	270,64 €	302,99 €	20	200
1	172,17 €	210,60 €	312,94 €	351,45 €	26	250
1	190,51 €	234,55 €	349,62 €	393,75 €	30	300
1	269,49 €	337,09 €	507,59 €	575,27 €	50	500



U	Ø 19 REF K.205CC	Ø 30 REF K.215CC	Ø 19/19 REF K.225CC	Ø 30/19 REF K.235CC	Q	cm
1	97,06 €	117,71 €	171,63 €	192,33 €	10	100
1	118,63 €	145,73 €	214,77 €	241,91 €	16	150
1	158,40 €	170,38 €	283,06 €	316,69 €	20	200
1	179,98 €	219,97 €	326,21 €	366,28 €	26	250
1	198,74 €	244,63 €	363,75 €	409,70 €	30	300
1	279,43 €	349,97 €	525,11 €	595,72 €	50	500



U	Ø 19 REF K.205A	Ø 30 REF K.215A	Ø 19/19 REF K.225A	Ø 30/19 REF K.235A	Q	cm
1	97,06 €	117,71 €	171,63 €	192,33 €	10	100
1	118,63 €	145,73 €	214,77 €	241,91 €	16	150
1	158,40 €	170,38 €	283,06 €	316,69 €	20	200
1	179,98 €	219,97 €	326,21 €	366,28 €	26	250
1	198,74 €	244,63 €	363,75 €	409,70 €	30	300
1	279,43 €	349,97 €	525,11 €	595,72 €	50	500

Piña



U	Ø 19 REF K.208PA	Ø 30 REF K.218PA	Ø 19/19 REF K.228PA	Ø 30/19 REF K.238PA	Q	cm
1	114,06 €	142,26 €	207,18 €	235,44 €	10	100
1	135,76 €	170,44 €	250,59 €	285,32 €	16	150
1	174,11 €	195,27 €	316,83 €	358,05 €	20	200
1	195,81 €	243,44 €	360,23 €	407,94 €	26	250
1	214,71 €	268,27 €	398,02 €	451,66 €	30	300
1	295,90 €	374,30 €	560,40 €	638,88 €	50	500

Verona



U	Ø 19 REF K.206PA	Ø 30 REF K.216PA	Ø 19/19 REF K.226PA	Ø 30/19 REF K.236PA	Q	cm
1	110,15 €	137,84 €	199,36 €	227,11 €	10	100
1	131,85 €	166,03 €	242,77 €	277,00 €	16	150
1	170,20 €	190,85 €	309,01 €	349,73 €	20	200
1	191,90 €	239,03 €	352,41 €	399,62 €	26	250
1	210,80 €	263,86 €	390,20 €	443,34 €	30	300
1	291,99 €	369,89 €	552,58 €	630,56 €	50	500

Sevilla



U	Ø 19 REF K.207PA	Ø 30 REF K.217PA	Ø 19/19 REF K.227PA	Ø 30/19 REF K.237PA	Q	cm
1	94,69 €	136,78 €	168,45 €	210,60 €	10	100
1	116,39 €	164,97 €	211,85 €	260,48 €	16	150
1	154,74 €	189,80 €	278,09 €	333,21 €	20	200
1	176,44 €	237,97 €	321,49 €	383,10 €	26	250
1	195,34 €	262,80 €	359,28 €	426,82 €	30	300
1	276,53 €	368,83 €	521,66 €	614,04 €	50	500

Conjuntos completos **DUERO** /
Complete sets **DUERO** /
Kits complete **DUERO**



Chile



U	Ø 19	Ø 30 REF K.219PA	Ø 19/19	Ø 30/19 REF K.239PA	cm
1	-	128,73 €	-	202,55 €	10
1	-	156,92 €	-	252,43 €	16
1	-	181,75 €	-	325,16 €	20
1	-	229,92 €	-	375,05 €	26
1	-	254,75 €	-	418,77 €	30
1	-	360,78 €	-	605,99 €	50

Contenido del Kit / Kit components / Composants du Kit

- Barra de 19 mm: 2 terminales, soportes 2 < 150 > 3, barra y anillas.
- Barra de 30 mm: 2 terminales, soportes 2 < 200 > 3, barra y anillas.
- Barras dobles: 4 terminales, soportes 2 < 150 > 3, barra y anillas.

*Las barras dobles se sirven con terminal tapón trasero.

Terminales / Finials / Embouts



Reino



REF	Ø	U	€	€	cm
04119-PU32119	19	10	10,94 €	12,58 €	
04119-CC32119	19	10	11,80 €	13,57 €	
04119-A32119	19	10	11,80 €	13,57 €	
04130-PU32130	30	10	17,14 €	19,71 €	
04130-CC32130	30	10	18,52 €	21,30 €	
04130-A32130	30	10	18,52 €	21,30 €	

Londres



REF	Ø	U	€	€	cm
04119-PU32219	19	10	11,42 €	13,13 €	
04119-CC32219	19	10	12,34 €	14,19 €	
04119-A32219	19	10	12,34 €	14,19 €	
04130-PU32230	30	10	15,70 €	18,06 €	
04130-CC32230	30	10	16,96 €	19,50 €	
04130-A32230	30	10	16,96 €	19,50 €	

Atlanta



REF	Ø	U	€	€	cm
04119-PU32319	19	10	9,74 €	11,20 €	
04119-CC32319	19	10	10,50 €	12,08 €	
04119-A32319	19	10	10,50 €	12,08 €	
04130-PU32330	30	10	15,80 €	18,17 €	
04130-CC32330	30	10	17,04 €	19,60 €	
04130-A32330	30	10	17,04 €	19,60 €	

Cairo

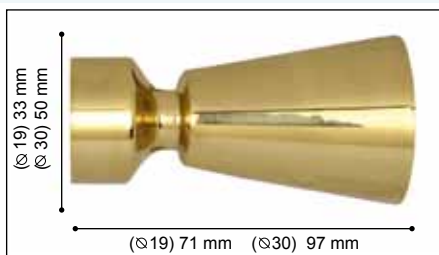

REF	Ø	U	€	€	cm
04119-PU32419	19	10	9,74 €	11,20 €	
04119-CC32419	19	10	10,50 €	12,08 €	
04119-A32419	19	10	10,50 €	12,08 €	
04130-PU32430	30	10	15,80 €	18,17 €	
04130-CC32430	30	10	17,04 €	19,60 €	
04130-A32430	30	10	17,04 €	19,60 €	

Tope



REF	Ø	U	€	€	cm
04119-PU32519	19	10	5,94 €	6,83 €	
04119-CC32519	19	10	6,40 €	7,36 €	
04119-A32519	19	10	6,40 €	7,36 €	
04130-PU32530	30	10	9,04 €	10,40 €	
04130-CC32530	30	10	9,52 €	10,95 €	
04130-A32530	30	10	9,52 €	10,95 €	

Terminales / Finials / Embouts



Verona



REF	Ø	U	€	€	cm
04119-PA32619	19	10	13,32 €	15,32 €	
04130-PA32630	30	10	19,50 €	22,43 €	

Sevilla

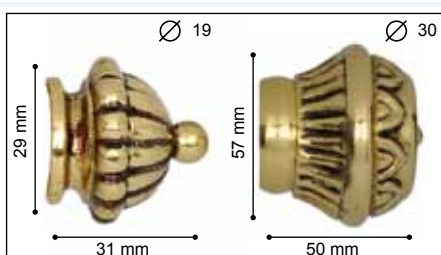

REF	Ø	U	€	€	cm
04119-PA32719	19	10	6,60 €	7,59 €	
04130-PA32730	30	10	19,04 €	21,90 €	

Piña



REF	Ø	U	€	€	cm
04119-PA32819	19	10	15,02 €	17,27 €	
04130-PA32830	30	10	21,42 €	24,63 €	

Chile



REF	Ø	U	€	€	cm
04130-PA30029	30	10	15,54 €	17,87 €	

Accesorios / Accessories / Accessoires

Pulido
(Materia: Latón)

Gold Polished
(Material: Brass) /
Doré
(Matériel: Laiton)



REF	Ø	U	€	€	cm
04116-PU10216	16	25 m	19,98 €/m	22,98 €/m	
04119-PU10219	19	25 m	22,14 €/m	25,46 €/m	
04130-PU10230	30	25 m	29,98 €/m	34,48 €/m	

Cuero Claro
(Materia: Latón)

Light Leather
(Material: Brass) /
Cuir Clair
(Matériel: Laiton)



REF	Ø	U	€	€	cm
04119-CC10219	19	25 m	22,88 €/m	26,31 €/m	
04130-CC10230	30	25 m	31,20 €/m	35,88 €/m	

Acero (Material:
Acero Inoxidable)

Steel (Material:
stainless steel) /
Acier (Matériel:
acier inoxydable)



REF	Ø	U	€	€	cm
04119-A10219	19	25 m	22,88 €/m	26,31 €/m	
04130-A10230	30	25 m	31,20 €/m	35,88 €/m	

Pátina
(Materia: Latón)

Antique fluted
(Material:
stainless steel) /
Antique striée
(Matériel:
acier inoxydable)



REF	∅	U	€	€ ¹	cm
04119-PA10119	19	25 m	23,10 €/m	26,57 €/m	
04130-PA10130	30	25 m	31,50 €/m	36,23 €/m	

Soporte frente

Bracket Wall /
Support mur

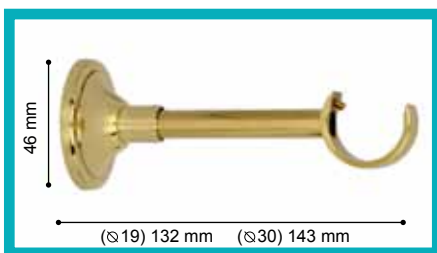

REF	∅	U	€	€ ¹	cm
04119-PU50019	19	10	16,92 €	19,46 €	
04119-CC50019	19	10	18,26 €	21,00 €	
04119-A50019	19	10	18,26 €	21,00 €	
04130-PU50030	30	10	17,38 €	19,99 €	
04130-CC50030	30	10	18,76 €	21,57 €	
04130-A50030	30	10	18,76 €	21,57 €	

* Soporte incluido en el Kit Sencillo /
Bracket supplied in the Single Kit / Support fourni dans le Simple Kit.

Soporte Largo

Bracket Wall Long /
Support mur largo



REF	∅	U	€	€ ¹	cm
04119-PU50219	19	10	18,08 €	20,79 €	
04119-CC50219	19	10	19,50 €	22,43 €	
04119-A50219	19	10	19,50 €	22,43 €	
04130-PU50230	30	10	19,50 €	22,43 €	
04130-CC50230	30	10	21,08 €	24,24 €	
04130-A50230	30	10	21,08 €	24,24 €	

Soporte Techo

Bracket Ceiling /
Support Plafond



REF	∅	U	€	€ ¹	cm
04119-PU50119	19	10	17,62 €	20,26 €	
04119-CC50119	19	10	19,84 €	22,82 €	
04119-A50119	19	10	19,84 €	22,82 €	
04130-PU50130	30	10	20,80 €	23,92 €	
04130-CC50130	30	10	22,46 €	25,83 €	
04130-A50130	30	10	22,46 €	25,83 €	

Soporte frente doble

Bracket
Wall Double /
Support
Mur Double

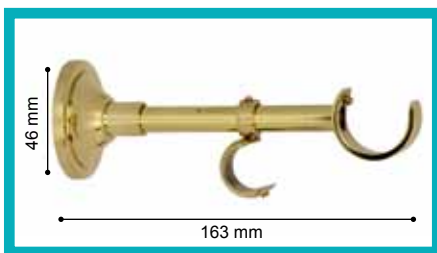

REF	∅	U	€	€ ¹	cm
04119-PU51119	19/19	10	24,74 €	28,45 €	
04119-CC51119	19/19	10	26,74 €	30,75 €	
04119-A51119	19/19	10	26,74 €	30,75 €	
04130-PU51319	30/19	10	25,224 €	29,01 €	
04130-CC51319	30/19	10	27,26 €	31,35 €	
04130-A51319	30/19	10	27,26 €	31,35 €	

* Soporte incluido en el Kit Doble /
Bracket supplied in the Double Kit / Support fourni dans le Double Kit.

Soporte Auxiliar para Barras

Curtain Pole
Auxiliary Bracket /
Support
complémentaire



REF	∅	U	€	€ ¹	cm
V.19PU	19	10	8,48 €	9,75 €	
V.19CC	19	10	8,56 €	9,84 €	
V.19A	19	10	8,56 €	9,84 €	

NEW

Terminales / Finials / Embouts



		REF	∅				
Soporte Techo Doble Bracket Ceiling Double / Support Plafond Double	 56 mm (∅19) 67 mm (∅30) 73 mm (∅19) 110 mm (∅30) 118 mm	04119-PU52119	19/19	10	24,74 €	28,45 €	
		04119-CC52119	19/19	10	26,74 €	30,75 €	
		04119-A52119	19/19	10	26,74 €	30,75 €	
		04130-PU52319	30/19	10	25,22 €	29,00 €	
		04130-CC52319	30/19	10	27,26 €	31,35 €	
		04130-A52319	30/19	10	27,26 €	31,35 €	
Soporte Refuerzo Extensible 15 cm - 20 cm Reinforcing extendible brackets 15-20cms / Supports de renforcement extensibles 15-20cms	 110 mm 150 mm (Ext. 200 mm)	04119-PU502		10	19,38 €	22,29 €	
		01386-CC502		10	19,38 €	22,29 €	
		01386-A502		10	19,38 €	22,29 €	
		* Compatible con Soportes / Compatible with brackets / Compatible avec supports: • N.50019PU • N.50019CC • N.50019A • N.50030PU • N.50030CC • N.50030A • O.51119PU • O.51119CC • O.51119A • O.51130PU • O.51130CC • O.51130A					
Soporte Dintel Recess bracket / Support entremurs	 (∅19) 29 mm (∅30) 39 mm (∅19) 17 mm (∅30) 20 mm	04119-PU50419	19	10	8,34 €	9,59 €	
		04119-CC50419	19	10	9,00 €	10,35 €	
		04119-A50419	19	10	9,00 €	10,35 €	
		04130-PU50430	30	10	11,42 €	13,13 €	
		04130-CC50430	30	10	12,34 €	14,19 €	
		04130-A50430	30	10	12,34 €	14,19 €	
Codo Articulado Articulsted Elbow / Coude articulé	 (∅19) 70 mm (∅30) 108 mm	H.519PU	19	10	17,86 €	20,54 €	
		H.519CC	19	10	19,30 €	22,20 €	
		H.519A	19	10	19,30 €	22,20 €	
		H.530PU	30	10	24,26 €	27,90 €	
		H.530CC	30	10	26,22 €	30,15 €	
		H.530A	30	10	26,22 €	30,15 €	
Rosetón Perlas Rosette / Rosace	 60 mm	04332-PU1181		10	5,02 €	5,77 €	60
		04332-CC1181		10	5,46 €	6,28 €	60
		04332-A1181		10	5,46 €	6,28 €	60
		04332-PA1181		10	5,28 €	6,07 €	60
Rosetón Liso Rosette / Rosace	 60 mm	04332-PU1157		10	4,58 €	5,27 €	60
		04332-CC1157		10	4,88 €	5,61 €	60
		04332-A1157		10	4,88 €	5,61 €	60
Rosetón Italiano Rosette / Rosace	 60 mm	04332-PA1147		10	6,18 €	7,11 €	60
Prolongador Spindle / Prolongateur	 100 / 150 mm	04332-PU1166		10	4,36 €	5,01 €	100
		04332-CC1166		10	4,72 €	5,43 €	100
		04332-A1166		10	4,72 €	5,43 €	100
		04332-PU1167		10	5,98 €	6,88 €	150
		04332-CC1167		10	6,44 €	7,41 €	150
		04332-A1167		10	6,44 €	7,41 €	150

NEW

Accesorios / Accessories / Accessoires



Abrazadera
Holder /
Embrasse

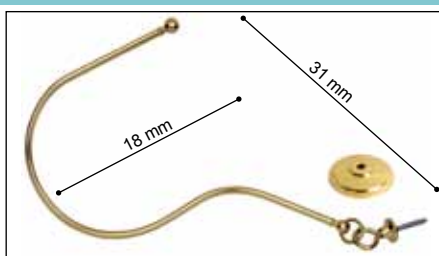

REF	∅	U	€	€	cm
04332-PU1220		10	29,22 €	33,60 €	
04332-CC1220		10	31,56 €	36,29 €	
04332-A1220		10	31,56 €	36,29 €	

Anillas con teflón
Rings with teflon /
Anneaux avec teflon



REF	∅	U	€	€	cm
04119-PU20019	19	50	1,22 €	1,40 €	
04119-CC20019	19	50	1,22 €	1,40 €	
04119-A20019	19	50	1,22 €	1,40 €	
04130-PU20030	30	50	1,46 €	1,68 €	
04130-CC20030	30	50	1,46 €	1,68 €	
04130-A20030	30	50	1,46 €	1,68 €	

Gancho
Hook /
Gond



REF	∅	U	€	€	cm
R.1001LA		50	1,68 €	1,93 €	
R.1001AB		50	1,68 €	1,93 €	
01375-PB1001		50	1,68 €	1,93 €	
01375-PM1001		50	1,68 €	1,93 €	
R.1001BL		50	1,46 €	1,68 €	
R.1002LA		50	1,82 €	2,09 €	
01375-CU1002		50	1,82 €	2,09 €	
01375-PB1002		50	1,82 €	2,09 €	
01375-PM1002		50	1,82 €	2,09 €	
01375-B1002		50	1,60 €	1,84 €	

Tirador
Wand /
Bâiton



REF	∅	U	€	€	cm
L.3100PU		1		23,58 €	100
L.3100CC		1		25,52 €	100
L.3100A		1		25,52 €	100

Expositor
DUERO

DUERO
Display Board /
Presentoir DUERO



REF	∅	U	€	€	cm
M.210		1		116,80 €	



Cortinas técnicas verticales



ESCALERA Ø 16

Conjunto Completo ESCALERA /
Complete sets STAIRCASE /
Kits complets pour ESCALIER

PU
Pulido
Polished
Poli

Escalera / Staircase / Escalier



REF	Ø			
K.101100PU	16	1	58,58 €	100
K.101150PU	16	1	70,07 €	150

Accesorios / Accessories / Accessoires

PU

Soporte

Bracket /
Support



REF	Ø				
04116-PU50117		25	9,08 €	10,44 €	

* Soporte incluido en el kit / Bracket supplied in the kit / Support fourni dans le kit.

Barra lisa

Brass Pole /
Barre laiton



REF	Ø				
04160-PU10216		25 m	19,98 €/m	22,98 €/m	

Piña latón

Solid brass finials /
Embouts en laiton
massif



REF	Ø				
04116-PU30716		25	6,40 €	7,36 €	



Accesorios para MUSEO /
MUSEUM Cords Accessories /
Accessoires de Cordon pour MUSÉE



Peana de latón pulido 1m. / Solid brass barrier rope stand 1m. Goldpolished / Potelet Laiton massif 1m. or poli

Peana de 1m
latón pulido

Solid brass barrier
rope stand 1m Gold
polished /
Potelet Laiton
massif 1m or poli



REF	∅	U	€	€	cm
R.19PU		1		204,42 €	100

Terminal con anilla
latón

Solid Brass Endcap
with ring /
Terminaison avec
anneau laiton massif



REF	∅	U	€	€	cm
04332-PU1173		10	13,80 €	15,87 €	

* Soporte incluido en el kit / Bracket supplied in the kit / Support fourni dans le kit.

Gancho latón

Solid brass Hook /
Gond en laiton massif



REF	∅	U	€	€	cm
04332-PU1172		10	9,18 €	10,56 €	

Cordón

Staircase /
Barrier



REF	∅	U	€	€	cm
04332-C1701		12 m	17,80 €	20,47 €/m	100
04332-O1703		12 m	17,80 €	20,47 €/m	100
04332-GR1708		25 m	17,80 €	20,47 €/m	100

D.1701 - Crudo / Canvas Colour / Couleur Écru.

D.1703 - Oro / Gold / Or

D.1708 - Granate / Burgundy / Bordeaux

Solutions for:
MUSEUM & EVENTS

A Specialist for Specialists!!!

Logos: R+T, heimtextil, EVTEKS, VETEBCO

FORJA WROUGHT IRON



Marvent
SOLUCIONES PARA DECORAR VENTANAS



Coliseum



Gajos

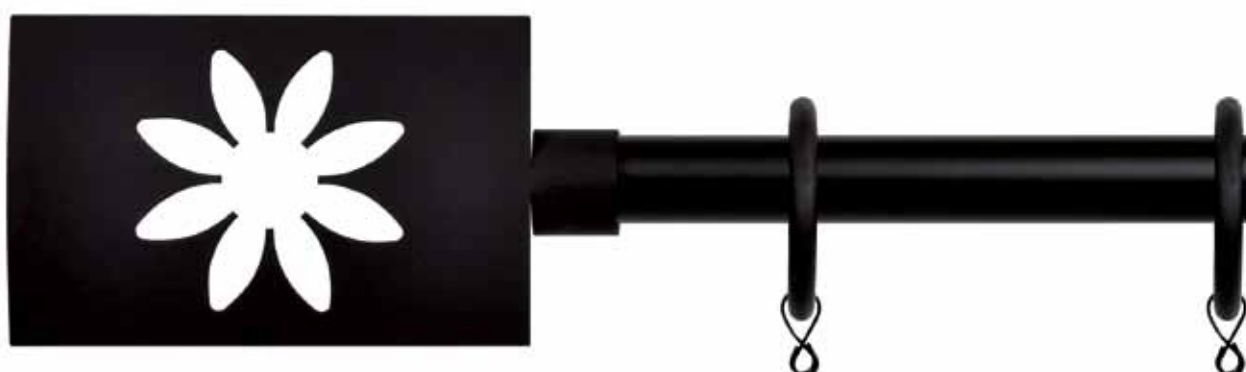

Estrella Plana



Onda Plana

Las colecciones de hierro forjado han estado siempre presentes en el mercado. Ahora es el momento de modernizarlas, empleando infinidad de soportes que cubren múltiples ambientes. Además su riqueza en terminales, permite numerosas combinaciones acordes a la decoración de cualquier habitación en estilo rústico.

Wrought iron collections have always been present in the market. Now is the time to modernize it including different option for supports for all kind of ambients. Besides its range of finials, provided numerous combinations that match the decoration of any room in rustic style.

Les collections en fer forgé ont toujours été présents sur le marché. Il est maintenant temps de le moderniser avec les options différents de supports pour toutes sortes de environnements. Outre sa gamme d'embouts offres de nombreuses combinaisons pour la décoration avec un style rustique.

Barra de Cortina FORJA / WROUGHT IRON Curtain Pole / Tringle a Rideux FER FORGÉ



Bola Negro



Tope Marfil - Oro



Terra Negro - Oro



Feria Negro - Óxido

Ø 19 / 30 mm



Báculo Negro



Palmera Marfil - Oro



Trenza Negro - Oro



Flor de Lys Negro - Óxido

Ø 19 / 30 mm

FORJA

Conjuntos completos sin terminales FORJA /
Complete sets excluding finials WROUGHT IRON /
Kits complete sans embouts FER FORGÉ

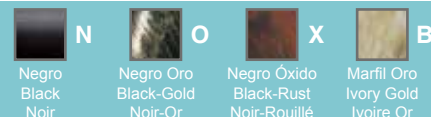

Ø 19 mm



U	Ø 19 REF K.1801	Ø 30	Ø 19/19 REF K.1802	Ø 30/19	cm
1	29,53 €		51,24 €		10
1	37,21 €		66,61 €		16
1	43,33 €		78,84 €		20
1	58,88 €		106,03 €		26
1	65,00 €		118,27 €		30
1	72,68 €		133,63 €		36
1	78,80 €		145,87 €		40



U	Ø 19 REF K.1801	Ø 30	Ø 19/19 REF K.1802	Ø 30/19	cm
1	35,51 €		61,59 €		10
1	44,76 €		80,09 €		16
1	52,12 €		94,81 €		20
1	70,82 €		127,49 €		26
1	78,18 €		142,21 €		30
1	87,42 €		160,70 €		36
1	94,78 €		175,42 €		40

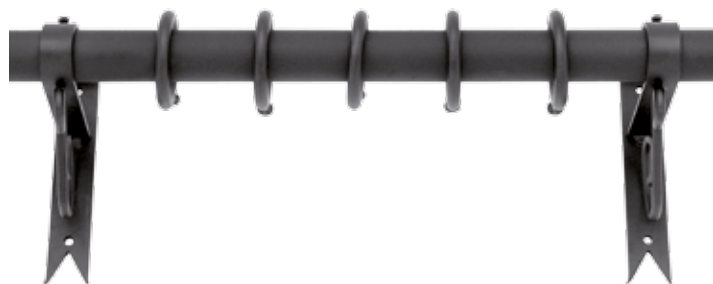

Ø 30 mm







U	Ø 19	Ø 30 REF K.1805	Ø 19/19	Ø 30/19 REF K.1806	cm
1		42,14 €		60,08 €	10
1		53,91 €		79,53 €	16
1		63,30 €		95,04 €	20
1		85,56 €		127,05 €	26
1		94,94 €		142,55 €	30
1		106,72 €		162,01 €	36
1		116,10 €		177,51 €	40
1		158,42 €		-	60



U	Ø 19	Ø 30 REF K.1805	Ø 19/19	Ø 30/19 REF K.1806	cm
1		49,96 €		71,53 €	10
1		63,78 €		94,60 €	16
1		74,75 €		112,93 €	20
1		101,15 €		151,06 €	26
1		112,13 €		169,40 €	30
1		125,95 €		192,46 €	36
1		136,92 €		210,80 €	40
1		184,44 €		-	60

 Los conjuntos de medida superior a 2 m se sirven con 3 soportes.
 Los conjuntos de más de 3 metros se sirven empalmados.
 Conjuntos Sencillos: 2 terminales, 2 soportes, barra y anillas de acero.
 Conjuntos Dobles*: 4 term., 2 sop.dobles, 2 barras y anillas.
 Conjunto Dobles: Se sirven con el mismo terminal para ambas barras.

 All sets with a length longer than 2 meters are supplied with 3 brackets.
 Sets of more than 3 mts. are supplied in 2 halves and splice.
 Single Sets: 2 finials, 2 brackets, pole & steel rings.
 Double Sets*: 4 finials, 2 double brackets, 2 poles & steel rings.
 Double Sets: The Double Sets are supplied with the same finials in both poles.

 Tous les kits de mesures supérieures à 2 mètres contiennent 3 supports.
 Les sets de plus de 3 mts. sont fournis en 2 morceaux avec raccord.
 Kits Simples: 2 embouts, 2 supports, tube et anneaux acier.
 Kits Doubles*: 4 embouts, 2 supports doubles, 2 tubes et anneaux acier.
 Kits Doubles: Sont fournis avec les mêmes embouts pour les deux tringles.

Terminales / Finials / Embouts



Bola

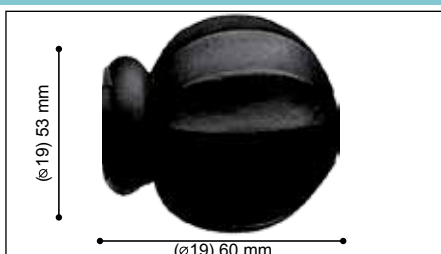

REF	∅				
02369-NBO	19	10	5,76 €	6,62 €	
02369-OBO	19	10	6,90 €	7,94 €	
02369-XBO	19	10	6,90 €	7,94 €	
02369-BBO	19	10	6,90 €	7,94 €	

Coliseum



REF	∅				
02369-N219	19	10	6,94€	7,98 €	
02369-O219	19	10	8,32 €	9,57 €	
02369-X219	19	10	8,32 €	9,57 €	
02369-B219	19	10	8,32 €	9,57 €	
02368-N230	30	10	11,56 €	13,29 €	
02368-O230	30	10	13,88 €	15,96 €	
02368-X230	30	10	13,88 €	15,96 €	
02368-B230	30	10	13,88 €	15,96 €	

Gajos



REF	∅				
02369-N319	19	10	7,60 €	8,74 €	
02369-O319	19	10	9,12 €	10,49 €	
02369-X319	19	10	9,12 €	10,49 €	
02369-B319	19	10	9,12 €	10,49 €	
02368-N330	30	10	12,82 €	14,74 €	
02368-O330	30	10	15,38 €	17,69 €	
02368-X330	30	10	15,38 €	17,69 €	
02368-B330	30	10	15,38 €	17,69 €	

Terminales / Finials / Embouts



Estrella Plana

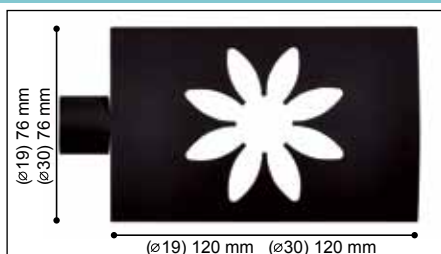

REF	∅				
02369-N619	19	10	5,62 €	6,46 €	
02369-O619	19	10	6,74 €	7,75 €	
02369-X619	19	10	6,74 €	7,75 €	
02369-B619	19	10	6,74 €	7,75 €	
02368-N630	30	1	-	9,71 €	
02368-O630	30	1	-	11,64 €	
02368-X630	30	1	-	11,64 €	
02368-B630	30	1	-	11,64 €	

*El terminal de Ø19 emplea un adaptador para convertirse en Ø30. Adaptador incluido en el precio. /
The 30mm finials comprise the finial used for 19mm and one adapter to that purpose included in the price. /
Les embouts de 30mm comprennent l'embout utilisé pour 19mm et un adaptateur à cette fin inclus dans le prix.

Onda Plana

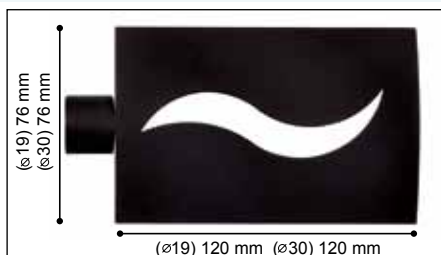

REF	∅				
02369-N719	19	10	5,62 €	6,46 €	
02369-O719	19	10	6,74 €	7,75 €	
02369-X719	19	10	6,74 €	7,75 €	
02369-B719	19	10	6,74 €	7,75 €	
02368-N730	30	1	-	9,71 €	
02368-O730	30	1	-	11,64 €	
02368-X730	30	1	-	11,64 €	
02368-B730	30	1	-	11,64 €	

*El terminal de Ø19 emplea un adaptador para convertirse en Ø30. Adaptador incluido en el precio. /
The 30mm finials comprise the finial used for 19mm and one adapter to that purpose included in the price. /
Les embouts de 30mm comprennent l'embout utilisé pour 19mm et un adaptateur à cette fin inclus dans le prix.

Tope



REF	∅				
02369-NTO	19	10	5,20 €	5,98 €	
02369-OTO	19	10	6,24 €	7,18 €	
02369-XTO	19	10	6,24 €	7,18 €	
02369-BTO	19	10	6,24 €	7,18 €	
02368-NTO	30	10	4,46 €	5,13 €	
02368-OTO	30	10	5,38 €	6,19 €	
02368-XTO	30	10	5,38 €	6,19 €	
02368-BTO	30	10	5,38 €	6,19 €	

Terra



REF	∅				
02369-NRR	19	10	7,50 €	8,63 €	
02369-ORR	19	10	9,02 €	10,37 €	
02369-XRR	19	10	9,02 €	10,37 €	
02369-BRR	19	10	9,02 €	10,37 €	
02368-NRR	30	1	-	11,87 €	
02368-ORR	30	1	-	14,26 €	
02368-XRR	30	1	-	14,26 €	
02368-BRR	30	1	-	14,26 €	

*El terminal de Ø19 emplea un adaptador para convertirse en Ø30. Adaptador incluido en el precio. /
The 30mm finials comprise the finial used for 19mm and one adapter to that purpose included in the price. /
Les embouts de 30mm comprennent l'embout utilisé pour 19mm et un adaptateur à cette fin inclus dans le prix.

Feria

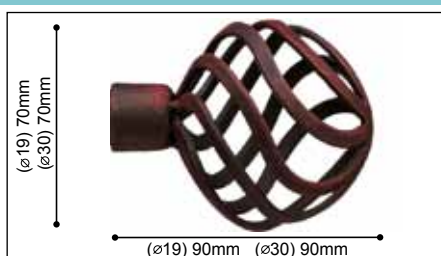

REF	∅	U	€	1	cm
02369-NFR	19	10	7,92 €	9,11 €	
02369-OFR	19	10	9,48 €	10,90 €	
02369-XFR	19	10	9,48 €	10,90 €	
02369-BFR	19	10	9,48 €	10,90 €	
02368-NFR	30	1	-	12,35 €	
02368-OFR	30	1	-	14,79 €	
02368-XFR	30	1	-	14,79 €	
02368-BFR	30	1	-	14,79 €	

*El terminal de ∅19 emplea un adaptador para convertirse en ∅30. Adaptador incluido en el precio. / The 30mm finials comprise the finial used for 19mm and one adapter to that purpose included in the price. / Les embouts de 30mm comprennent l'embout utilisé pour 19mm et un adaptateur à cette fin inclus dans le prix.

Báculo



REF	∅	U	€	1	cm
02369-NBA	19	10	7,06 €	8,12 €	
02369-OBA	19	10	8,46 €	9,73 €	
02369-XBA	19	10	8,46 €	9,73 €	
02369-BBA	19	10	8,46 €	9,73 €	
02368-NBA	30	1	-	11,36 €	
02368-OBA	30	1	-	13,62 €	
02368-XBA	30	1	-	13,62 €	
02368-BBA	30	1	-	13,62 €	

*El terminal de ∅19 emplea un adaptador para convertirse en ∅30. Adaptador incluido en el precio. / The 30mm finials comprise the finial used for 19mm and one adapter to that purpose included in the price. / Les embouts de 30mm comprennent l'embout utilisé pour 19mm et un adaptateur à cette fin inclus dans le prix.

Palmera

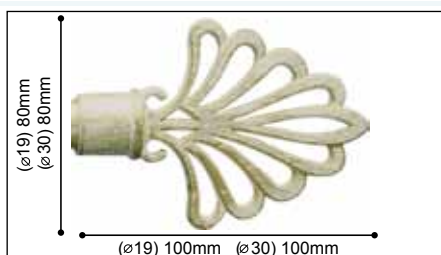

REF	∅	U	€	1	cm
02369-NP	19	10	5,26 €	6,05 €	
02369-OP	19	10	6,30 €	7,25 €	
02369-XP	19	10	6,30 €	7,25 €	
02369-BP	19	10	6,30 €	7,25 €	
02368-NP	30	1	-	9,29 €	
02368-OP	30	1	-	11,13 €	
02368-XP	30	1	-	11,13 €	
02368-BP	30	1	-	11,13 €	

*El terminal de ∅19 emplea un adaptador para convertirse en ∅30. Adaptador incluido en el precio. / The 30mm finials comprise the finial used for 19mm and one adapter to that purpose included in the price. / Les embouts de 30mm comprennent l'embout utilisé pour 19mm et un adaptateur à cette fin inclus dans le prix.

Trenza



REF	∅	U	€	1	cm
02369-NT	19	10	11,44 €	13,16 €	
02369-OT	19	10	13,72 €	15,78 €	
02369-XT	19	10	13,72 €	15,78 €	
02369-BT	19	10	13,72 €	15,78 €	
02368-NT	30	1	-	16,40 €	
02368-OT	30	1	-	19,67 €	
02368-XT	30	1	-	19,67 €	
02368-BT	30	1	-	19,67 €	

*El terminal de ∅19 emplea un adaptador para convertirse en ∅30. Adaptador incluido en el precio. / The 30mm finials comprise the finial used for 19mm and one adapter to that purpose included in the price. / Les embouts de 30mm comprennent l'embout utilisé pour 19mm et un adaptateur à cette fin inclus dans le prix.

Terminales / Finials / Embouts



Flor de Lys

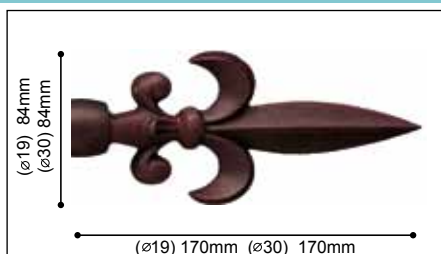

REF	∅				
02369-NFL	19	10	9,18 €	10,56 €	
02369-OFL	19	10	11,02 €	12,67 €	
02369-XFL	19	10	11,02 €	12,67 €	
02369-BFL	19	10	11,02 €	12,67 €	
02368-NFL	30	10	10,82 €	12,44 €	
02368-OFL	30	10	12,98 €	14,93 €	
02368-XFL	30	10	12,98 €	14,93 €	
02368-BFL	30	10	12,98 €	14,93 €	

Accesorios / Accessories / Accessoires



Soporte Pared Sencillo

Single
Wall Bracket /
Support
Mur Simple

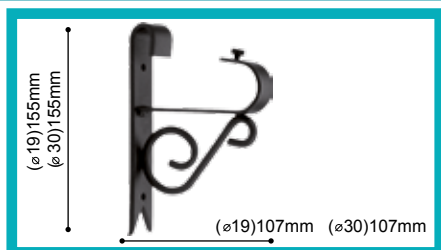

REF	∅				
02369-NF	19	10	6,84 €	7,87 €	
02369-OF	19	10	8,22 €	9,45 €	
02369-XF	19	10	8,22 €	9,45 €	
02369-BF	19	10	8,22 €	9,45 €	
02368-NF	30	10	9,12 €	10,49 €	
02368-OF	30	10	10,94 €	12,58 €	
02368-XF	30	10	10,94 €	12,58 €	
02368-BF	30	10	10,94 €	12,58 €	

* Soporte incluido en el Kit Sencillo /
Bracket supplied in the Single Kit / Support fourni dans le Simple Kit.

Soporte Pared Doble

Double Wall Bracket /
Support Mur Double

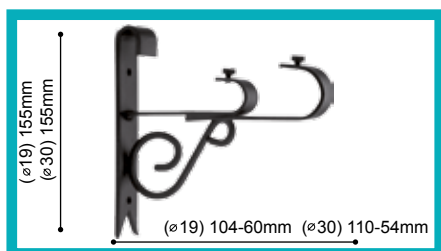

REF	∅				
02369-ND	19 / 19	10	10,28 €	11,82 €	
02369-OD	19 / 19	10	12,34 €	14,19 €	
02369-XD	19 / 19	10	12,34 €	14,19 €	
02369-BD	19 / 19	10	12,34 €	14,19 €	
02368-ND	30 / 19	10	10,92 €	12,56 €	
02368-OD	30 / 19	10	13,10 €	15,07 €	
02368-XD	30 / 19	10	13,10 €	15,07 €	
02368-BD	30 / 19	10	13,10 €	15,07 €	

* Soporte incluido en el Kit Doble /
Bracket supplied in the Double Kit / Support fourni dans le Double Kit.

Soporte Dintel

Recess Bracket /
Entre-Murs

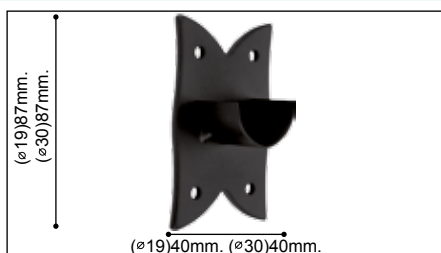

REF	∅				
02369-NL	19	10	4,10 €	4,72 €	
02369-OL	19	10	4,92 €	5,66 €	
02369-XL	19	10	4,92 €	5,66 €	
02369-BL	19	10	4,92 €	5,66 €	
02368-NL	30	10	4,10 €	4,72 €	
02368-OL	30	10	4,92 €	5,66 €	
02368-XL	30	10	4,92 €	5,66 €	
02368-BL	30	10	4,92 €	5,66 €	

Accesorios / Accessories / Accessoires



SopORTE
Pared Sencillo

Single
Wall Bracket /
Support
Mur Simple

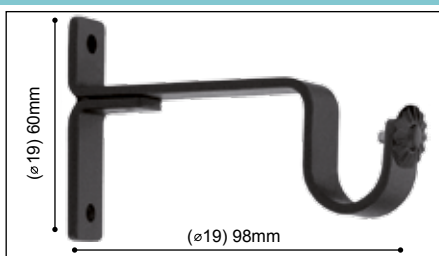

REF	∅	U	€	€	cm
02370-NBF	19	25	2,42 €	2,78 €	
02370-OBF	19	25	2,92 €	3,36 €	
02370-XBF	19	25	2,92 €	3,36 €	
02370-BBF	19	25	2,92 €	3,36 €	

SopORTE
Pared Doble

Double Wall
Bracket /
Support
Mur Double

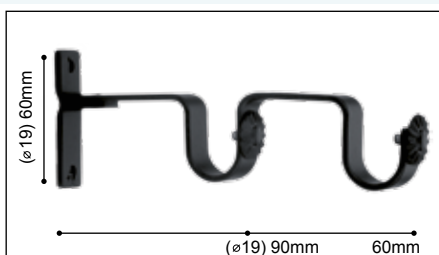

REF	∅	U	€	€	cm
02370-NBD	19 / 19	25	4,20 €	4,83 €	
02370-OBD	19 / 19	25	5,06 €	5,82 €	
02370-XBD	19 / 19	25	5,06 €	5,82 €	
02370-BBD	19 / 19	25	5,06 €	5,82 €	

SopORTE
Techo Doble

Double Ceiling
Bracket /
Support
Plafond Double

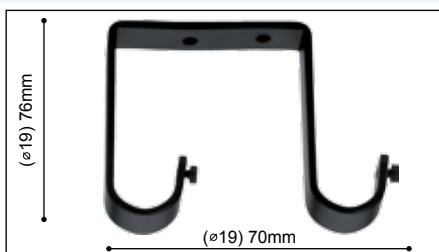

REF	∅	U	€	€	cm
02369-NDT	19 / 19	25	4,68 €	5,38 €	
02369-ODT	19 / 19	25	5,62 €	6,46 €	
02369-XDT	19 / 19	25	5,62 €	6,46 €	
02369-BDT	19 / 19	25	5,62 €	6,46 €	

SopORTE
Techo Corto

Single Ceiling
Bracket /
Support
Plafond Simple



REF	∅	U	€	€	cm
02369-NTE	19	10	6,52 €	7,50 €	
02369-OTE	19	10	7,84 €	9,02 €	
02369-XTE	19	10	7,84 €	9,02 €	
02369-BTE	19	10	7,84 €	9,02 €	
02368-NTC	30	10	6,52 €	7,50 €	
02368-OTC	30	10	7,84 €	9,02 €	
02368-XTC	30	10	7,84 €	9,02 €	
02368-BTC	30	10	7,84 €	9,02 €	

SopORTE
Techo Sencillo

Ceiling Bracket /
Support
Plafond Simple



*Bajo pedido

REF	∅	U	€	€	cm
02369-NTEL	19	10	6,52 €	7,50 €	
02369-OTEL	19	10	7,84 €	9,02 €	
02369-XTEL	19	10	7,84 €	9,02 €	
02369-BTEL	19	10	7,84 €	9,02 €	
02368-NTE	30	10	6,52 €	7,50 €	
02368-OTE	30	10	7,84 €	9,02 €	
02368-XTE	30	10	7,84 €	9,02 €	
02368-BTE	30	10	7,84 €	9,02 €	

SopORTE
Extensible
Pared

Extensible Wall Bra-
cket /
Support
Mur Extensible

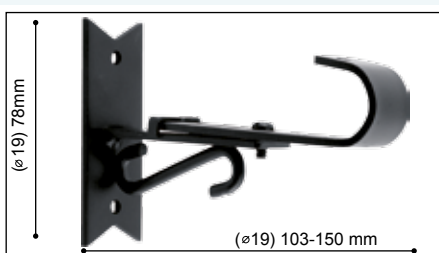

REF	∅	U	€	€	cm
02369-NFE	19	10	6,30 €	7,25 €	
02369-OFE	19	10	7,54 €	8,67 €	
02369-XFE	19	10	7,54 €	8,67 €	
02369-BFE	19	10	7,54 €	8,67 €	

Accesorios / Accessories / Accessoires



Soporte Extensible Doble de Pared
Double Extensible Wall Bracket / Support Mur Double Extensible

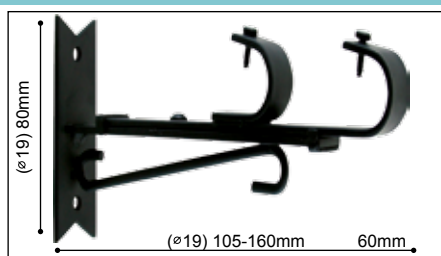

REF	∅				
02369-NDE	19/19	10	7,42 €	8,53 €	
02369-ODE	19/19	10	8,92 €	10,26 €	
02369-XDE	19/19	10	8,92 €	10,26 €	
02369-BDE	19/19	10	8,92 €	10,26 €	

Soporte Extensible Largo de Pared
Long Extensible Wall Bracket / Support Mur Long Extensible

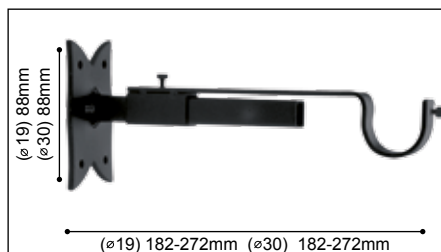

*Bajo pedido

REF	∅				
N.10219N	19	10	11,26 €	12,95 €	
N.10219NO	19	10	13,50 €	15,53 €	
N.10219OX	19	10	13,50 €	15,53 €	
N.10219MO	19	10	13,50 €	15,53 €	
N.10230N	30	10	11,26 €	12,95 €	
N.10230NO	30	10	13,50 €	15,53 €	
N.10230OX	30	10	13,50 €	15,53 €	
N.10230MO	30	10	13,50 €	15,53 €	

Soporte Pared Redondo Extensible
Extensible Wall Bracket / Support Mur Extensible

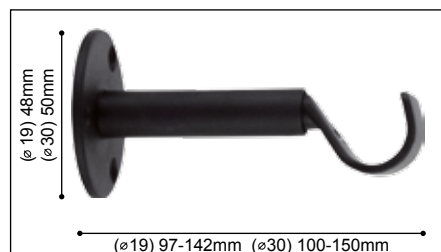

REF	∅				
02369-N20019	19	10	8,14 €	9,36 €	
02369-O20019	19	10	9,76 €	11,22 €	
02369-X20019	19	10	9,76 €	11,22 €	
02369-B20019	19	10	9,76 €	11,22 €	
02368-N20030	30	10	8,72 €	10,03 €	
02368-O20030	30	10	10,46 €	12,03 €	
02368-X20030	30	10	10,46 €	12,03 €	
02368-B20030	30	10	10,46 €	12,03 €	

Soporte Pared Doble Redondo Extensible
Extensible Double Wall Bracket / Support Double Mur Extensible

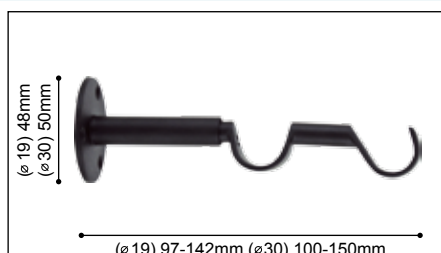

REF	∅				
02369-N21119	19/19	10	8,94 €	10,28 €	
02369-O21119	19/19	10	10,74 €	12,35 €	
02369-X21119	19/19	10	10,74 €	12,35 €	
02369-B21119	19/19	10	10,74 €	12,35 €	
02368-N21319	30/19	10	10,52 €	12,10 €	
02368-O21319	30/19	10	12,66 €	14,56 €	
02368-X21319	30/19	10	12,66 €	14,56 €	
02368-B21319	30/19	10	12,66 €	14,56 €	

Adaptador de Terminal

Iron Finial Adaptor / Adaptateur D'Embout



REF	∅				
02369-N306		10	2,82 €	3,24 €	
02369-O306		10	3,38 €	3,89 €	
02369-X306		10	3,38 €	3,89 €	
02369-B306		10	3,38 €	3,89 €	

Accesorios / Accessories / Accessoires



Codo Articulado para Tubo de Hierro

Iron Articuled Elbow / Coude en Fer Articulé



REF	∅	U	€	1	cm
02369-NC150	19	10	8,88 €	10,21 €	
02369-OC150	19	10	10,66 €	12,26 €	
02369-XC150	19	10	10,66 €	12,26 €	
02369-BC150	19	10	10,66 €	12,26 €	
02368-NC151	30	10	13,12 €	15,09 €	
02368-OC151	30	10	15,72 €	18,08 €	
02368-XC151	30	10	15,72 €	18,08 €	
02368-BC151	30	10	15,72 €	18,08 €	

Codo Articulado para Tubo de Hierro

Iron Articuled Elbow / Coude en Fer Articulé



REF	∅	U	€	1	cm
02369-NC0142	19	10	19,46 €	22,38 €	
02369-OC0142	19	10	23,36 €	26,86 €	
02369-XC0142	19	10	23,36 €	26,86 €	
02369-BC0142	19	10	23,36 €	26,86 €	
02368-NC0144	30	10	26,60 €	30,59 €	
02368-OC0144	30	10	31,94 €	36,73 €	
02368-XC0144	30	10	31,94 €	36,73 €	
02368-BC0144	30	10	31,94 €	36,73 €	

Barra Negra

Black Pole / Tube Noir



REF	∅	U	€	1	cm
02369-N100	19	10	5,20 €	5,98 €	100
02369-N150	19	10	7,80 €	8,97 €	150
02369-N200	19	10	10,40 €	11,96 €	200
02369-N250	19	10	13,00 €	14,95 €	250
02369-N300	19	10	15,60 €	17,94 €	300
02369-N600	19	5	31,20 €	35,88 €	600
02368-N100	30	10	8,00 €	9,20 €	100
02368-N150	30	10	12,00 €	13,80 €	150
02368-N200	30	10	16,00 €	18,40 €	200
02368-N250	30	10	20,00 €	23,00 €	250
02368-N300	30	10	24,00 €	27,60 €	300
02368-N600	30	5	48,00 €	55,20 €	600

Barra Negro - Oro

Black - Gold Pole / Tube Noir - Or



REF	∅	U	€	1	cm
02369-O100	19	10	6,24 €	7,18 €	100
02369-O150	19	10	9,36 €	10,76 €	150
02369-O200	19	10	12,48 €	14,35 €	200
02369-O250	19	10	15,60 €	17,94 €	250
02369-O300	19	10	18,72 €	21,53 €	300
02369-O600	19	5	37,44 €	43,06 €	600
02368-O100	30	10	9,16 €	10,53 €	100
02368-O150	30	10	13,74 €	15,80 €	150
02368-O200	30	10	18,32 €	21,07 €	200
02368-O250	30	10	22,90 €	26,34 €	250
02368-O300	30	10	27,48 €	31,60 €	300
02368-O600	30	5	53,16 €	61,13 €	600

Accesorios / Accessories / Accessoires

Barra
Marfil - OroIvory - Gold Pole /
Tube Ivoire - Or

REF	∅	U	€	€	cm
02369-B100	19	10	6,24 €	7,18 €	100
02369-B150	19	10	9,36 €	10,76 €	150
02369-B200	19	10	12,48 €	14,35 €	200
02369-B250	19	10	15,60 €	17,94 €	250
02369-B300	19	10	18,72 €	21,53 €	300
02369-B600	19	5	37,44 €	43,06 €	600
02368-B100	30	10	9,16 €	10,53 €	100
02368-B150	30	10	13,74 €	15,80 €	150
02368-B200	30	10	18,32 €	21,07 €	200
02368-B250	30	10	22,90 €	26,34 €	250
02368-B300	30	10	27,48 €	31,60 €	300
02368-B600	30	5	53,16 €	61,13 €	600

Barra
Negro - ÓxidoBlack-Rust Pole /
Tube Noir-Rouillé

REF	∅	U	€	€	cm
02369-X100	19	10	6,24 €	7,18 €	100
02369-X150	19	10	9,36 €	10,76 €	150
02369-X200	19	10	12,48 €	14,35 €	200
02369-X250	19	10	15,60 €	17,94 €	250
02369-X300	19	10	18,72 €	21,53 €	300
02369-X600	19	5	37,44 €	43,06 €	600
02368-X100	30	10	9,16 €	10,53 €	100
02368-X150	30	10	13,74 €	15,80 €	150
02368-X200	30	10	18,32 €	21,07 €	200
02368-X250	30	10	22,90 €	26,34 €	250
02368-X300	30	10	27,48 €	31,60 €	300
02368-X600	30	5	53,16 €	61,13 €	600

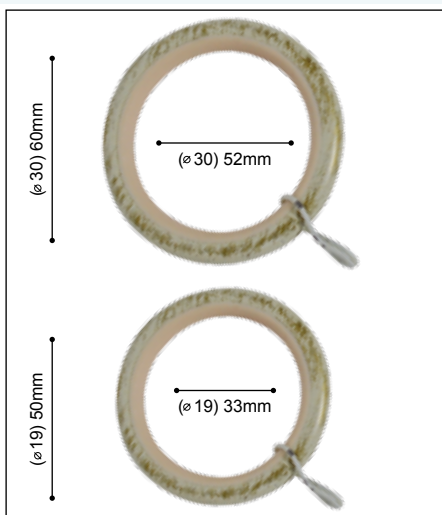
Anillas
con TeflónRing with teflon /
Anneaux avec teflon

REF	∅	U	€	€	cm
02369-NA	19	100	0,68 €	0,78 €	
02369-OA	19	100	0,82 €	0,94 €	
02369-XA	19	100	0,82 €	0,94 €	
02369-BA	19	100	0,82 €	0,94 €	
02368-NA	30	50	1,04 €	1,20 €	
02368-OA	30	50	1,24 €	1,43 €	
02368-XA	30	50	1,24 €	1,43 €	
02368-BA	30	50	1,24 €	1,43 €	

Anillas Hierro

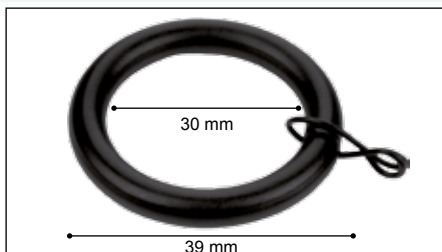
Iron Ring /
Anneaux Fer

REF	∅	U	€	€	cm
02950-119N10	19	100	0,34 €	0,39 €	
02950-119O10	19	100	0,36 €	0,41 €	
02950-119X10	19	100	0,36 €	0,41 €	
02950-119B10	19	100	0,36 €	0,41 €	

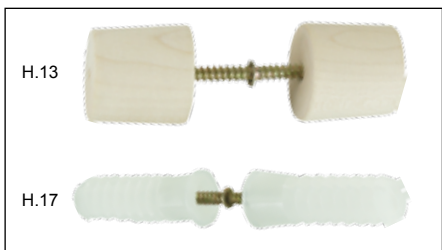
Empalme
para Barra
de ForjaPole Splice /
Raccord pour
des Tringles
en fer Forgé

REF	∅	U	€	€	cm
02369-1517	19	10	1,40 €	1,61 €	
02368-1513	30	10	4,64 €	5,34 €	

Accesorios / Accessories / Accessoires



Gancho

Hook /
Gond



REF	∅	U	€	1	cm
02369-N1001		50	1,48 €	1,70 €	
02369-O1001		50	1,74 €	2,00 €	
02369-X1001		50	1,74 €	2,00 €	
02369-B1001		50	1,74 €	2,00 €	
02369-N1063		50	1,62 €	1,86 €	
02369-O1063		50	1,84 €	2,12 €	
02369-X1063		50	1,84 €	2,12 €	
02369-B1063		50	1,84 €	2,12 €	

*Abrazadera

*Holdback /
*Embrasse



REF	∅	U	€	1	cm
02369-N1326		10	6,28 €	7,22 €	
02369-O1326		10	7,52 €	8,65 €	
02369-X1326		10	7,52 €	8,65 €	
02369-B1326		10	7,52 €	8,65 €	

Tirador

Iron Wand /
Lance Rideau



REF	∅	U	€	1	cm
02369-NTI		25	1,86 €	2,14 €	100
02369-OTI		25	2,24 €	2,58 €	100
02369-XTI		25	2,24 €	2,58 €	100
02369-BTI		25	2,24 €	2,58 €	100

Alzapaños
Flor de Lys

Fleur-de-Lys
holdback /
Embrasse de
rideau Fleur de Lys

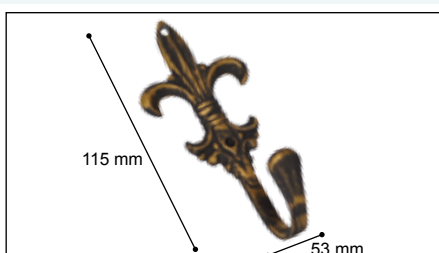

REF	∅	U	€	1	cm
02369-N1125		25	3,28 €	3,77 €	
02369-O1125		25	3,94 €	4,53 €	
02369-X1125		25	3,94 €	4,53 €	
02369-B1125		25	3,94 €	4,53 €	

Rosetón (resina)

Rosette (resin) /
Rosace (résine)



REF	∅	U	€	1	cm
02369-N1328		10	4,16 €	4,78 €	
02369-O1328		10	5,00 €	5,75 €	
02369-X1328		10	5,00 €	5,75 €	
02369-B1328		10	5,00 €	5,75 €	

Prolongador

Spindle /
Balustre

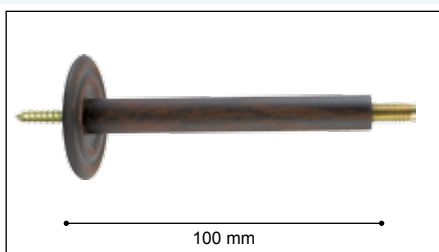

REF	∅	U	€	1	cm
02369-N1166		25	4,62 €	5,31 €	10
02369-O1166		25	5,54 €	6,37 €	10
02369-X1166		25	5,54 €	6,37 €	10
02369-B1166		25	5,54 €	6,37 €	10

Prolongador

Spindle /
Balustre

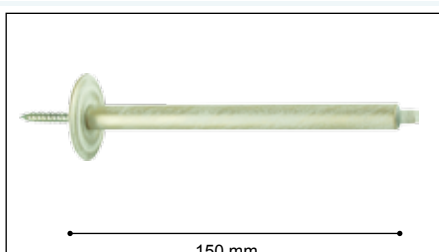

REF	∅	U	€	1	cm
02369-N1167		25	5,54 €	6,37 €	15
02369-O1167		25	6,64 €	7,64 €	15
02369-X1167		25	6,64 €	7,64 €	15
02369-B1167		25	6,64 €	7,64 €	15

Accesorios / Accessories / Accessoires

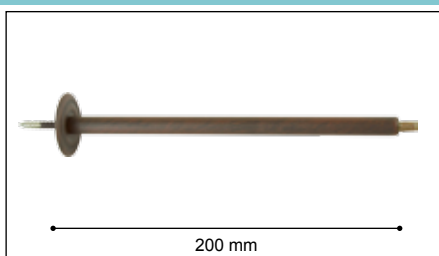

Prolongador

Spindle /
Balustre

REF	∅				
02369-N1168		25	10,36 €	11,91 €	20
02369-O1168		25	12,28 €	14,12 €	20
02369-X1168		25	12,28 €	14,12 €	20
02369-B1168		25	12,28 €	14,12 €	20

Expositor
FORJA 1Wrought Iron
Display Board 1/
Presentoir FORGE 1

REF	∅				
M.214		1		51,40 €	

Expositor
FORJA 2Wrought Iron
Display Board 2/
Presentoir FORGE 2

REF	∅				
M.208		1		51,40 €	

CORTINAS ENROLLABLES

Ponemos a disposición de nuestros clientes una amplia gama de tejidos técnicos para cortinas enrollables. Solicite catálogos y tarifas.



Barra de Cortina BELMONTE / BELMONTE Curtain Pole / Tringle a Rideux BELMONTE



La Colección Belmonte está desarrollada en Madera y presenta 6 terminales en 6 colores diferentes. Se trata de una colección de estilo clásico pero donde lo más llamativo es su potente colorido moderno que la convierte en la combinación más actual en la decoración. Los estilos Vintage, DIY, Nórdico... están de enhorabuena con la aparición de esta colección capaz de unificar estilos de gran popularidad actualmente. Se trata de una colección que nos han pedido decoradores e interioristas y por fin, la hemos diseñado.

The Belmonte Collection is made of wood and offered in 6 finials with 6 different colors. It is a classic style collection but due to its appealing colorful look it becomes the latest trendy combination in terms of decoration. Happy time for people fond of the vintage, DIY and Nordic trends, our new collection gets all in one. It has been very demanded by Decorators and Interior Designers, and finally we are launching it.

La collection Belmonte est entièrement réalisée en bois et se présente en 6 embouts avec 6 gammes de couleurs. Il s'agit d'une collection classique et élégante mais prendre l'apparence d'une gamme de top tendance née de son choquante colori visuel. Des beaux jours pour les amants des modes vintage, DIY et Nordique, en apportant une véritable solution tout-en-un. Très demandée par Concepteurs et Décorateurs d'intérieur, finalement nous l'avons mis sur le marché.



Llama Bronce



Llama Negro-Plata



Llama Marfil



Llama Plata-Oro



Llama Blanco-Plata



Llama Oro-Rojo

∅ 35 mm



Cáliz Bronce



Cáliz Negro-Plata



Cáliz Marfil

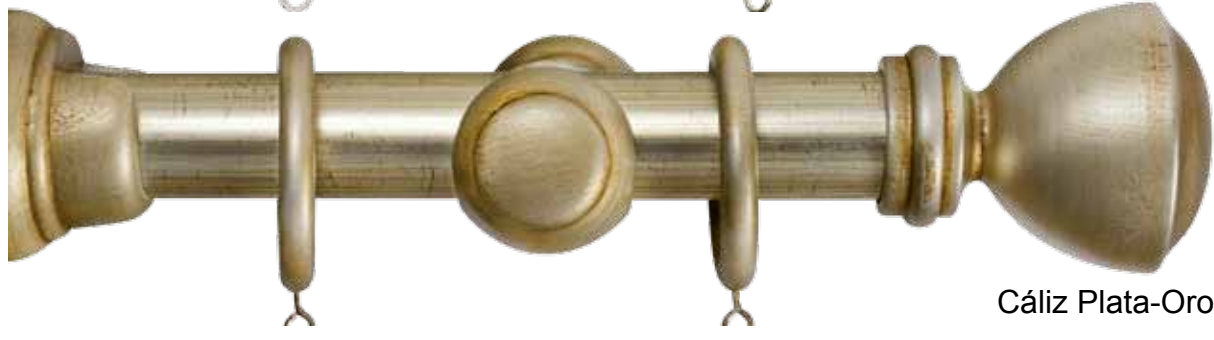

Cáliz Plata-Oro



Cáliz Blanco-Plata



Cáliz Oro-Rojo

∅ 35 mm



Bola Estriada Bronce



Bola Estriada Plata



Bola Estriada Marfil



Bola Estriada Plata-Oro



Bola Estriada Blanco-Plata



Bola Estriada Oro-Rojo

∅ 35 mm



Bellota Bronce



Bellota Negro-Plata



Bellota Marfil

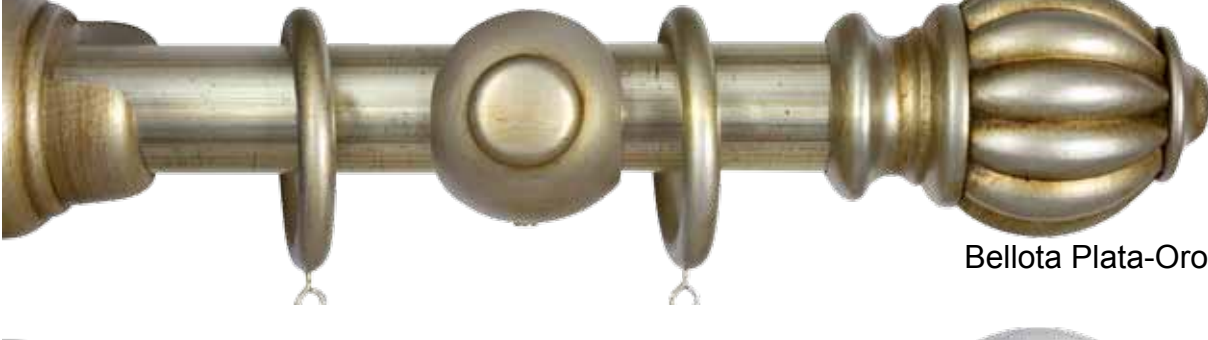

Bellota Plata-Oro



Bellota Blanco-Plata



Bellota Oro-Rojo

∅ 35 mm



Vela Bronce



Vela Negro-Plata



Vela Marfil



Vela Plata-Oro



Vela Blanco-Plata



Vela Oro-Rojo

∅ 35 mm



Tapón Bronce

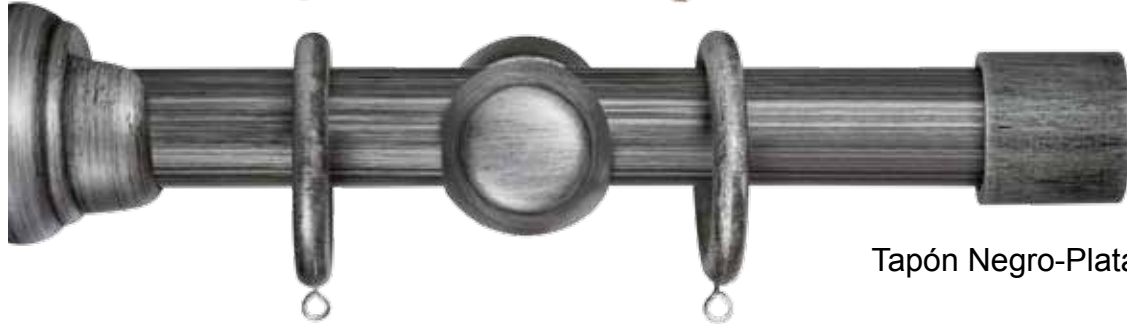

Tapón Negro-Plata



Tapón Marfil

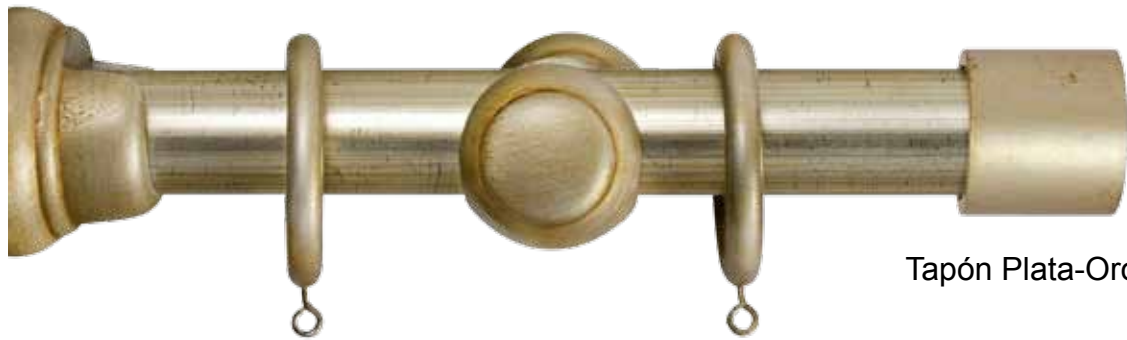

Tapón Plata-Oro



Tapón Blanco-Plata



Tapón Oro-Rojo

∅ 35 mm

Conjuntos completos BELMONTE /
Complete sets BELMONTE /
Kits complete BELMONTE



Llama



U	Ø 35 REF K.18604	Ø 35/35 REF K.18605	cm
1	194,53 €	388,84 €	16
1	214,75 €	429,27 €	20
1	252,10 €	503,86 €	24
1	282,44 €	564,54 €	30

Cáliz



U	Ø 35 REF K.18204	Ø 35/35 REF K.18205	cm
1	151,48 €	302,73 €	16
1	171,70 €	343,16 €	20
1	209,05 €	417,75 €	24
1	239,38 €	478,42 €	30

Bola Estriada



U	Ø 35 REF K.18304	Ø 35/35 REF K.18305	cm
1	146,28 €	292,33 €	16
1	166,50 €	332,76 €	20
1	203,85 €	407,35 €	24
1	234,19 €	468,03 €	30

Bellota



U	Ø 35 REF K.18404	Ø 35/35 REF K.18405	cm
1	194,53 €	388,84 €	16
1	214,75 €	429,27 €	20
1	252,10 €	503,86 €	24
1	282,44 €	564,54 €	30

Vela





U	Ø 35 REF K.18504	Ø 35/35 REF K.18505	cm
1	194,53 €	388,84 €	16
1	214,75 €	429,27 €	20
1	252,10 €	503,86 €	24
1	282,44 €	564,54 €	30

Tapón



U	Ø 35 REF K.18104	Ø 35/35 REF K.18105	cm
1	135,75 €	271,26 €	16
1	155,96 €	311,70 €	20
1	193,32 €	386,29 €	24
1	223,65 €	446,96 €	30

-  Los conjuntos dobles se sirven con terminal tapón en la barra trasera.
 Los conjuntos de medida superior a 2 m se sirven con 3 soportes.
 Conjuntos Sencillos: 2 terminales, 2 soportes, barra y anillas.
 Conjuntos Dobles: 4 term., 2 sop.dobles, 2 barras y anillas.
 Indique en su pedido el acabado y la medida de la barra que desea.

Importante / Important / Important

Las barras Belmonte se sirven taladradas por ambos extremos para una fácil instalación del terminal. Si corta la barra en algún extremo, para facilitar la correcta y rápida instalación del terminal, es necesario taladrar el centro de los nuevos extremos cortados, con un taladro de 5 mm de diámetro y con 4 cm de profundidad para poder colocar el terminal. /

The Belmonte poles are supplied drilled on both ends for easy installation of finials. If you need to cut the poles, for an easy and proper finial installation, you should drill the center of the new end/s cut, with a 5mm diameter drill and making a hole of 4cm in order the finial fits in correctly. /



Les tringles en bois Belmonte sont fournies percées dans les extrémités pour assurer une installation correcte des embouts. Si vous avez besoin de couper les tringles, et pour assurer une installation correcte des embouts, vous devez percer le/s extrémité/s coupées avec une perceuse de 5mm et faire un trou de 4cm afin que les embouts s'ajustent parfaitement.

Terminales / Finials / Embouts



Llama



REF	∅				COLOR
05203-BRLL	35	6	34,52 €	39,70 €	bronce
05203-NPLL	35	6	34,52 €	39,70 €	negro plata
05203-MALL	35	6	34,52 €	39,70 €	marfil
05203-POLL	35	6	34,52 €	39,70 €	plata oro
05203-BPLL	35	6	34,52 €	39,70 €	blanco plata
05203-ORLL	35	6	34,52 €	39,70 €	oro rojo

NEW

Cáliz





REF	∅				COLOR
05203-BRCA	35	6	15,80 €	18,17 €	bronce
05203-NPCA	35	6	15,80 €	18,17 €	negro plata
05203-MACA	35	6	15,80 €	18,17 €	marfil
05203-POCA	35	6	15,80 €	18,17 €	plata oro
05203-BPCA	35	6	15,80 €	18,17 €	blanco plata
05203-ORCA	35	6	15,80 €	18,17 €	oro rojo

NEW

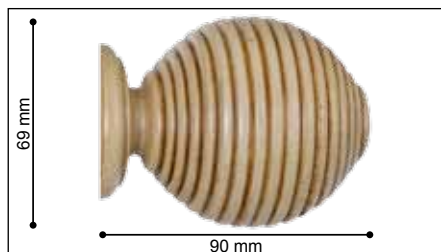
Bola Estriada





REF	∅				COLOR
05203-BRBE	35	6	13,54 €	15,57 €	bronce
05203-NPBE	35	6	13,54 €	15,57 €	negro plata
05203-MABE	35	6	13,54 €	15,57 €	marfil
05203-POBE	35	6	13,54 €	15,57 €	plata oro
05203-BPBE	35	6	13,54 €	15,57 €	blanco plata
05203-ORBE	35	6	13,54 €	15,57 €	oro rojo

NEW

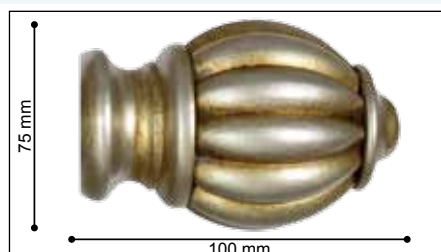
Bellota



REF	∅				COLOR
05203-BRGA	35	6	34,52 €	39,70 €	bronce
05203-NPGA	35	6	34,52 €	39,70 €	negro plata
05203-MAGA	35	6	34,52 €	39,70 €	marfil
05203-POGA	35	6	34,52 €	39,70 €	plata oro
05203-BPGA	35	6	34,52 €	39,70 €	blanco plata
05203-ORGA	35	6	34,52 €	39,70 €	oro rojo

NEW

Terminales / Finials / Embouts



Vela



REF	∅	U	€	€	COLOR
05203-BRPI	35	6	34,52 €	39,70 €	bronce
05203-NPPI	35	6	34,52 €	39,70 €	negro plata
05203-MAPI	35	6	34,52 €	39,70 €	marfil
05203-POPI	35	6	34,52 €	39,70 €	plata oro
05203-BPPI	35	6	34,52 €	39,70 €	blanco plata
05203-ORPI	35	6	34,52 €	39,70 €	oro rojo

NEW

Tapón



REF	∅	U	€	€	COLOR
05203-BRTO	35	6	8,96 €	10,30 €	bronce
05203-NPTO	35	6	8,96 €	10,30 €	negro plata
05203-MATO	35	6	8,96 €	10,30 €	marfil
05203-POTO	35	6	8,96 €	10,30 €	plata oro
05203-BPTO	35	6	8,96 €	10,30 €	blanco plata
05203-ORTO	35	6	8,96 €	10,30 €	oro rojo

NEW

Accesorios / Accessories / Accessoires



Soporte Madera Clásico 35 mm

Classic Wooden Bracket 35 mm / Support Bois Classique 35 mm

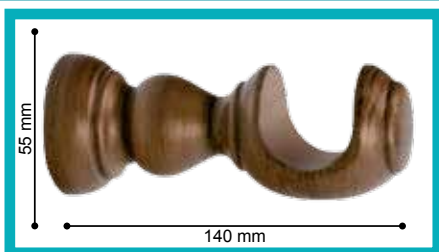

REF	∅	U	€	€	COLOR
05203-BRF	35	6	14,90 €	17,14 €	bronce
05203-NPF	35	6	14,90 €	17,14 €	negro plata
05203-MAF	35	6	14,90 €	17,14 €	marfil
05203-POF	35	6	14,90 €	17,14 €	plata oro
05203-BPF	35	6	14,90 €	17,14 €	blanco plata
05203-ORF	35	6	14,90 €	17,14 €	oro rojo

NEW

* Soporte incluido en el Kit Sencillo / Bracket supplied in the Single Kit / Support fourni dans le Simple Kit.

Soporte Madera Clásico Doble 35 / 35 mm

Classic Wooden Double Bracket 35 / 35 mm / Double Support Bois Classique 35 / 35 mm



REF	∅	U	€	€	COLOR
01203-BRD	35	6	29,70 €	34,16 €	bronce
01203-NPD	35	6	29,70 €	34,16 €	negro plata
01203-MAD	35	6	29,70 €	34,16 €	marfil
01203-POD	35	6	29,70 €	34,16 €	plata oro
01203-BPD	35	6	29,70 €	34,16 €	blanco plata
01203-ORD	35	6	29,70 €	34,16 €	oro rojo

NEW

* Soporte incluido en el Kit Doble / Bracket supplied in the Double Kit / Support fourni dans le Double Kit.

Soporte Madera Clásico Techo 35 mm

Classic Wooden Ceiling Bracket 35 mm / Plafond Support Bois Classique 35 mm



REF	∅	U	€	€	COLOR
01203-BRT	35	6	14,90 €	17,14 €	bronce
01203-NPT	35	6	14,90 €	17,14 €	negro plata
01203-MAT	35	6	14,90 €	17,14 €	marfil
01203-POT	35	6	14,90 €	17,14 €	plata oro
01203-BPT	35	6	14,90 €	17,14 €	blanco plata
01203-ORT	35	6	14,90 €	17,14 €	oro rojo

NEW

Accesorios / Accessories / Accessoires



<p>Soporte Madera Clásico Largo 35 mm</p> <p>Classic Wooden Long Bracket 35 mm / Long Support Bois Classique 35 mm</p>  <p>64 mm 268 mm</p>	REF	∅				COLOR	NEW
	05203-BRG	35	6	22,62 €	26,01 €	bronce	
	05203-NPG	35	6	22,62 €	26,01 €	negro plata	
	05203-MAG	35	6	22,62 €	26,01 €	marfil	
	05203-POG	35	6	22,62 €	26,01 €	plata oro	
	05203-BPG	35	6	22,62 €	26,01 €	blanco plata	
05203-ORG	35	6	22,62 €	26,01 €	oro rojo		
<p>Soporte Madera Clásico Dintel 35 mm</p> <p>Classic Wooden Recess Bracket 35 mm / Naissance Support Bois Classique 35 mm</p>  <p>69 mm 43 mm</p>	REF	∅				COLOR	NEW
	05203-BRL	35	6	11,60 €	13,34 €	bronce	
	05203-NPL	35	6	11,60 €	13,34 €	negro plata	
	05203-MAL	35	6	11,60 €	13,34 €	marfil	
	05203-POL	35	6	11,60 €	13,34 €	plata oro	
	05203-BPL	35	6	11,60 €	13,34 €	blanco plata	
05203-ORL	35	6	11,60 €	13,34 €	oro rojo		
<p>Anilla Madera 35 mm</p> <p>Wooden Ring / Anneau Bois</p>  <p>73 mm 52 mm</p>	REF	∅				COLOR	NEW
	05203-BRA	35	100	1,56 €	1,79 €	bronce	
	05203-NPA	35	100	1,56 €	1,79 €	negro plata	
	05203-MAA	35	100	1,56 €	1,79 €	marfil	
	05203-POA	35	100	1,56 €	1,79 €	plata oro	
	05203-BPA	35	100	1,56 €	1,79 €	blanco plata	
05203-ORA	35	100	1,56 €	1,79 €	oro rojo		
<p>Tirador Madera 1 m</p> <p>Wooden Wand 1 m / Baton Bois 1 m</p>  <p>130 cm</p>	REF	∅				COLOR	NEW
	05203-BRTI		6	24,70 €	28,41 €	bronce	
	05203-NPTI		6	24,70 €	28,41 €	negro plata	
	05203-MATI		6	24,70 €	28,41 €	marfil	
	05203-POTI		6	24,70 €	28,41 €	plata oro	
	05203-BPTI		6	24,70 €	28,41 €	blanco plata	
05203-ORTI		6	24,70 €	28,41 €	oro rojo		
<p>Alzapaño Madera Acortable</p> <p>Tailored Wooden Holdback / Embrasse Bois Raccourcissable</p>  <p>225 mm</p>	REF	∅				COLOR	NEW
	05203-BRZ	35	6	17,06 €	19,62 €	bronce	
	05203-NPZ	35	6	17,06 €	19,62 €	negro plata	
	05203-MAZ	35	6	17,06 €	19,62 €	marfil	
	05203-POZ	35	6	17,06 €	19,62 €	plata oro	
	05203-BPZ	35	6	17,06 €	19,62 €	blanco plata	
05203-ORZ	35	6	17,06 €	19,62 €	oro rojo		
<p>Barra de Madera 35 mm Bronce</p> <p>Wooden Poles 35 mm Bronze / Barre Bois 35 mm Bronze</p> 	REF	∅					NEW
	05203-BR160	35	6	45,36 €	52,16 €	160	
	05203-BR200	35	6	56,70 €	65,21 €	200	
	05203-BR240	35	6	68,04 €	78,25 €	240	
	05203-BR300	35	6	85,06 €	97,82 €	300	
<p>Barra de Madera 35 mm Negro-Plata</p> <p>Wooden Poles 35 mm Black-Silver / Barre Bois 35 mm Noir-Argent</p> 	REF	∅					NEW
	05203-NP160	35	6	45,36 €	52,16 €	160	
	05203-NP200	35	6	56,70 €	65,21 €	200	
	05203-NP240	35	6	68,04 €	78,25 €	240	
	05203-NP300	35	6	85,06 €	97,82 €	300	
<p>Barra de Madera 35 mm Marfil</p> <p>Wooden Poles 35 mm Ivory / Barre Bois 35 mm Ivoire</p> 	REF	∅					NEW
	05203-MA160	35	6	45,36 €	52,16 €	160	
	05203-MA200	35	6	56,70 €	65,21 €	200	
	05203-MA240	35	6	68,04 €	78,25 €	240	
	05203-MA300	35	6	85,06 €	97,82 €	300	

Accesorios / Accessories / Accessoires



Barra de Madera 35 mm Plata-Oro
 Wooden Poles 35 mm Silver-Gold / Barre Bois 35 mm Argent-Or

REF	∅	U	€	€	cm	NEW
05203-PO160	35	6	45,36 €	52,16 €	160	
05203-PO200	35	6	56,70 €	65,21 €	200	
05203-PO240	35	6	68,04 €	78,25 €	240	
05203-PO300	35	6	85,06 €	97,82 €	300	

Barra de Madera 35 mm Blanco-Plata
 Wooden Poles 35 mm White-Silver / Barre Bois 35 mm Blanc-Argent

REF	∅	U	€	€	cm	NEW
05203-BP160	35	6	45,36 €	52,16 €	160	
05203-BP200	35	6	56,70 €	65,21 €	200	
05203-BP240	35	6	68,04 €	78,25 €	240	
05203-BP300	35	6	85,06 €	97,82 €	300	

Barra de Madera 35 mm Oro-Rojo
 Wooden Poles 35 mm Red-Gold / Barre Bois 35 mm Or-Rouge

REF	∅	U	€	€	cm	NEW
05203-OR160	35	6	45,36 €	52,16 €	160	
05203-OR200	35	6	56,70 €	65,21 €	200	
05203-OR240	35	6	68,04 €	78,25 €	240	
05203-OR300	35	6	85,06 €	97,82 €	300	

Expositor BELMONTE
 Exhibitor Belmonte / Presentoir Belmonte

REF	∅	U	€	€	cm	NEW
M.217	35	1		123,76 €		



BELMONTE

Marvent

MARVENT SYSTEM S.L.



nueva
colección



BELMONTE

tu barra de cortina vintage en madera

Barra de Cortina ECLIPSE / ECLIPSE Curtain Pole / Tringle a Rideux ECLIPSE



Cilindro Roble



Cono Invertido Teka



Bola Pino



Olimpo Blanco



Cilindro Wengué

La madera más noble es el material con el que se diseña esta colección. El estilo joven que transmite y el material empleado, dan solución a numerosas decoraciones donde se quiera conseguir el grado más alto de integración posible con la estancia. Gracias a sus diferentes soportes, podremos instalar esta colección en cualquier lugar independientemente de las condiciones del mismo. Aún siendo diseñada para su uso en interiores, la madera está tratada para soportar perfectamente el paso del tiempo en cuanto a rigidez y durabilidad del color.

The hardwood is the material used in the production of this collection. The contemporary style and the material used, provide solutions to numerous decorations where you want to get the highest possible degree of integration with the stay. Thanks to its different support, we can install this collection anywhere regardless of the conditions thereof. Even though it is designed for indoor use, the wood is treated to perfectly support age and durability of colour.

Le bois est le matériel utilisé dans la production de cette collection. Le style contemporain et le matériel utilisé, offre solutions à de nombreuses décorations où vous voulez obtenir le plus haut degré possible d'intégration avec la chambre. Merci à ses supports, nous pouvons installer cette collection à toute type d'installation. Même si il est conçu pour une utilisation en intérieur, le bois est traité pour soutenir parfaitement le temps et la durabilité de la couleur.

ECLIPSE

Conjuntos madera ECLIPSE /
Wood sets ECLIPSE /
Kits bois ECLIPSE

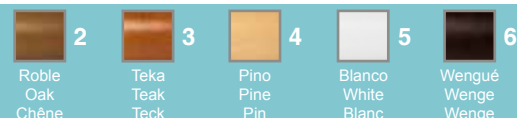

Cilindro Roble, Teka y Pino / Cilindro Oak, Teak and Pine / Cilindro Chêne, Teck and Pin



Roble / Oak / Chêne



Teka / Teak / Teck



Pino / Pine / Pin

	 REF K.901	 REF K.911	 REF K.921	 REF K.931		
1	23,52 €	30,08 €	40,51 €	49,69 €	12	120
1	27,14 €	35,65 €	47,74 €	58,88 €	16	160
1	35,12 €	41,26 €	60,44 €	74,57 €	20	200
1	38,74 €* 46,58 €	50,92 €* 62,62 €	67,68 €* 83,36 €	83,79 €* 103,33 €	24* 32	240 320*

Cilindro Blanco / Cilindro White / Cilindro Blanc



Blanco / White / Blanc

	 REF K.901	 REF K.911	 REF K.921	 REF K.931		
1	30,43 €	38,11 €	53,08 €	63,89 €	12	120
1	35,90 €	46,07 €	64,03 €	77,33 €	16	160
1	46,25 €	54,05 €	80,85 €	97,73 €	20	200
1	51,70 €* 63,31 €	66,40 €* 82,88 €	91,75 €* 114,96 €	111,14 €* 139,22 €	24* 32	240 320*

Cilindro Wengué / Cilindro Wenge / Cilindro Wenge



Wengué / Wenge / Wenge

	 REF K.901	 REF K.911	 REF K.921	 REF K.931		
1	24,39 €	31,40 €	42,26 €	51,88 €	12	120
1	28,29 €	37,42 €	50,04 €	61,80 €	16	160
1	36,57 €	43,47 €	63,34 €	78,22 €	20	200
1	40,44 €* 48,88 €	53,54 €* 66,16 €	71,08 €* 87,96 €	88,12 €* 109,18 €	24* 32	240 320*

Conjuntos madera ECLIPSE /
Wood sets ECLIPSE /
Kits bois ECLIPSE

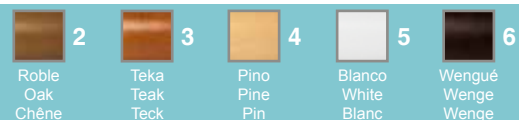

Cono Roble, Teka y Pino / Cono Oak, Teak and Pine / Cono Chêne, Teck and Pin



U	Ø 19 REF K.902	Ø 30 REF K.912	Ø 19/19 REF K.922	Ø 30/19 REF K.932	⊗	cm
1	23,52 €	31,69 €	40,51 €	51,30 €	12	120
1	27,14 €	37,26 €	47,74 €	60,49 €	16	160
1	35,12 €	42,87 €	60,44 €	76,18 €	20	200
1	38,74 €* 46,58 €	52,53 €* 64,23 €	67,68 €* 83,36 €	85,40 €* 104,94 €	24* 32	240 320*

Cono Blanco / Cono White / Cono Blanc



U	Ø 19 REF K.902	Ø 30 REF K.912	Ø 19/19 REF K.922	Ø 30/19 REF K.932	⊗	cm
1	30,43 €	40,00 €	53,08 €	65,78 €	12	120
1	35,90 €	47,96 €	64,03 €	79,21 €	16	160
1	46,25 €	55,94 €	80,85 €	99,61 €	20	200
1	51,70 €* 63,31 €	68,29 €* 84,77 €	91,75 €* 114,96 €	113,02 €* 141,11 €	24* 32	240 320*

Cono Wengué / Cono Wenge / Cono Wenge



U	Ø 19 REF K.902	Ø 30 REF K.912	Ø 19/19 REF K.922	Ø 30/19 REF K.932	⊗	cm
1	24,39 €	33,01 €	42,26 €	53,49 €	12	120
1	28,29 €	39,03 €	50,04 €	63,41 €	16	160
1	36,57 €	45,08 €	63,34 €	79,83 €	20	200
1	40,44 €* 48,88 €	55,15 €* 67,77 €	71,08 €* 87,96 €	89,73 €* 110,79 €	24* 32	240 320*

ECLIPSE

Conjuntos madera **ECLIPSE** /
Wood sets **ECLIPSE** /
Kits bois **ECLIPSE**

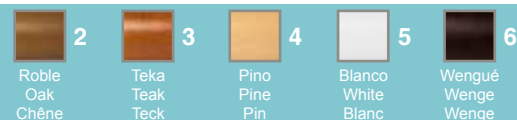

Olimpo Roble, Teka y Pino / Olimpo Oak, Teak and Pine / Olimpo Chêne, Teck and Pin

		Ø 19 REF K.903	Ø 30 REF K.913	Ø 19/19 REF K.923	Ø 30/19 REF K.933		
 Roble / Oak / Chêne	1	23,52 €	31,05 €	40,51 €	50,66 €	12	120
 Teka / Teak / Teck	1	27,14 €	36,62 €	47,74 €	59,84 €	16	160
 Pino / Pine / Pin	1	38,74 €* 46,58 €	51,89 €* 63,59 €	67,68 €* 83,36 €	84,76 €* 104,30 €	24* 32	240 320*

Olimpo Blanco / Olimpo White / Olimpo Blanc

		Ø 19 REF K.903	Ø 30 REF K.913	Ø 19/19 REF K.923	Ø 30/19 REF K.933		
 Blanco / White / Blanc	1	30,43 €	39,22 €	53,08 €	65,00 €	12	120
	1	35,90 €	47,17 €	64,03 €	78,43 €	16	160
	1	46,25 €	55,15 €	80,85 €	98,83 €	20	200
	1	51,70 €* 63,31 €	67,51 €* 83,99 €	91,75 €* 114,96 €	112,24 €* 140,33 €	24* 32	240 320*

Olimpo Wengué / Olimpo Wenge / Olimpo Wenge

		Ø 19 REF K.903	Ø 30 REF K.913	Ø 19/19 REF K.923	Ø 30/19 REF K.933		
 Wengué / Wenge / Wenge	1	24,39 €	32,36 €	42,26 €	52,84 €	12	120
	1	28,29 €	38,39 €	50,04 €	62,76 €	16	160
	1	36,57 €	44,44 €	63,34 €	79,19 €	20	200
	1	40,44 €* 48,88 €	54,51 €* 67,13 €	71,08 €* 87,96 €	89,08 €* 110,14 €	24* 32	240 320*

Conjuntos madera ECLIPSE /
Wood sets ECLIPSE /
Kits bois ECLIPSE

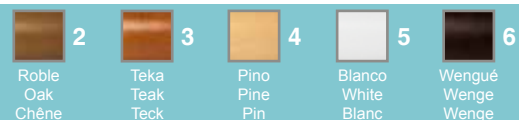

Bola Roble, Teka y Pino / Bola Oak, Teak and Pine / Bola Chêne, Teck and Pin

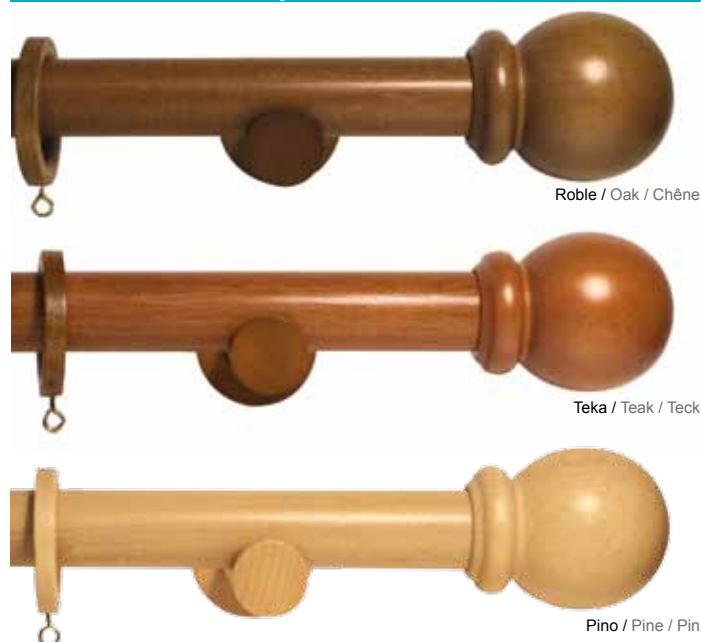

U	Ø 19 REF K.904	Ø 30 REF K.914	Ø 19/19 REF K.924	Ø 30/19 REF K.934	cm	cm
1	23,52 €	32,75 €	40,51 €	52,36 €	12	120
1	27,14 €	38,32 €	47,74 €	61,54 €	16	160
1	35,12 €	43,93 €	60,44 €	77,23 €	20	200
1	38,74 €* 46,58 €	53,59 €* 65,29 €	67,68 €* 83,36 €	86,46 €* 106,00 €	24* 32	240 320*

Bola Blanco / Bola White / Bola Blanc



U	Ø 19 REF K.904	Ø 30 REF K.914	Ø 19/19 REF K.924	Ø 30/19 REF K.934	cm	cm
1	30,43 €	41,06 €	53,08 €	66,84 €	12	120
1	35,90 €	49,01 €	64,03 €	80,27 €	16	160
1	46,25 €	56,99 €	80,85 €	100,67 €	20	200
1	51,70 €* 63,31 €	69,35 €* 85,83 €	91,75 €* 114,96 €	114,08 €* 142,17 €	24* 32	240 320*

Bola Wengué / Bola Wenge / Bola Wenge

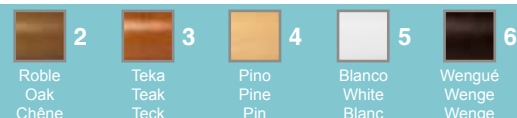

U	Ø 19 REF K.904	Ø 30 REF K.914	Ø 19/19 REF K.924	Ø 30/19 REF K.934	cm	cm
1	24,39 €	34,06 €	42,26 €	54,55 €	12	120
1	28,29 €	40,09 €	50,04 €	64,46 €	16	160
1	36,57 €	46,14 €	63,34 €	80,89 €	20	200
1	40,44 €* 48,88 €	56,21 €* 68,83 €	71,08 €* 87,96 €	90,79 €* 111,84 €	24* 32	240 320*

Contenido del Kit /
Kit components /
Composants du Kit

Conjuntos Sencillos: 2 terminales, 2 soportes, barra y anillas.
Single sets: 2 finials, 2 brackets, pole & rings.
Kits simples: 2 embouts, 2 supports, tube et aneaux.

Indique en su pedido el acabado y la medida de la barra que desea.
When ordering, please specify finish and size of pole.
Merci de spécifier la finition et la taille de la barre.

Conjunto Doble: 2 terminales, 2 tapones, 4 soportes, 2 barra y anillas.

Ø 30: Los conjuntos superiores a 2 m llevan 3 soportes.
All sets with length longer than 2 m are supplied with 3 brackets.
Tous les kits de mesures supérieures à 2 m contiennent 3 supports.

* **A partir de 2,40 metros**, las barras se sirven en dos mitades.

En el Precio está incluida la pieza de empalme.

* From 2.4 m, poles are supplied in 2 halves and one joining screw to that purpose included in the price.

* À partir de 2.4 m, les barres sont fournies in 2 parties et un vis d'union à cette fin inclus dans le prix.

Ø 19: Los conjuntos superiores a 1,6 m llevan 3 soportes.

All sets with length longer than 1,6 m are supplied with 3 brackets.
Tous les kits de mesures supérieures à 1,6 m contiennent 3 supports.

Accesorios / Accessories / Accessoires

Cilindro



REF	Ø				COLOR
03201-RCI	19	10	1,70 €	1,96 €	roble
03201-TCI	19	10	1,70 €	1,96 €	teka
03201-PCI	19	10	1,70 €	1,96 €	pino
03201-BCI	19	10	1,84 €	2,12 €	blanco
03201-WCI	19	10	1,70 €	1,96 €	wengué
03202-RCI	30	10	2,28 €	2,62 €	roble
03202-TCI	30	10	2,28 €	2,62 €	teka
03202-PCI	30	10	2,28 €	2,62 €	pino
03202-BCI	30	10	2,38 €	2,74 €	blanco
03202-WCI	30	10	2,28 €	2,62 €	wengué

Paola



REF	Ø				COLOR
03201-RPA	19	10	1,70 €	1,96 €	roble
03201-TPA	19	10	1,70 €	1,96 €	teka
03201-PPA	19	10	1,70 €	1,96 €	pino
03201-BPA	19	10	1,84 €	2,12 €	blanco
03201-WPA	19	10	1,70 €	1,96 €	wengué
03202-RPA	30	10	2,98 €	3,43 €	roble
03202-TPA	30	10	2,98 €	3,43 €	teka
03202-PPA	30	10	2,98 €	3,43 €	pino
03202-BPA	30	10	3,20 €	3,68 €	blanco
03202-WPA	30	10	2,98 €	3,43 €	wengué

Ares-Dione



REF	Ø				COLOR
03201-RTE	19	10	1,70 €	1,96 €	roble
03201-TTE	19	10	1,70 €	1,96 €	teka
03201-PTE	19	10	1,70 €	1,96 €	pino
03201-BTE	19	10	1,84 €	2,12 €	blanco
03201-WTE	19	10	1,70 €	1,96 €	wengué
03202-RTE	30	10	2,70 €	3,11 €	roble
03202-TTE	30	10	2,70 €	3,11 €	teka
03202-PTE	30	10	2,70 €	3,11 €	pino
03202-BTE	30	10	2,86 €	3,29 €	blanco
03202-WTE	30	10	2,70 €	3,11 €	wengué

Accesorios/
Accessories /
Accessoires

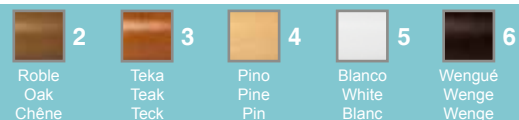

Atlas

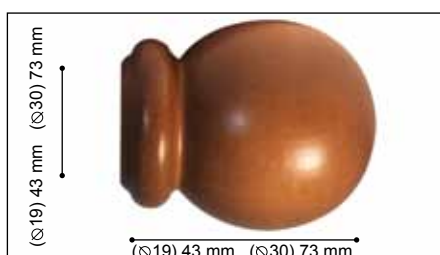

REF	∅	U	€	€	COLOR
03201-RAT	19	10	1,70 €	1,96 €	roble
03201-TAT	19	10	1,70 €	1,96 €	teka
03201-PAT	19	10	1,70 €	1,96 €	pino
03201-BAT	19	10	1,84 €	2,12 €	blanco
03201-WAT	19	10	1,70 €	1,96 €	wengué
03202-RAT	30	10	3,44 €	3,96 €	roble
03202-TAT	30	10	3,44 €	3,96 €	teka
03202-PAT	30	10	3,44 €	3,96 €	pino
03202-BAT	30	10	3,66 €	4,21 €	blanco
03202-WAT	30	10	3,44 €	3,96 €	wengué

Anilla Madera
Plana

Ring /
Anneau



REF	∅	U	€	€	COLOR
03201-RA	19	200	0,216 €	0,248 €	roble
03201-TA	19	200	0,216 €	0,248 €	teka
03201-PA	19	200	0,216 €	0,248 €	pino
03201-BA	19	200	0,56 €	0,64 €	blanco
03201-WA	19	200	0,216 €	0,248 €	wengué
03202-RA	30	200	0,34 €	0,39 €	roble
03202-TA	30	200	0,34 €	0,39 €	teka
03202-PA	30	200	0,34 €	0,39 €	pino
03202-BA	30	200	0,76 €	0,87 €	blanco
03202-WA	30	200	0,34 €	0,39 €	wengué

Soporte Madera
Cilindro

Bracket /
Support

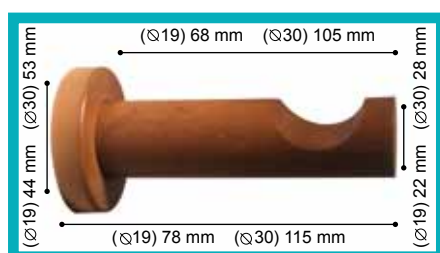

* Soporte incluido en el Kit Sencillo /
Bracket supplied in the Single Kit /
Support fourni dans le Simple Kit

REF	∅	U	€	€	COLOR
03201-RRF	19	10	3,82 €	4,39 €	roble
03201-TRF	19	10	3,82 €	4,39 €	teka
03201-PRF	19	10	3,82 €	4,39 €	pino
03201-BRF	19	10	4,24 €	4,88 €	blanco
03201-WRF	19	10	3,82 €	4,39 €	wengué
03202-RRF	30	10	3,52 €	4,05 €	roble
03202-TRF	30	10	3,52 €	4,05 €	teka
03202-PRF	30	10	3,52 €	4,05 €	pino
03202-BRF	30	10	3,82 €	4,39 €	blanco
03202-WRF	30	10	3,52 €	4,05 €	wengué

Soporte Madera
Cilindro Doble

Double bracket /
Support double

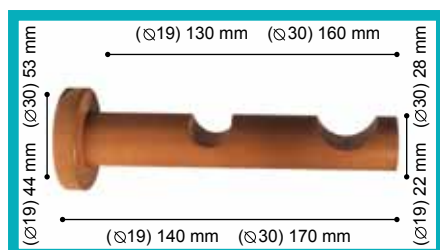

* Soporte incluido en el Kit Doble /
Bracket supplied in the Double Kit /
Support fourni dans le Double Kit.

REF	∅	U	€	€	COLOR
03201-RDF	19 / 19	10	4,80 €	5,52 €	roble
03201-TDF	19 / 19	10	4,80 €	5,52 €	teka
03201-PDF	19 / 19	10	4,80 €	5,52 €	pino
03201-BDF	19 / 19	10	5,10 €	5,87 €	blanco
03201-WDF	19 / 19	10	4,80 €	5,52 €	wengué
03202-RDF	30 / 19	10	5,64 €	6,49 €	roble
03202-TDF	30 / 19	10	5,64 €	6,49 €	teka
03202-PDF	30 / 19	10	5,64 €	6,49 €	pino
03202-BDF	30 / 19	10	6,04 €	6,95 €	blanco
03202-WDF	30 / 19	10	5,64 €	6,49 €	wengué

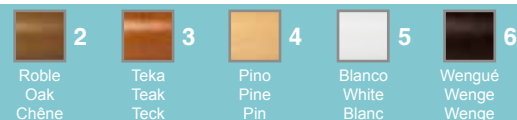
Accesorios /
Accessories /
Accessoires

Codo Madera

Elbow /
Coude

REF	∅				COLOR
03201-RCO	19	1		7,10 €	roble
03201-TCO	19	1		7,10 €	teka
03201-PCO	19	1		7,10 €	pino
03201-BCO	19	1		7,50 €	blanco
03201-WCO	19	1		7,10 €	wengué
03202-RCO	30	1		7,80 €	roble
03202-TCO	30	1		7,80 €	teka
03202-PCO	30	1		7,80 €	pino
03202-BCO	30	1		8,20 €	blanco
03202-WCO	30	1		7,80 €	wengué

Soporte Madera
Cilindro TechoCeiling Bracket /
Support plafond

REF	∅				COLOR
03201-RRT	19	10	6,90 €	7,94 €	roble
03201-TRT	19	10	6,90 €	7,94 €	teka
03201-PRT	19	10	6,90 €	7,94 €	pino
03201-BRT	19	10	7,74 €	8,90 €	blanco
03201-WRT	19	10	6,90 €	7,94 €	wengué
03202-RRT	30	10	7,84 €	9,02 €	roble
03202-TRT	30	10	7,84 €	9,02 €	teka
03202-PRT	30	10	7,84 €	9,02 €	pino
03202-BRT	30	10	8,48 €	9,75 €	blanco
03202-WRT	30	10	7,84 €	9,02 €	wengué

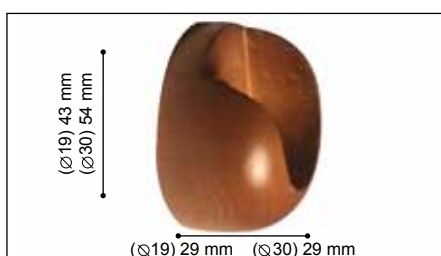
Soporte Madera
DintelRecess bracket /
Support entre-
murs

REF	∅				COLOR
03201-RL	19	1	1,90 €	2,19 €	roble
03201-TL	19	1	1,90 €	2,19 €	teka
03201-PL	19	1	1,90 €	2,19 €	pino
03201-BL	19	1	2,02 €	2,32 €	blanco
03201-WL	19	1	1,90 €	2,19 €	wengué
03202-RL	30	1	2,14 €	2,46 €	roble
03202-TL	30	1	2,14 €	2,46 €	teka
03202-PL	30	1	2,14 €	2,46 €	pino
03202-BL	30	1	2,34 €	2,69 €	blanco
03202-WL	30	1	2,14 €	2,46 €	wengué

Soporte madera

Bracket /
Support

REF	∅				COLOR
03201-RG	19	1	5,52 €	6,35 €	roble
03201-TG	19	1	5,52 €	6,35 €	teka
03201-PG	19	1	5,52 €	6,35 €	pino
03201-BG	19	1	5,86 €	6,74 €	blanco
03201-WG	19	1	5,52 €	6,35 €	wengué
03202-RG	30	1	5,52 €	6,35 €	roble
03202-TG	30	1	5,52 €	6,35 €	teka
03202-PG	30	1	5,52 €	6,35 €	pino
03202-BG	30	1	5,86 €	6,74 €	blanco
03202-WG	30	1	5,52 €	6,35 €	wengué

Accesorios/
Accessories /
Accessoires

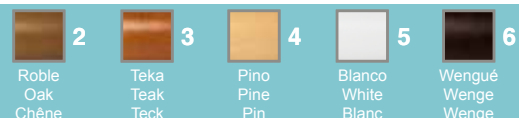

Soporte Madera
Techo Doble

Double ceiling
bracket /
Support double
plafond

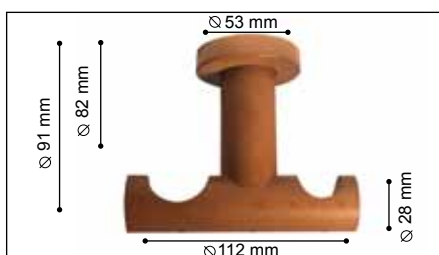

REF	∅	U	€	€ ¹	COLOR
03202-RDT	30/19	10	8,42 €	9,68 €	roble
03202-TDT	30/19	10	8,42 €	9,68 €	teka
03202-PDT	30/19	10	8,42 €	9,68 €	pino
03202-BDT	30/19	10	9,42 €	10,83 €	blanco
03202-WDT	30/19	10	8,42 €	9,68 €	wengué

Soporte Madera
Clásico 19 mm

Bracket Classic /
Support Classique



REF	∅	U	€	€ ¹	COLOR
03201-RF	19	10	2,78 €	3,20 €	roble
03201-TF	19	10	2,78 €	3,20 €	teka
03201-PF	19	10	2,78 €	3,20 €	pino
03201-BF	19	10	2,92 €	3,36 €	blanco
03201-WF	19	10	2,78 €	3,20 €	wengué

Soporte Madera
Clásico 30 mm

Bracket Classic /
Support Classique



REF	∅	U	€	€ ¹	COLOR
03202-RF	30	10	4,98 €	5,73 €	roble
03202-TF	30	10	4,98 €	5,73 €	teka
03202-PF	30	10	4,98 €	5,73 €	pino
03202-BF	30	10	5,28 €	6,07 €	blanco
03202-WF	30	10	4,98 €	5,73 €	wengué

Soporte Madera
Clásico 19 mm
a Techo

Bracket Ceiling
Classic /
Supportau
plafond Classique

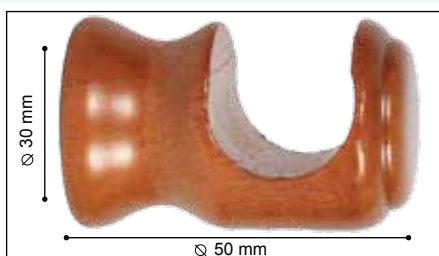

REF	∅	U	€	€ ¹	COLOR
03201-RT	19	10	2,56 €	2,94 €	roble
03201-TT	19	10	2,56 €	2,94 €	teka
03201-PT	19	10	2,56 €	2,94 €	pino
03201-BT	19	10	2,68 €	3,08 €	blanco
03201-WT	19	10	2,56 €	2,94 €	wengué

Soporte Madera
Clásico 30 mm
a Techo

Bracket Ceiling
Classic /
Supportau plafond
Classique



REF	∅	U	€	€ ¹	COLOR
03202-RT	30	10	3,84 €	4,42 €	roble
03202-TT	30	10	3,84 €	4,42 €	teka
03202-PT	30	10	3,84 €	4,42 €	pino
03202-BT	30	10	4,08 €	4,69 €	blanco
03202-WT	30	10	3,84 €	4,42 €	wengué

Tirador madera
1 m

Wand /
Bâton

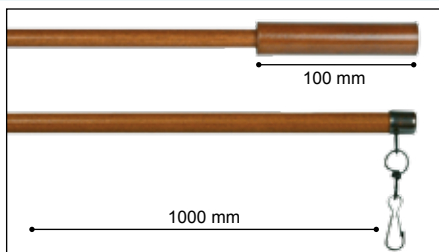

REF	∅	U	€	€ ¹	COLOR
03202-RTI		1		7,60 €	roble
03202-TTI		1		7,60 €	teka
03202-PTI		1		7,60 €	pino
03202-BTI		1		8,50 €	blanco
03202-WTI		1		7,60 €	wengué

Barra color Roble

Oak Color Pole /
Tringle /
Couleur Chêne



REF	∅	U	€	€ ¹	cm
03201-R120	19	10	6,82 €	7,84 €	120
03201-R160	19	10	9,10 €	10,47 €	160
03201-R200	19	10	11,36 €	13,06 €	200
03201-R240	19	10	13,64 €	15,69 €	240
03202-R120	30	10	10,48 €	12,05 €	120
03202-R160	30	10	13,96 €	16,05 €	160
03202-R200	30	10	17,48 €	20,10 €	200
03202-R240	30	10	21,00 €	24,15 €	240

ECLIPSE

Accesorios /
Accessories /
Accessoires

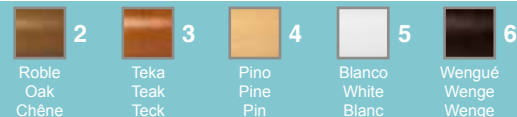

Barra color Teka

Teak Color Pole /
Tringle
Couleur Teck



REF	∅				
03201-T120	19	10	6,82 €	7,84 €	120
03201-T160	19	10	9,10 €	10,47 €	160
03201-T200	19	10	11,36 €	13,06 €	200
03201-T240	19	10	13,64 €	15,69 €	240
03202-T120	30	10	10,48 €	12,05 €	120
03202-T160	30	10	13,96 €	16,05 €	160
03202-T200	30	10	17,48 €	20,10 €	200
03202-T240	30	10	21,00 €	24,15 €	240

Barra color Pino

pine Color Pole /
Tringle
Couleur Pin



REF	∅				
03201-P120	19	10	6,82 €	7,84 €	120
03201-P160	19	10	9,10 €	10,47 €	160
03201-P200	19	10	11,36 €	13,06 €	200
03201-P240	19	10	13,64 €	15,69 €	240
03202-P120	30	10	10,48 €	12,05 €	120
03202-P160	30	10	13,96 €	16,05 €	160
03202-P200	30	10	17,48 €	20,10 €	200
03202-P240	30	10	21,00 €	24,15 €	240

Barra color Blanco

White Color Pole /
Tringle
Couleur Blanc

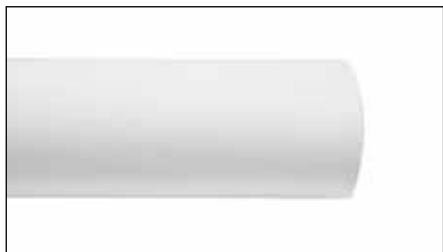

REF	∅				
03201-B120	19	10	7,58 €	8,72 €	120
03201-B160	19	10	10,10 €	11,62 €	160
03201-B200	19	10	12,62 €	14,51 €	200
03201-B240	19	10	15,12 €	17,39 €	240
03202-B120	30	10	11,62 €	13,36 €	120
03202-B160	30	10	15,50 €	17,83 €	160
03202-B200	30	10	19,40 €	22,31 €	200
03202-B240	30	10	23,28 €	26,77 €	240

Barra color Wengué

Wenge Color Pole /
Tringle
Couleur Wenge



REF	∅				
03201-W120	19	10	7,58 €	8,72 €	120
03201-W160	19	10	10,10 €	11,62 €	160
03201-W200	19	10	12,62 €	14,51 €	200
03201-W240	19	10	15,12 €	17,39 €	240
03202-W120	30	10	11,62 €	13,36 €	120
03202-W160	30	10	15,50 €	17,83 €	160
03202-W200	30	10	19,40 €	22,31 €	200
03202-W240	30	10	23,28 €	26,77 €	240

Expositor
ECLIPSE

ECLIPSE
Display Board /
Presentoir
ECLIPSE



REF	∅				
M.209		1		42,60 €	

El perfecto equilibrio
entre material y diseño



Marvent
SOLUCIONES PARA DECORAR VENTANAS

SERIE PRESTIGE

Presentamos la colección "Prestige" en dos series:

- Romantic en colores clásicos
- Neons en colores vivos y alegres

*Colección bajo pedido

PORTAVISILLOS

Portavisillos / Net Curtain Rod / Petit Tringles

Frankfurt Ø8mm



Blanco
White / Blanc

Café Ø12 mm



Latón
Brass/ Laiton



Blanco
White / Blanc

Berlín Ø10 mm



Blanco
White / Blanc

Bonn Ø8 mm



Negro Óxido
Black-Rust/Noir-roui Ilé



Negro Oro
Black-Gold/Noir-Or



Negro
Black / Noir

Praga Ø9 mm



Acero
Steel / Acier



Negro
Black / Noir



Latón
Brass/ Laiton



Blanco
White / Blanc

Ø 8 / 9 / 10 / 12 mm

Portavisillos / Net Curtain Rod / Petit Tringles

Frankfurt Ø 8 mm - Portavisillo blanco Extensible / White Extensible Net Rod / Petite Tringle Blanche Extensible



REF				
46477-1830	10	1,54 €	1,77 €	18-30
46477-3055	10	1,62 €	1,86 €	30-55
46477-5595	10	2,20 €	2,53 €	53-95

Café Ø 12 mm - Portavisillo blanco Extensible / White Extensible Net Rod / Petite Tringle Blanche Extensible



REF				
46475-B5085	10	4,80 €	5,52 €	50-85
46475-B75135	10	5,80 €	6,67 €	75-135
46475-B125235	10	7,56 €	8,69 €	125-235
46475-O5085	10	5,44 €	6,26 €	50-85
46475-O75135	10	6,64 €	7,64 €	75-135
46475-O125235	10	8,72 €	10,03 €	125-235

Soporte
Café

Bracket /
Support



REF	∅				
46475-F3		50	0,66 €	0,76 €	
46475-F4		50	0,44 €	0,51 €	

*Soporte incluido en el Kit / Bracket included in the Kit / Support inclus dans le Kit

Berlín Ø 10 mm - Portavisillo blanco Extensible / White Extensible Net Rod / Petite Tringle Blanche Extensible



REF				
46478-4070	25	0,82 €	0,94 €	40-70
46478-6011	25	1,16 €	1,33 €	60-110
46478-80150	25	1,46 €	1,68 €	80-150

*Se sirve con Alcatayas / Supplied with 2 Hooks / Fourni avec 2 Clous

Soporte
Autoadhesivo
Berlín

Self-adhesive Hook /
Support Adhesif



REF	∅				
46478-1		100	0,42 €	0,48 €	

Portavisillos / Net Curtain Rod / Petit Tringles

Bonn Ø 8 mm - Portavisillo Extensible Forja / Wrought iron finish Extendible Net curtain Rod / Tringle Extensible fer forgé



*Bajo pedido

Soporte
Autoadhesivo
BonnSelf-adhesive hook /
Support adhesif

*Bajo pedido

REF				
F.004N	50	1,52 €	1,75 €	40-70
F.006N	50	2,10 €	2,42 €	60-110
F.008N	50	2,62 €	3,01 €	80-150
F.004NO	50	1,82 €	2,09 €	40-70
F.006NO	50	2,52 €	2,90 €	60-110
F.008NO	50	3,16 €	3,63 €	80-150
F.004OX	50	1,82 €	2,09 €	40-70
F.006OX	50	2,52 €	2,90 €	60-110
F.008OX	50	3,16 €	3,63 €	80-150

*Se sirve con Alcayatas / Supplied with 2 Hooks / Fourni avec 2 Clous

REF					
F.1N		100	0,42 €	0,48 €	
F.1NO		100	0,50 €	0,58 €	
F.1OX		100	0,50 €	0,58 €	

Praga Ø 9 mm - Portavisillo Extensible / Extendible Net curtain Rod / Tringle Extensible

Blanco
White / BlancNegro
Black / NoirAcero
Steel / AcierLatón
Brass / Laiton

REF				
46476-B2540	10	3,26 €	3,75 €	25-40
46476-B4070	10	4,40 €	5,06 €	40-70
46476-B60110	10	5,60 €	6,44 €	60-110
46476-B80150	10	7,34 €	8,44 €	80-150
46476-N2540	10	3,26 €	3,75 €	25-40
46476-N4070	10	4,40 €	5,06 €	40-70
46476-N60110	10	5,60 €	6,44 €	60-110
46476-N80150	10	7,34 €	8,44 €	80-150
46476-A2540	10	4,22 €	4,85 €	25-40
46476-A4070	10	5,72 €	6,58 €	40-70
46476-A60110	10	8,56 €	9,84 €	60-110
46476-A80150	10	9,96 €	11,45 €	80-150
46476-LA2540	10	4,22 €	4,85 €	25-40
46476-LA4070	10	5,72 €	6,58 €	40-70
46476-LA60110	10	8,56 €	9,84 €	60-110
46476-LA80150	10	9,96 €	11,45 €	80-150

*Se sirve con Alcayatas / Supplied with 2 Hooks / Fourni avec 2 Clous

Portavisillos / Net Curtain Rod / Petit Tringles

Soporte metalizado
Autoadhesivo

Metallic Adhesive
Bracket /
Support Metal Adhesif



	∅	U	€	€ ¹	
46476-BL		100	0,72 €	0,83 €	blanco
46476-N		100	0,72 €	0,83 €	negro
46476-A		100	0,80 €	0,92 €	acero
46476-P		100	0,80 €	0,92 €	plata
46476-LA		100	0,80 €	0,92 €	latonado

Soporte
Autoadhesivo dorado

Self-adhesive
Hook /
Support Adhesif



REF	∅	U	€	€ ¹	cm
F.2		100	0,82 €	0,94 €	

*Bajo pedido

Anillo plástico
12 mm

Plastic ring
12 mm/
Anneau en plastique
12 mm



REF	∅	U	€	€ ¹	COLOR
46476-AC	12 mm	100	0,17 €		cromado
46476-LA	12 mm	100	0,25 €		dorado
46476-BL	12 mm	100	0,14 €		blanco

Barra de Baño / Shower Curtain Rod / Rideau de Douche

Barra de baño
extensible

Extensible shower
curtain rod /
Barre extensible
pour rideau de douche



REF	∅	U	€	€ ¹	cm
90416-B120		10	10,36 €	11,91 €	75 - 120
90416-B240		10	15,06 €	17,32 €	130 - 240

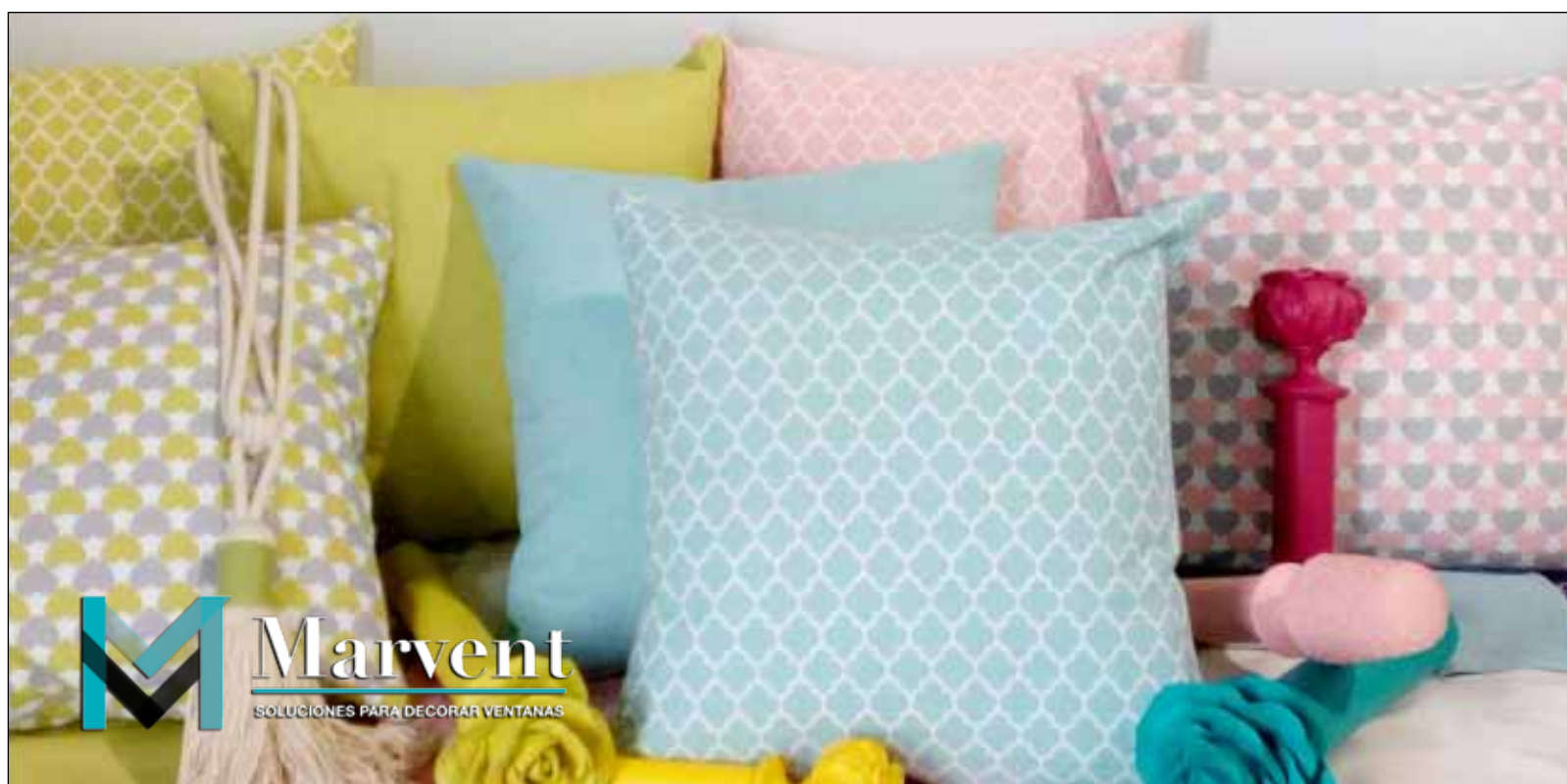

Ponemos a su disposición una amplia gama de fundas de cojín para darle un toque cálido y confortable a su hogar.



Cojín CAT



Cojín Coordinado Orleans



Cojín Elegance



Cojín Everest



Cojín Himalaya



Cojín Hojas



Cojín Love



Cojín Marina



Cojín Marta



Cojín Orleans



Cojín Questions



Cojín Wonder



Marvent

SOLUCIONES PARA DECORAR VENTANAS

Galerías

pelmetes / cantonnières



Marvent

SOLUCIONES PARA DECORAR VENTANAS



GALERÍAS
COLORSYSTEM
PELMETS



Marvent

SOLUCIONES PARA DECORAR VENTANAS

ColorSystem COLOR

Sin separador /
Without divider-bar / Sans separations



Blanco / White / Blanc



Beige / Beige / Beige



Amarillo / Yellow / Jaune



Naranja / Orange / Orange



Rojo / Red / Rouge

Con separador /
With divider-bar / Avec separations



Azul / Blue / Bleu



Violeta / Violet / Violet



Verde / Green / Verd



Negro / Black / Noir

ColorSystem LISA

12 cm. Lisa /
12 cm. Plain / 12 cm. Lisse



Champagne / Champagne / Champagne

ColorSystem METAL

Sin separador / Without divider-bar / Sans separations



Inox / Inox / Inox



Ondas / Waves / Ondes

Con separador / With divider-bar / Avec separations



Inox / Inox / Inox



Ondas / Waves / Ondes

ColorSystem MADERA

Sin separador /
Without divider-bar / Sans separations



Roble/ Oak / Chêne



Cebrano claro / Light zebrano / Zebrano llair



Cebrano oscuro / Dark zebrano / Zebrano sombré

Con separador / With divider-bar / Avec separations



Wengué / Wenge / Wenge



Cerezo / Cherri / Merisier

Conjuntos completos ColorSystem **LISA 12cm** /
 Complet sets ColorSystem **PLAIN 12cm** /
 Kits complete ColorSystem **LISSE 12cm**

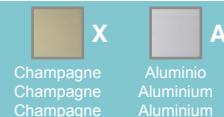

Galería ColorSystem 12cm Champagne Lisa / ColorSystem Pelmet 12 cm Plain Champagne / Cantonnière ColorSystem 12cm Champagne Lisse



REF	U	€	cm
40296-MX100	1	43,78 €	100
40296-MX150	1	54,96 €	150
40296-MX200	1	68,51 €	200
40296-MX250	1	79,69 €	250
40296-MX300	1	93,23 €	300
40296-MX350	1	114,14 €	350
40296-MX400	1	125,32 €	400
40296-MX450	1	136,50 €	450
40296-MX500	1	147,67 €	500
40296-MX550	1	158,85 €	550
40296-MX600	1	174,77 €	600

Galería ColorSystem 12cm Aluminio Lisa / ColorSystem Pelmet 12 cm Plain Aluminium / Cantonnière ColorSystem 12cm Aluminium Lisse



REF	U	€	cm
40296-MA100	1	35,16 €	100
40296-MA150	1	43,72 €	150
40296-MA200	1	54,66 €	200
40296-MA250	1	63,23 €	250
40296-MA300	1	74,16 €	300
40296-MA350	1	91,54 €	350
40296-MA400	1	100,11 €	400
40296-MA450	1	108,68 €	450
40296-MA500	1	117,24 €	500
40296-MA550	1	125,81 €	550
40296-MA600	1	139,12 €	600

Contenido del Kit / Kit components / Composants du Kit

La medida es la suma del frontal y los laterales.
 A partir de 3 m las galerías van empalmadas.
 Se debe proporcionar la medida exterior.
 La medida exterior es igual a la superficie que necesita cubrir más 4 cm mínimo adicionales.
 (4 cm = 1,7 cm x 2 de codos y/o esquinas + espacio para trabajar).

For sizes more than 3 m pelmets are spliced.
 Sizes required are outer measures.
 The outer measure is equal to the area you need to cover plus 4 cm minimum.
 (4 cm = 1.7 cm x 2 elbows and / or corners + workspace).

Pour les tailles plus de 3 m les cantonnières sont épissés.
 Tailles nécessaires sont des mesures extérieures.
 La mesure extérieur est égale à la surface dont vous avez besoin pour couvrir plus un minimum de 4 cm.
 (4 cm = 1,7 cm x 2 coudes et / ou des coins + espace de travail).

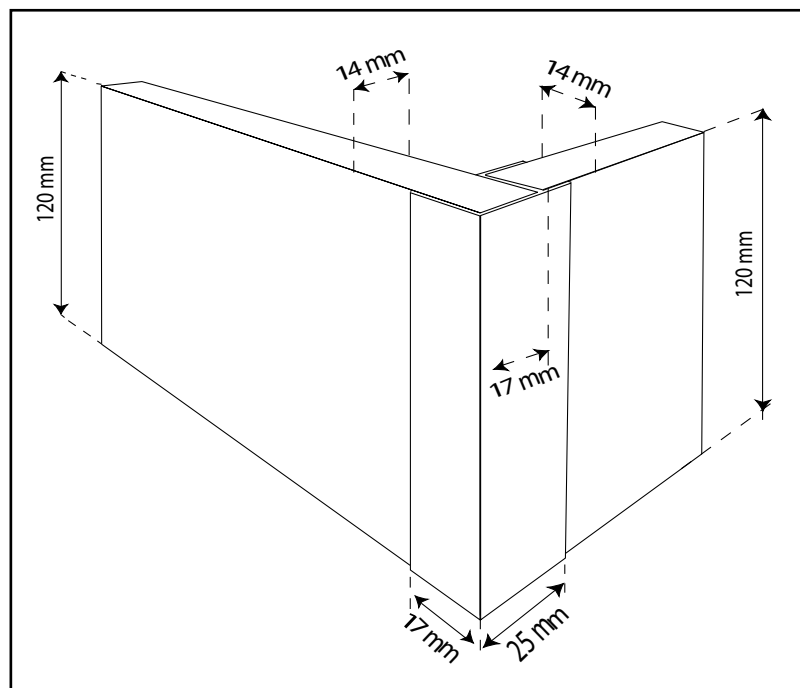

GALERÍA COLORSYSTEM

Conjuntos completos ColorSystem 12cm /
 Complet sets ColorSystem COLOR 12 cm /
 Kits complete ColorSystem COLOR 12 cm

102	000	001	002	004	005	006	010	103
Blanco White Blanc	Beige Beige Beige	Amarillo Yellow Jaune	Naranja Orange Orange	Rojo Red Rouge	Azul Blue Bleu	Violeta Violet Violette	Verde Green Vert	Negro Black Noir

Galería ColorSystem SIN Separador / ColorSystem Pelmet WITHOUT divider-bar / Cantonnière ColorSystem SANS séparation



REF			
K.31100C	1	47,14 €	100
K.31150C	1	61,53 €	150
K.31200C	1	87,56 €	200
K.31250C	1	97,17 €	250
K.31300C	1	109,15 €	300
K.31350C	1	155,66 €	350
K.31400C	1	165,27 €	400
K.31450C	1	174,89 €	450
K.31500C	1	184,50 €	500
K.31550C	1	194,12 €	550
K.31600C	1	208,47 €	600

Galería ColorSystem CON Separador / ColorSystem Pelmet WITH divider-bar / Cantonnière ColorSystem AVEC séparation



REF			
K.32100C	1	50,24 €	100
K.32150C	1	65,89 €	150
K.32200C	1	93,69 €	200
K.32250C	1	104,30 €	250
K.32300C	1	117,27 €	300
K.32350C	1	166,35 €	350
K.32400C	1	176,95 €	400
K.32450C	1	187,56 €	450
K.32500C	1	198,16 €	500
K.32550C	1	208,76 €	550
K.32600C	1	224,10 €	600

Contenido del Kit / Kit components / Composants du Kit

La medida es la suma del frontal y los laterales.

A partir de 3 m las galerías van empalmadas.
 Se debe proporcionar la medida exterior.
 La medida exterior es igual a la superficie que necesita cubrir más
 4 cm mínimo adicionales.
 (4 cm = 1,7 cm x 2 de codos y/o esquinas + espacio para trabajar).

For sizes more than 3 m pelmets are spliced.

Sizes required are outer measures.
 The outer measure is equal to the area you need to cover plus
 4 cm minimum.
 (4 cm = 1.7 cm x 2 elbows and / or corners + workspace).

Pour les tailles plus de 3 m les cantonnières sont épissés.

Tailles nécessaires sont des mesures extérieures.
 La mesure extérieur est égale à la surface dont vous avez besoin
 pour couvrir plus un minimum de 4 cm.
 (4 cm = 1,7 cm x 2 coudes et / ou des coins + espace de travail).

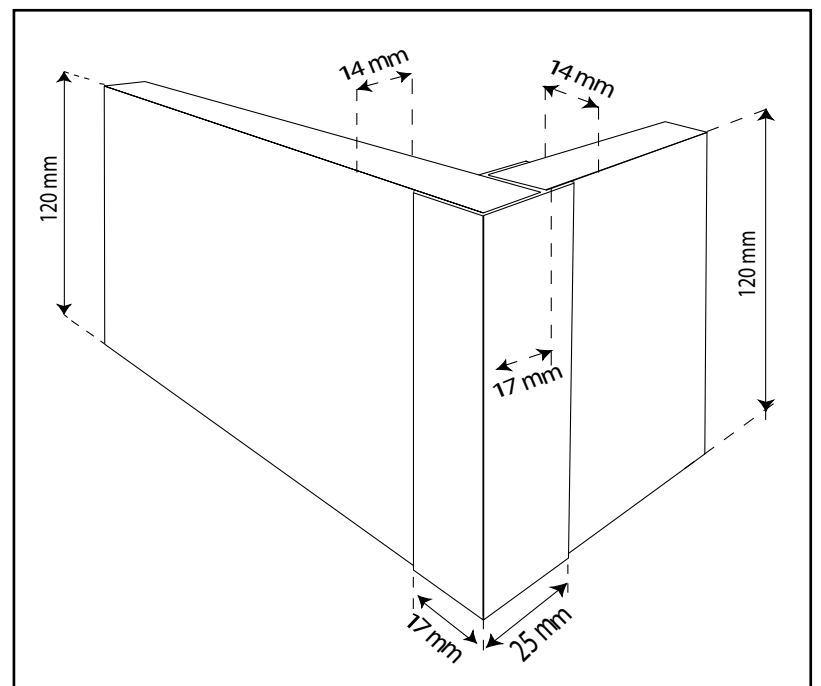

Conjuntos completos ColorSystem **MADERA 12 cm** /
 Complet sets ColorSystem **WOOD 12 cm** /
 Kits complete ColorSystem **BOIS 12 cm**

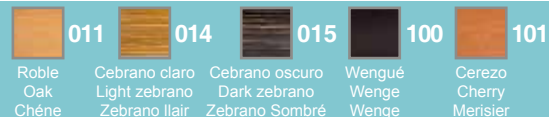

Galería ColorSystem **SIN Separador** / ColorSystem Pelmet **WITHOUT divider-bar** / Cantonnière ColorSystem **SANS séparation**



REF	U	€	cm
K.31100M	1	50,42 €	100
K.31150M	1	66,49 €	150
K.31200M	1	97,47 €	200
K.31250M	1	107,08 €	250
K.31300M	1	119,07 €	300
K.31350M	1	175,49 €	350
K.31400M	1	185,10 €	400
K.31450M	1	194,71 €	450
K.31500M	1	204,33 €	500
K.31550M	1	213,94 €	550
K.31600M	1	228,29 €	600

Galería ColorSystem **CON Separador** / ColorSystem Pelmet **WITH divider-bar** / Cantonnière ColorSystem **AVEC séparation**



REF	U	€	cm
K.32100M	1	53,46 €	100
K.32150M	1	70,76 €	150
K.32200M	1	103,44 €	200
K.32250M	1	114,05 €	250
K.32300M	1	127,02 €	300
K.32350M	1	185,85 €	350
K.32400M	1	196,46 €	400
K.32450M	1	207,06 €	450
K.32500M	1	217,66 €	500
K.32550M	1	228,27 €	550
K.32600M	1	243,61 €	600

Contenido del Kit / Kit components / Composants du Kit

La medida es la suma del frontal y los laterales.
 A partir de 3 m las galerías van empalmadas.
 Se debe proporcionar la medida exterior.
 La medida exterior es igual a la superficie que necesita cubrir más 4 cm mínimo adicionales.
 (4 cm = 1,7 cm x 2 de codos y/o esquinas + espacio para trabajar).

For sizes more than 3 m pelmets are spliced.
 Sizes required are outer measures.
 The outer measure is equal to the area you need to cover plus 4 cm minimum.
 (4 cm = 1.7 cm x 2 elbows and / or corners + workspace).

Pour les tailles plus de 3 m les cantonnières sont épissés.
 Tailles nécessaires sont des mesures extérieures.
 La mesure extérieur est égale à la surface dont vous avez besoin pour couvrir plus un minimum de 4 cm.
 (4 cm = 1,7 cm x 2 coudes et / ou des coins + espace de travail).

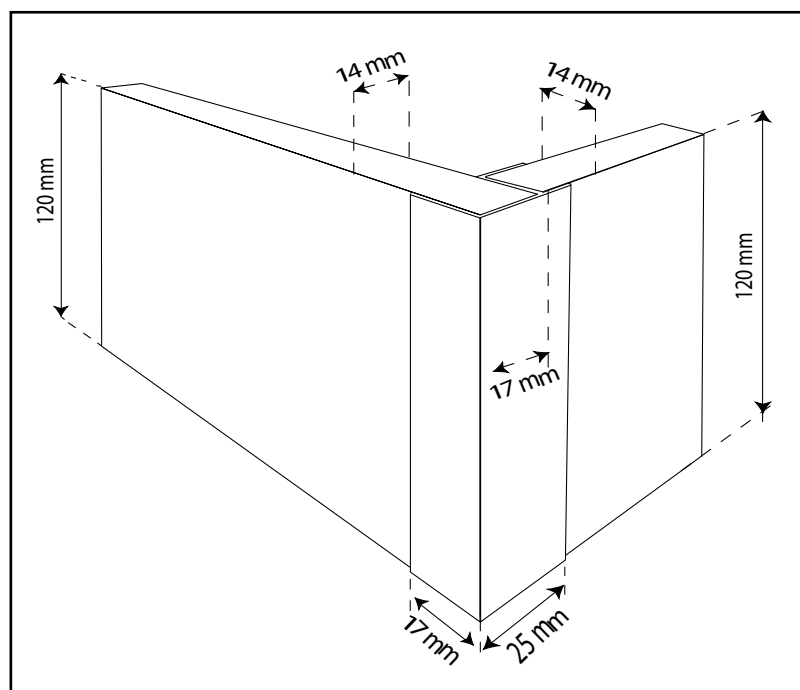

GALERÍA COLORSYSTEM

Conjuntos completos ColorSystems METAL 12 cm /
 Complet sets ColorSystem METAL 12 cm /
 Kits complete ColorSystem METAL 12 cm



Galería ColorSystem SIN Separador / ColorSystem Pelmet WITHOUT divider-bar / Cantonnière ColorSystem SANS séparation



REF			
K.31100A	1	72,45 €	100
K.31150A	1	99,87 €	150
K.31200A	1	164,24 €	200
K.31250A	1	173,85 €	250
K.31300A	1	185,84 €	300
K.31350A	1	309,02 €	350
K.31400A	1	318,64 €	400
K.31450A	1	328,25 €	450
K.31500A	1	337,87 €	500
K.31550A	1	347,48 €	550
K.31600A	1	361,83 €	600

Galería ColorSystem CON Separador / ColorSystem Pelmet WITH divider-bar / Cantonnière ColorSystem AVEC séparation



REF			
K.32100A	1	75,21 €	100
K.32150A	1	103,72 €	150
K.32200A	1	169,36 €	200
K.32250A	1	179,97 €	250
K.32300A	1	192,94 €	300
K.32350A	1	317,69 €	350
K.32400A	1	328,29 €	400
K.32450A	1	338,90 €	450
K.32500A	1	349,50 €	500
K.32550A	1	360,10 €	550
K.32600A	1	375,44 €	600

Contenido del Kit / Kit components / Composants du Kit

La medida es la suma del frontal y los laterales.

A partir de 3 m las galerías van empalmadas.
 Se debe proporcionar la medida exterior.
 La medida exterior es igual a la superficie que necesita cubrir más
 4 cm mínimo adicionales.
 (4 cm = 1,7 cm x 2 de codos y/o esquinas + espacio para trabajar).

For sizes more than 3 m pelmets are spliced.

Sizes required are outer measures.
 The outer measure is equal to the area you need to cover plus
 4 cm minimum.
 (4 cm = 1.7 cm x 2 elbows and / or corners + workspace).





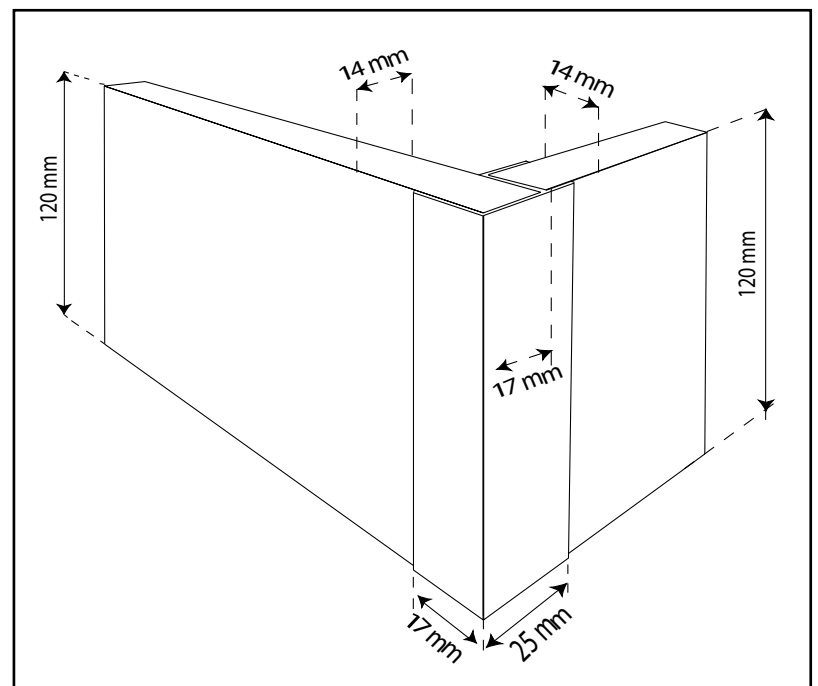

Pour les tailles plus de 3 m les cantonnières sont épissés.

Tailles nécessaires sont des mesures extérieures.
 La mesure extérieur est égale à la surface dont vous avez besoin
 pour couvrir plus un minimum de 4 cm.
 (4 cm = 1,7 cm x 2 coudes et / ou des coins + espace de travail).

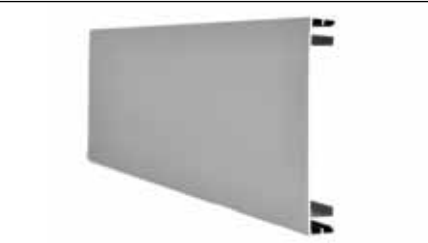

Accesorios / Accessories / Accessoires

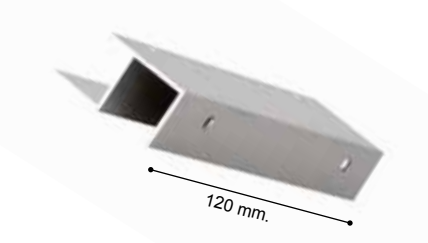
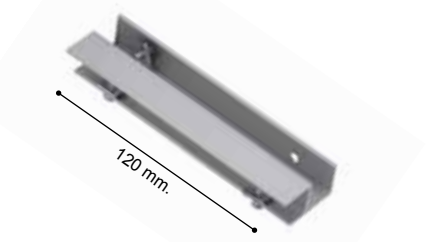

<p>Pefil separador Divider-bar / Separateur en alu- minium</p>		<table border="1"> <thead> <tr> <th>REF</th> <th>∅</th> <th>U</th> <th>€</th> <th>€</th> <th>cm</th> </tr> </thead> <tbody> <tr> <td>C.12028AP</td> <td></td> <td>60</td> <td>1,72 €</td> <td>1,98 €</td> <td></td> </tr> </tbody> </table>	REF	∅	U	€	€	cm	C.12028AP		60	1,72 €	1,98 €							
REF	∅	U	€	€	cm															
C.12028AP		60	1,72 €	1,98 €																
<p>Pefil galería con separador 12 cm. Profile with divider-bar 12 cm / Rail avec séparation 12 cm</p>		<table border="1"> <thead> <tr> <th>REF</th> <th>∅</th> <th>U</th> <th>€</th> <th>€</th> <th>cm</th> </tr> </thead> <tbody> <tr> <td>C.12027AP</td> <td></td> <td>60</td> <td>16,72 €</td> <td>19,23 €</td> <td></td> </tr> </tbody> </table>	REF	∅	U	€	€	cm	C.12027AP		60	16,72 €	19,23 €							
REF	∅	U	€	€	cm															
C.12027AP		60	16,72 €	19,23 €																
<p>Pefil galería sin separador Lisa 12 cm. Profile without divider-bar 12 cm / Rail sans séparation 12 cm</p>		<table border="1"> <thead> <tr> <th>REF</th> <th>∅</th> <th>U</th> <th>€</th> <th>€</th> <th>cm</th> </tr> </thead> <tbody> <tr> <td>40296-12026AP</td> <td></td> <td>60</td> <td>14,90 €</td> <td>17,14 €</td> <td></td> </tr> <tr> <td>40296-12026X</td> <td></td> <td>60</td> <td>19,44 €</td> <td>22,36 €</td> <td>NEW</td> </tr> </tbody> </table>	REF	∅	U	€	€	cm	40296-12026AP		60	14,90 €	17,14 €		40296-12026X		60	19,44 €	22,36 €	NEW
REF	∅	U	€	€	cm															
40296-12026AP		60	14,90 €	17,14 €																
40296-12026X		60	19,44 €	22,36 €	NEW															
<p>Empalme Splice / Raccordeur</p>		<table border="1"> <thead> <tr> <th>REF</th> <th>∅</th> <th>U</th> <th>€</th> <th>€</th> <th>cm</th> </tr> </thead> <tbody> <tr> <td>40296-200AP</td> <td></td> <td>10</td> <td>3,54 €</td> <td>4,07 €</td> <td></td> </tr> <tr> <td>40296-200X</td> <td></td> <td>10</td> <td>4,34 €</td> <td>4,99 €</td> <td>NEW</td> </tr> </tbody> </table>	REF	∅	U	€	€	cm	40296-200AP		10	3,54 €	4,07 €		40296-200X		10	4,34 €	4,99 €	NEW
REF	∅	U	€	€	cm															
40296-200AP		10	3,54 €	4,07 €																
40296-200X		10	4,34 €	4,99 €	NEW															
<p>Esquina Outer joint / Coude extérieur</p>		<table border="1"> <thead> <tr> <th>REF</th> <th>∅</th> <th>U</th> <th>€</th> <th>€</th> <th>cm</th> </tr> </thead> <tbody> <tr> <td>40296-201AP</td> <td></td> <td>10</td> <td>3,54 €</td> <td>4,07 €</td> <td></td> </tr> <tr> <td>40296-201X</td> <td></td> <td>10</td> <td>4,34 €</td> <td>4,99 €</td> <td>NEW</td> </tr> </tbody> </table>	REF	∅	U	€	€	cm	40296-201AP		10	3,54 €	4,07 €		40296-201X		10	4,34 €	4,99 €	NEW
REF	∅	U	€	€	cm															
40296-201AP		10	3,54 €	4,07 €																
40296-201X		10	4,34 €	4,99 €	NEW															
<p>Rincón Inner joint / Coude intérieur</p>		<table border="1"> <thead> <tr> <th>REF</th> <th>∅</th> <th>U</th> <th>€</th> <th>€</th> <th>cm</th> </tr> </thead> <tbody> <tr> <td>40296-202AP</td> <td></td> <td>10</td> <td>3,54 €</td> <td>4,07 €</td> <td></td> </tr> <tr> <td>40296-202X</td> <td></td> <td>10</td> <td>4,34 €</td> <td>4,99 €</td> <td>NEW</td> </tr> </tbody> </table>	REF	∅	U	€	€	cm	40296-202AP		10	3,54 €	4,07 €		40296-202X		10	4,34 €	4,99 €	NEW
REF	∅	U	€	€	cm															
40296-202AP		10	3,54 €	4,07 €																
40296-202X		10	4,34 €	4,99 €	NEW															
<p>SopORTE Techo Ceiling Bracket / Support Plafond</p>		<table border="1"> <thead> <tr> <th>REF</th> <th>∅</th> <th>U</th> <th>€</th> <th>€</th> <th>cm</th> </tr> </thead> <tbody> <tr> <td>40296-D50</td> <td></td> <td>50</td> <td>2,06 €</td> <td>2,37 €</td> <td></td> </tr> </tbody> </table> <p>* Soporte incluido en el kit / Bracket supplied in the kit / Support fourni dans le kit.</p>	REF	∅	U	€	€	cm	40296-D50		50	2,06 €	2,37 €							
REF	∅	U	€	€	cm															
40296-D50		50	2,06 €	2,37 €																
<p>Muestra GALERÍA PELMET Sample / Presentoir</p>		<table border="1"> <thead> <tr> <th>REF</th> <th>∅</th> <th>U</th> <th>€</th> <th>€</th> <th>cm</th> </tr> </thead> <tbody> <tr> <td>M.312</td> <td></td> <td>1</td> <td></td> <td>11,22 €</td> <td>NEW</td> </tr> </tbody> </table>	REF	∅	U	€	€	cm	M.312		1		11,22 €	NEW						
REF	∅	U	€	€	cm															
M.312		1		11,22 €	NEW															

Accesorios / Accessories / Accessoires

Muestra Colores
GALERÍAPELMET
Color Sample /
Presentoir Colour
Cantonnière

REF	Ø				
M.7		1		21,42 €	

Muestra GALERÍA
COLORSYSTEMPELMET
COLORSYSTEM
Sample /
Presentoir
COLORSYSTEM
Cantonnière

REF	Ø				
M.310		1		21,42 €	

Láminas ColorSystem 12 cm COLOR / Bars ColorSystem 12 cm COLOR / Séparation ColorSystem 12 cm COLEUR

COLOR	REF										
102	V.102CO_	10	115	25,14 €	28,91 €	92	19,74 €	22,70 €	22	6,80 €	7,82 €
000	V.000CO_	10	115	24,42 €	28,08 €	92	19,18 €	22,06 €	22	6,62 €	7,61 €
001	V.001CO_	10	115	24,42 €	28,08 €	92	19,18 €	22,06 €	22	6,62 €	7,61 €
002	V.002CO_	10	115	24,42 €	28,08 €	92	19,18 €	22,06 €	22	6,62 €	7,61 €
004	V.004CO_	10	115	24,42 €	28,08 €	92	19,18 €	22,06 €	22	6,62 €	7,61 €
005	V.005CO_	10	115	24,42 €	28,08 €	92	19,18 €	22,06 €	22	6,62 €	7,61 €
006	V.006CO_	10	115	24,42 €	28,08 €	92	19,18 €	22,06 €	22	6,62 €	7,61 €
010	V.010CO_	10	115	24,42 €	28,08 €	92	19,18 €	22,06 €	22	6,62 €	7,61 €
103	V.103CO_	10	115	25,14 €	28,91 €	92	19,74 €	22,70 €	22	6,80 €	7,82 €

Láminas ColorSystem 12 cm MADERA / Bars ColorSystem 12 cm WOOD / Séparation ColorSystem 12 cm BOIS

COLOR	REF										
011	V.011CO_	10	115	33,04 €	38,00 €	92	25,80 €	29,67 €	22	8,48 €	9,75 €
014	V.014CO_	10	115	33,04 €	38,00 €	92	25,80 €	29,67 €	22	8,48 €	9,75 €
015	V.015CO_	10	115	33,04 €	38,00 €	92	25,80 €	29,67 €	22	8,48 €	9,75 €
100	V.100CO_	10	115	33,04 €	38,00 €	92	25,80 €	29,67 €	22	8,48 €	9,75 €
101	V.101CO_	10	115	33,04 €	38,00 €	92	25,80 €	29,67 €	22	8,48 €	9,75 €

Láminas ColorSystem 12 cm METAL / Bars ColorSystem 12 cm METAL / Séparation ColorSystem 12 cm MÉTAL

COLOR	REF										
016	V.016CO_	10	115	91,10 €	104,77 €	92	70,48 €	81,05 €	22	21,12 €	24,29 €
017	V.017CO_	10	115	91,10 €	104,77 €	92	70,48 €	81,05 €	22	21,12 €	24,29 €

Los precios están indicados para láminas con una longitud total de 3050mm. /

Prices shown include laminates up to 3050mm. long. /

Les prix sont indiqués pour laminés jusqu'à 3050mm. de longueur.

Galería de Madera 10 cm / Wood Pelmet 10 cm / Cantonnière en Bois 10 cm



Wengué / Wenge / Wenge



Cerezo / Cherry / Merisier



Roble blanco / White oak / Chêne blanc



Plata mate / Matt nickel / Nickel satiné



Roble / Oak / Chêne



Gris ceniza / Ash grey / Gris cendre

Precios de Galerías montadas

REF	COLOR	180	240	360	4,8
40297-MP (medida)	plata mate	68,45 €	79,05 €	90,84 €	128,69 €
40297-MC (medida)	cerezo	56,65 €	63,28 €	74,2 €	110,08 €
40297-MW (medida)	wengué	56,65 €	63,28 €	74,2 €	110,08 €
40297-MG (medida)	gris ceniza	56,65 €	63,28 €	74,2 €	110,08 €
40297-MRO (medida)	roble	56,65 €	63,28 €	74,2 €	110,08 €
40297-MRB (medida)	roble-blanco	56,65 €	63,28 €	74,2 €	110,08 €

 Perfil y 2 esquinas (La medida es la suma del frontal y los laterales).

10 cm

GALERÍA MADERA

Perfil Galería Madera 10 cm /
Wood Pelmet Profile 10 cm /
Cantonnière Rail Bois 10 cm



Wengué / Wenge / Wenge



REF				
40297-W244	10	20,60 €	23,69 €	244
40297-W366	10	30,70 €	35,31 €	366

Roble blanco / White Oak / Chêne Blanc



REF				
40297-RB244	10	20,60 €	23,69 €	244
40297-RB366	10	30,70 €	35,31 €	366

Roble / Oak / Chêne



REF				
40297-RO244	10	20,60 €	23,69 €	244
40297-RO366	10	30,70 €	35,31 €	366

Cerezo / Cherry / Cerise



REF				
40297-C244	10	20,60 €	23,69 €	244
40297-C366	10	30,70 €	35,31 €	366

Plata mate / Matt Nickel / Nickel Satiné



REF				
40297-P244	10	27,30 €	31,40 €	244
40297-P366	10	40,94 €	47,08 €	366

Perfil Galería Madera 10 cm /
Wood Pelmet Profile 10 cm /
Cantonnière Rail Bois 10 cm

 W	 RB	 RO	 C	 P	 G
Wengue Wenge Wenge	Roble Blanco White Oak Chêne Blanc	Roble Oak Chêne	Cerezo Cherry Merisier	Plata Mate Matt Nickel Nickel Satiné	Gris Ceniza Ash Grey Gris Cendre

Gris Ceniza / Ash Grey / Gris Cendre



REF				
40297-G244	10	20,60 €	23,69 €	244
40297-G366	10	30,70 €	35,31 €	366





Contenido del Kit / Kit components / Composants du Kit

 Perfil de madera, 2 codos esquina y escuadra.

Accesorios / Accessories / Accessoires





Escuadra
Caja 100 u
Bracket 100 u /
Support 100 u

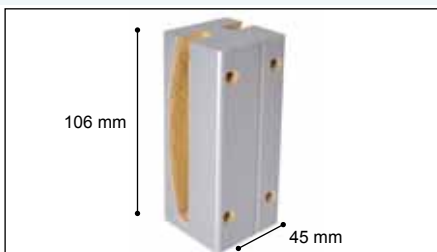

REF					
40297-ES		1		42,20 €	





Empalme
Splice /
Raccordeur

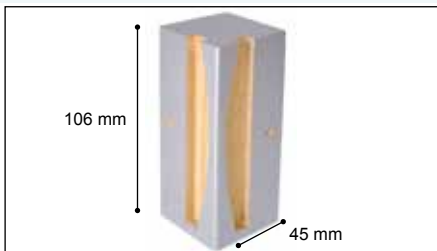

REF					
40297-WU		10	20,72 €	23,83 €	
40297-RBU		10	20,72 €	23,83 €	
40297-ROU		10	20,72 €	23,83 €	
40297-GU		10	20,72 €	23,83 €	
40297-CU		10	20,72 €	23,83 €	
40297-PU		10	20,72 €	23,83 €	





Codo rincón
Inner joint /
Coude Intérieur

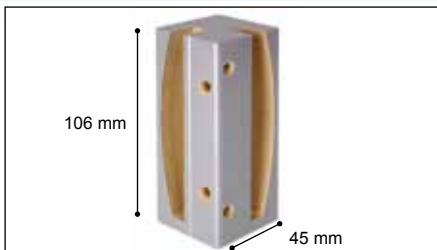

REF					
40297-WES		10	17,18 €	19,76 €	
40297-RBES		10	17,18 €	19,76 €	
40297-ROES		10	17,18 €	19,76 €	
40297-GES		10	17,18 €	19,76 €	
40297-CES		10	17,18 €	19,76 €	
40297-PES		10	17,18 €	19,76 €	





Codo esquina
Outer joint /
Coude extérieur



REF					
40297-WCO		10	16,96 €	19,50 €	
40297-RBCO		10	16,96 €	19,50 €	
40297-ROCO		10	16,96 €	19,50 €	
40297-GCO		10	16,96 €	19,50 €	
40297-CCO		10	16,96 €	19,50 €	
40297-PCO		10	16,96 €	19,50 €	

Muestra
GALERÍA MADERA
Demo sample
WOOD PELMET /
Echantillon
Cantonnière BOIS



REF					
M.6		1		21,42 €	

Galería 10cm Aluminio / Aluminium Pelmet 10cm / Cantonnière Aluminium 10 cm

Conjuntos completos Galería Aluminio 10 cm /
Aluminium Pelmet Complet sets 10 cm /
Kits complete Cantonnière en Aluminium 10 cm

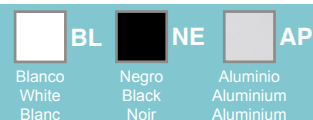

Galería 10 cm



REF ALUMINIO	REF BLANCO	REF NEGRO			
40295-MP100	40295-MB100	40295-MN100	1	25,21 €	100
40295-MP150	40295-MB150	40295-MN150	1	31,72 €	150
40295-MP200	40295-MB200	40295-MN200	1	38,23 €	200
40295-MP250	40295-MB250	40295-MN250	1	44,74 €	250
40295-MP300	40295-MB300	40295-MN300	1	51,24 €	300
40295-MP350	40295-MB350	40295-MN350	1	61,66 €	350
40295-MP400	40295-MB400	40295-MN400	1	68,17 €	400
40295-MP500	40295-MB500	40295-MN500	1	81,19 €	500
40295-MP600	40295-MB600	40295-MN600	1	94,20 €	600

Contenido del Kit / Kit components / Composants du Kit

Perfil de aluminio y 2 esquinas.

La medida es la suma del frontal y los laterales.

Accesorios / Accesories / Accessoires

Perfil de aluminio
10 cm

Aluminium
Profile /
Rail aluminium



REF	\emptyset					COLOR
40295-A600		60	11,32 €	13,02 €		aluminio
40295-B600		60	11,32 €	13,02 €		blanco
40295-N600		60	11,32 €	13,02 €		negro

Esquina 10cm

Outer joint /
Coude extérieur

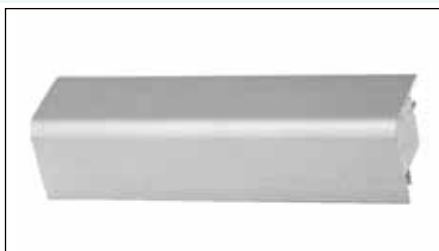

REF	\emptyset					COLOR
40295-AES		10	5,30 €	6,10 €		aluminio
40295-BES		10	5,30 €	6,10 €		blanco
40295-NES		10	5,30 €	6,10 €		negro

Rincón 10cm

Inner joint /
Coude intérieur



REF	\emptyset					COLOR
40295-ACI		10	5,30 €	6,10 €		aluminio
40295-BCI		10	5,30 €	6,10 €		blanco
40295-NCI		10	5,30 €	6,10 €		negro

Muestra
GALERÍA 10 CM

Demo sample
10 cm PELMET /
Echantillon
Cantonnière 10 cm



REF	\emptyset					
M.5		1		10,72 €		

Perfil para BANDÓ / Pelmet rails / Rails pour cantonnières

STAR: Perfil de aluminio velcrado (15x23 mm) / Pelmet rail with bonded velcro / Rail velcro pour cantonnière



REF				COLOR
22610-P2015	60 m	3,64 €/m		plata
22610-B2015	60 m	3,64 €/m		blanco

* Perfil STAR, con cinta cierre para colocar a techo o pared. / STAR pelmet rail, with bonded Touch&close fastener tape for ceiling or wall fixing. / Cantonniere STAR avec ruban adhesif pour fixation plafond ou murale.

*Solo se vende en unidad de embalaje

CLASSIC: Perfil de aluminio velcrado (15x23 mm) / Pelmet rail with bonded velcro / Rail velcro pour cantonnière



REF				
22611-B600	60 m	4,86 €/m	5,83 €/m	600

Accesorios / Accesories / Accessoires

Soporte de plástico

Plastic bracket / Support plastique



REF					
D.29		50	0,66 €	0,79 €	

Soporte articulado de plástico

Articulated plastic bracket / Support plastique articulé



REF					
22611-02		50	1,02 €	1,22 €	

Empalme

Splice / Raccordeur



REF					
D.300		50	1,12 €	1,34 €	

Muestra BANDÓ

BANDÓ Demo sample / Echantillon BANDÓ

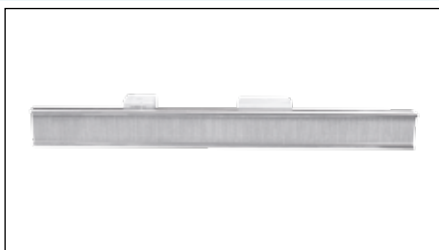

REF					
M.308		1		10,72 €	



Rieles Manuales

hard-drawn curtain tracks / rails manuelles

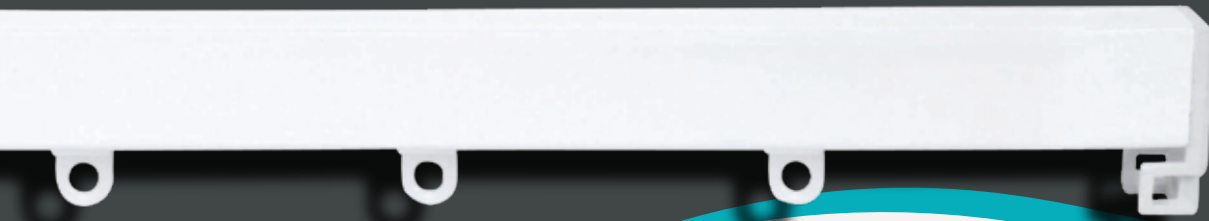

Marvent

SOLUCIONES PARA DECORAR VENTANAS



RIEL TÉCNICO TRIM

TECHNICAL RAIL TRIM



**Solución profesional para el hogar de máxima resistencia y seguridad.
Por ello, se emplea también en la construcción de hospitales.**

Professional solution for the maximum resistance and security.
It is therefore used for hospital building.



TRIM Riel Manual / Hand-Drawn Track TRIM / Rail Manuelle TRIM



TRIM MANUAL Conjuntos completos con soporte a techo (20615-04) Corredera ref. 23643-07	REF	Soportes Brackets Supports	Correderas Gliders Glisseur				
	22615-YMB100	2	10	10	8,82 €	10,14 €	100
22615-YMB125	2	12	10	9,58 €	11,00 €	125	
22615-YMB150	3	16	10	10,02 €	11,53 €	150	
22615-YMB175	3	18	10	12,10 €	13,90 €	175	
22615-YMB200	3	20	10	12,68 €	14,58 €	200	
22615-YMB250	4	26	10	13,88 €	15,95 €	250	
22615-YMB300	4	30	10	15,96 €	18,34 €	300	
22615-YMB350	5	36	10	19,84 €	22,81 €	350	
22615-YMB400	5	40	10	23,08 €	26,53 €	400	
22615-YMB450	5	46	10	25,80 €	29,66 €	450	
22615-YMB500	6	50	10	28,92 €	33,25 €	500	
22615-YMB600	6	60	10	32,38 €	37,22 €	600	

TRIM CORREDERA PERFECTA Conjuntos completos con soporte a techo (20615-04) Corredera ref. 23645-113	REF	Soportes Brackets Supports	Correderas paso 6		Correderas paso 8		
	22615-YMB8100	2	18	13,14 €	14	12,14 €	100
22615-YMB8150	3	28	15,53 €	20	14,03 €	150	
22615-YMB8200	3	36	19,58 €	28	17,90 €	200	
22615-YMB8250	4	44	21,95 €	36	20,95 €	250	
22615-YMB8300	4	52	25,84 €	40	23,54 €	300	
22615-YMB8350	5	62	31,31 €	48	28,81 €	350	
22615-YMB8400	5	70	36,53 €	52	33,03 €	400	
22615-YMB8450	5	78	40,16 €	60	37,16 €	450	
22615-YMB8500	6	86	45,25 €	68	41,85 €	500	
22615-YMB8600	6	102	51,22 €	80	47,22 €	600	



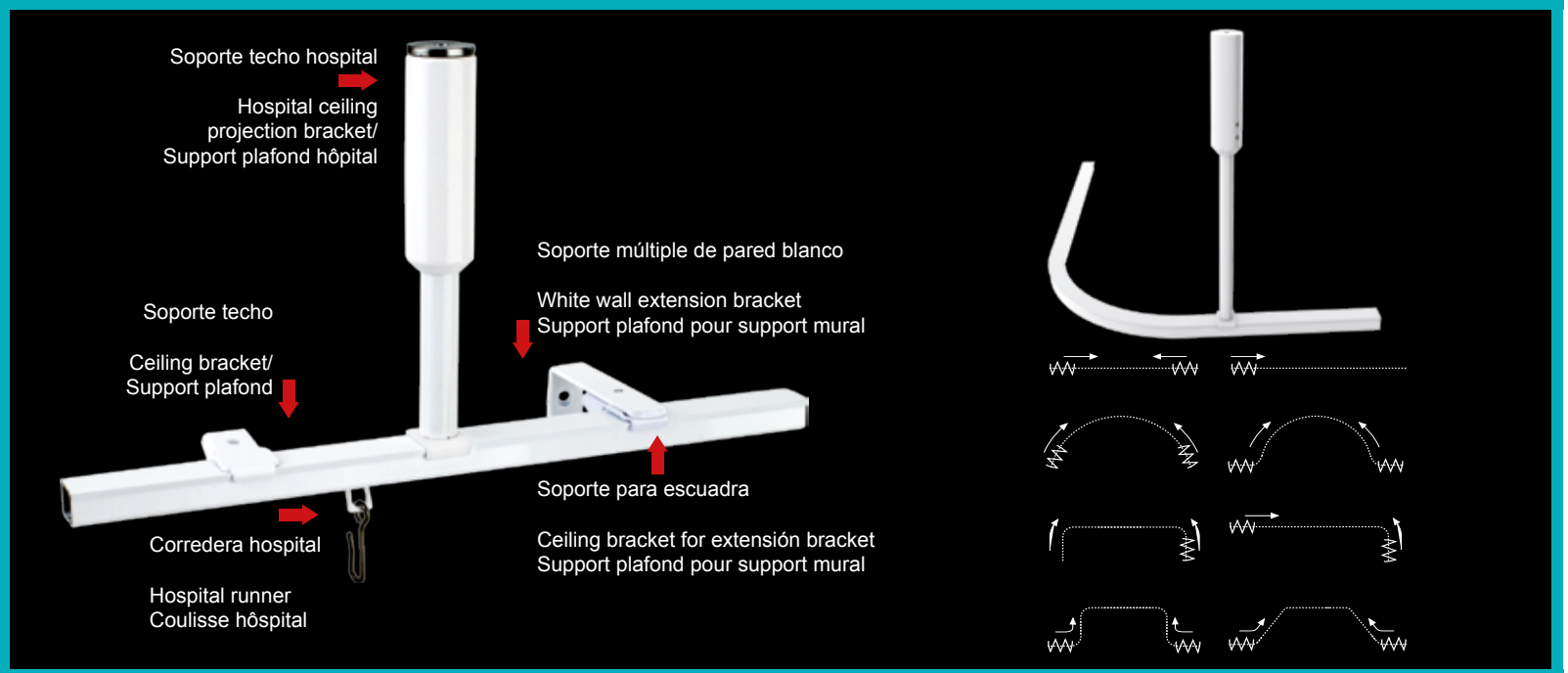

Información General / General Information / Informations Générales

- Riel de Aluminio Blanco de accionamiento manual para cortinas de peso medio (4 kg/m). Riel Versátil, resistente y adaptable. Una elección acertada para casi todo tipo de instalaciones. SE PUEDE CURVAR y ARQUEAR. El cliente debe aportar plantilla. El Curvado del Riel Trim permite diferentes Ángulos (con un radio de 10 cm.).
 € Coste por curvar en Ángulo: 70% del Precio de Tarifa del Riel (con un precio mínimo de 14,28 € PVP).
 € Coste por curvar en Arco continuo: 34,68 € PVP.

Componentes / Components / Composants



Componentes / Components / Composants

<p>Soporte Techo Hospital</p> <p>Hospital Ceiling Projection Bracket / Support Plafond Hôpital</p> 	<table border="1"> <thead> <tr> <th>REF</th> <th>∅</th> <th></th> <th></th> <th></th> <th></th> </tr> </thead> <tbody> <tr> <td>22619-408</td> <td></td> <td>1</td> <td></td> <td>23,56 €/m</td> <td>100</td> </tr> <tr> <td>22619-409</td> <td></td> <td>1</td> <td></td> <td>28,26 €/m</td> <td>150</td> </tr> </tbody> </table>	REF	∅					22619-408		1		23,56 €/m	100	22619-409		1		28,26 €/m	150
REF	∅																		
22619-408		1		23,56 €/m	100														
22619-409		1		28,26 €/m	150														
<p>Corredera Hospital</p> <p>Hospital Runner / Coulisse Hôpital</p> 	<table border="1"> <thead> <tr> <th>REF</th> <th>∅</th> <th></th> <th></th> <th></th> <th></th> </tr> </thead> <tbody> <tr> <td>D.010</td> <td></td> <td>50</td> <td>0,50 €</td> <td>0,58 €</td> <td></td> </tr> </tbody> </table>	REF	∅					D.010		50	0,50 €	0,58 €							
REF	∅																		
D.010		50	0,50 €	0,58 €															
<p>Curvadora continua con alma 7m.</p> <p>Bending Machine (Continuous curves) / Machine a Cintrer (Cintrage continu)</p> 	<table border="1"> <thead> <tr> <th>REF</th> <th>∅</th> <th></th> <th></th> <th></th> <th></th> </tr> </thead> <tbody> <tr> <td>M.123</td> <td></td> <td>1</td> <td></td> <td>1.515,16 €</td> <td></td> </tr> </tbody> </table>	REF	∅					M.123		1		1.515,16 €							
REF	∅																		
M.123		1		1.515,16 €															
<p>Curvadora Ángulo</p> <p>Bending Machine (Angle bending) / Machine pour cintrer (Cintrage e Angle)</p> 	<table border="1"> <thead> <tr> <th>REF</th> <th>∅</th> <th></th> <th></th> <th></th> <th></th> </tr> </thead> <tbody> <tr> <td>M.124</td> <td></td> <td>1</td> <td></td> <td>2.934,10 €</td> <td></td> </tr> </tbody> </table>	REF	∅					M.124		1		2.934,10 €							
REF	∅																		
M.124		1		2.934,10 €															
<p>Alma 7m. para curvadora</p> <p>Bending Strip / Profil de Cintrage</p> 	<table border="1"> <thead> <tr> <th>REF</th> <th>∅</th> <th></th> <th></th> <th></th> <th></th> </tr> </thead> <tbody> <tr> <td>M.121</td> <td></td> <td>1</td> <td></td> <td>132,60 €</td> <td></td> </tr> </tbody> </table>	REF	∅					M.121		1		132,60 €							
REF	∅																		
M.121		1		132,60 €															

Componentes / Components / Composants

Riel
Track /
Rail

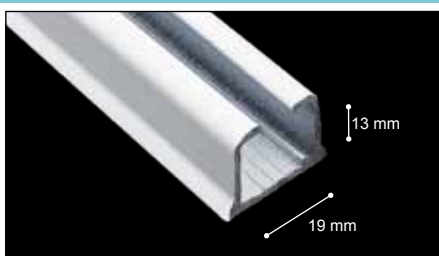

REF	Ø	U	€	€	cm
22615-12042BL		60m	3,60 €/m	4,14 €/m	600

*Tapa

*Encap /
*Bouchon final



REF	Ø	U	€	€	cm
22615-06		25	0,34 €	0,39 €	

* Tapa con alojamiento para corredera tope
Encap w/hosting for endstop runner / Bouchon final pour glisseur d'arrêt.

Soporte techo
Ceiling Bracket /
Support Plafond



REF	Ø	U	€	€	cm
22615-44		50	0,98 €	1,13 €	

Soporte Pared
Wall Bracket /
Support Mur



REF	Ø	U	€	€	cm
22615-02		25	4,28 €	4,92 €	

Soporte Doble
Pared
Double Wall
Bracket /
Support Mur double



REF	Ø	U	€	€	cm
22615-03		25	6,20 €	7,13 €	

Soporte Techo
Ceiling Bracket /
Support Plafond



REF	Ø	U	€	€	cm
22615-04		50	0,30 €	0,35 €	

* Soporte incluido en el kit / Bracket supplied in the kit / Support fourni dans le kit.

Soporte para
Escuadra
Ceiling Bracket
for Extension
Bracket/
Support Plafond
pour support Mural

























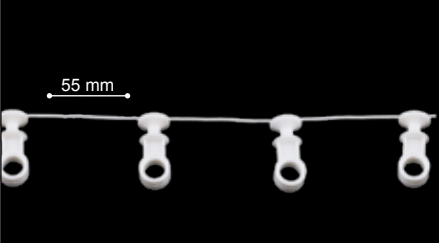











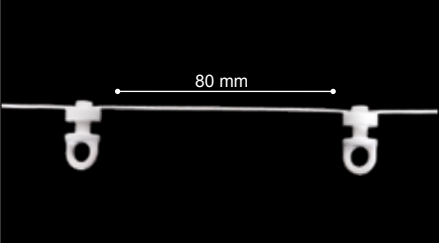











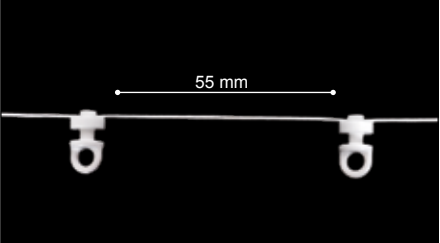





















































REF	Ø	U	€	€	cm
22615-48		50	1,02 €	1,17 €	

Corredera
Plastic Runner /
Coulisse Plastic



REF	Ø	U	€	€	cm
23643-07		500	0,08€/ud	0,092 €/ud	

Componentes / Components / Composants

<p>Rollo Cinta Acordeón con Automáticos</p> <p>Ruffle-tape roll with snap-buttons / Rouleau ruban accordéon avec système automat</p>		<table border="1"> <thead> <tr> <th>REF</th> <th>∅</th> <th></th> <th></th> <th></th> <th></th> </tr> </thead> <tbody> <tr> <td>23611-BCCO</td> <td></td> <td>1000 (correderas)</td> <td>0,20 €</td> <td>0,23 €</td> <td></td> </tr> </tbody> </table>	REF	∅					23611-BCCO		1000 (correderas)	0,20 €	0,23 €	
REF	∅													
23611-BCCO		1000 (correderas)	0,20 €	0,23 €										
<p>Rollo Corredera Acordeón</p> <p>Corded gliders roll / Rouleau glisseurs acordeón</p>	 <p>55 mm</p>	<table border="1"> <thead> <tr> <th>REF</th> <th>∅</th> <th></th> <th></th> <th></th> <th></th> </tr> </thead> <tbody> <tr> <td>23611-ACC</td> <td></td> <td>1000 (correderas)</td> <td>0,15 €</td> <td>0,18 €</td> <td></td> </tr> </tbody> </table>	REF	∅					23611-ACC		1000 (correderas)	0,15 €	0,18 €	
REF	∅													
23611-ACC		1000 (correderas)	0,15 €	0,18 €										
<p>Rollo Corredera Onda Perfecta</p> <p>Perfect wave runners roll / Rouleau de glisseur "onde parfaite"</p>	 <p>80 mm</p>	<table border="1"> <thead> <tr> <th>REF</th> <th>∅</th> <th></th> <th></th> <th></th> <th></th> </tr> </thead> <tbody> <tr> <td>23645-113</td> <td></td> <td>1000 (correderas)</td> <td>0,15 €</td> <td>0,18 €</td> <td></td> </tr> </tbody> </table>	REF	∅					23645-113		1000 (correderas)	0,15 €	0,18 €	
REF	∅													
23645-113		1000 (correderas)	0,15 €	0,18 €										
<p>Rollo Corredera Onda Perfecta</p> <p>Perfect wave runners roll / Rouleau de glisseur "onde parfaite"</p>	 <p>55 mm</p>	<table border="1"> <thead> <tr> <th>REF</th> <th>∅</th> <th></th> <th></th> <th></th> <th></th> </tr> </thead> <tbody> <tr> <td>23646-114</td> <td></td> <td>1000 (correderas)</td> <td>0,15 €</td> <td>0,18 €</td> <td></td> </tr> </tbody> </table>	REF	∅					23646-114		1000 (correderas)	0,15 €	0,18 €	
REF	∅													
23646-114		1000 (correderas)	0,15 €	0,18 €										
<p>Tornillo Tope</p> <p>End-stop / Vis avec Écrou</p>		<table border="1"> <thead> <tr> <th>REF</th> <th>∅</th> <th></th> <th></th> <th></th> <th></th> </tr> </thead> <tbody> <tr> <td>22643-08</td> <td></td> <td>1000</td> <td>0,31 €</td> <td>0,36 €</td> <td></td> </tr> </tbody> </table>	REF	∅					22643-08		1000	0,31 €	0,36 €	
REF	∅													
22643-08		1000	0,31 €	0,36 €										
<p>Codo Riel</p> <p>Elbow / Coude</p>		<table border="1"> <thead> <tr> <th>REF</th> <th>∅</th> <th></th> <th></th> <th></th> <th></th> </tr> </thead> <tbody> <tr> <td>22615-40</td> <td></td> <td>25</td> <td>1,94 €</td> <td>2,23 €</td> <td></td> </tr> </tbody> </table>	REF	∅					22615-40		25	1,94 €	2,23 €	
REF	∅													
22615-40		25	1,94 €	2,23 €										
<p>Soporte Techo</p> <p>Ceiling Bracket / Support Plafond</p>		<table border="1"> <thead> <tr> <th>REF</th> <th>∅</th> <th></th> <th></th> <th></th> <th></th> </tr> </thead> <tbody> <tr> <td>22615-01</td> <td></td> <td>50</td> <td>0,84 €</td> <td>3,57 €</td> <td></td> </tr> </tbody> </table>	REF	∅					22615-01		50	0,84 €	3,57 €	
REF	∅													
22615-01		50	0,84 €	3,57 €										
<p>Corredera Maestra</p> <p>Plastic Master Runner / Coulisse Plastic Principal</p>		<table border="1"> <thead> <tr> <th>REF</th> <th>∅</th> <th></th> <th></th> <th></th> <th></th> </tr> </thead> <tbody> <tr> <td>22615-42</td> <td></td> <td>25</td> <td>3,10 €</td> <td>3,57 €</td> <td></td> </tr> </tbody> </table>	REF	∅					22615-42		25	3,10 €	3,57 €	
REF	∅													
22615-42		25	3,10 €	3,57 €										

Componentes / Components / Composants

Soporte múltiple de pared Blanco

White Wall Extension Bracket / Support Blanc Mural



REF	∅	U	€	1	cm
90609-B30		25	1,16 €	1,34 €	4
90609-B50		25	1,36 €	1,57 €	6
90609-B80		25	1,76 €	2,03 €	10
90609-B120		25	2,44 €	2,81 €	15
90609-B180		25	3,16 €	3,64 €	20

Muestra riel TRIM

Demo sample Trim track / Echantillon Rail TRIM

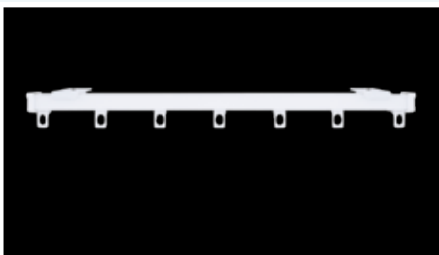

REF	∅	U	€	1	cm
M.300		1		6,42 €	

El perfecto equilibrio entre material y diseño

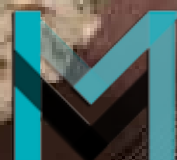

Marvent
SOLUCIONES PARA DECORAR VENTANAS

SERIE PRESTIGE

Presentamos la colección "Prestige" en dos series:

- Romantic en colores clásicos
- Neons en colores vivos y alegres

*Colección bajo pedido

GENIL Riel Manual / Hand-Drawn Track GENIL / Rail Manuelle GENIL



Blanco
White
Blanc

	REF	Soportes Brackets Supports	Correderas Gliders Glisseur				
GENIL Conjuntos completos con soporte a techo (23613-S) / Complete sets with ceiling Bracket (23613-S) / Kits complets avec support Plafond (23613-S)	22613-YMB100	2	10	10	6,96 €	8,01 €	100
	22613-YMB125	2	12	10	8,08 €	9,30 €	125
	22613-YMB150	3	16	10	9,32 €	10,72 €	150
	22613-YMB175	3	18	10	10,54 €	12,13 €	175
	22613-YMB200	3	20	10	12,74 €	14,66 €	200
	22613-YMB250	4	26	10	15,34 €	17,65 €	250
	22613-YMB300	4	30	10	17,54 €	20,18 €	300
	22613-YMB350	5	36	10	19,92 €	22,91 €	350
	22613-YMB400	5	40	10	22,28 €	25,63 €	400
	22613-YMB450	5	46	10	24,56 €	28,25 €	450
	22613-YMB500	6	50	10	27,12 €	31,19 €	500
	22613-YMB600	6	60	10	32,32 €	37,17 €	600



Gris
Grey
Grey

	REF	Soportes Brackets Supports	Correderas Gliders Glisseur				
ARGENT GRIS Riel Manual / Hand-Drawn Track GREY ARGENT / Rail Manuelle GREY ARGENT Conjuntos completos con soporte a techo (22608-25GR) / Complete sets with ceiling Bracket (22608-25GR) / Kits complets avec support Plafond (22608-25GR)	22608-YMP100	2	10	10	7,86 €	9,43 €	100
	22608-YMP150	3	16	10	11,36 €	13,63 €	150
	22608-YMP200	3	20	10	14,38 €	17,26 €	200
	22608-YMP250	4	26	10	17,90 €	21,48 €	250
	22608-YMP300	4	30	10	20,90 €	25,08 €	300
	22608-YMP350	5	36	10	24,40 €	29,28 €	350
	22608-YMP400	5	40	10	27,42 €	32,90 €	400
	22608-YMP450	5	46	10	30,64 €	36,77 €	450
	22608-YMP500	6	50	10	33,92 €	40,70 €	500
	22608-YMP550	6	56	10	40,14 €	48,17 €	600

Información General / General Information / Informations Générales

- El Riel Argent se puede Curvar en diferentes Ángulos (con un radio de 10 cm. El cliente debe aportar plantilla). Coste por curvar en Ángulo: 70% del Precio de Tarifa del Riel (con un precio mínimo de 14,28 € PVP).
- It can be curved to customer specifications at different angles and shapes. The client should provide the template Cost for curving at angle: 70% of the kit tariff price (minimum fee of € 14,28 SRP).
- On peut produire différentes formes et cintrage dans divers angles (rayon minimal 10cm). Le client doit fournir le modèle. Coût par cintrer en angle: 70% du prix tarif du kit (à un prix minimum de 14,28 € prix PDC).

Componentes / Components / Composants

Riel de aluminio
(14x17mm.)

Aluminium track
(14x17mm) /
Rail aluminium
(14x17mm)

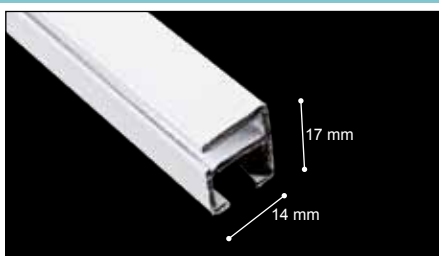

REF	∅	U	€	€	cm
22613-120		120 m	3,20 €/m	3,68 €/m	600
22608-12016AP		60 m	4,32 €/m	5,18 €/m	600

Soporte
de plástico

Plastic bracket /
Support plastique



REF	∅	U	€	€	cm
22613-S		200	0,24 €	0,28 €	
22608-25GR		50	0,38 €	0,44 €	

* Soporte incluido en el kit /
Bracket supplied in the kit / Support fourni dans le kit.

Tapa corredera

End cap /
Bouchon final



REF	∅	U	€	€	cm
22613-T		200	0,24 €	0,28 €	
22608-22GR		50	0,37 €	0,43 €	

Corredera con
ruedas

Wheeled glider /
Glisseur a roue



REF	∅	U	€	€	cm
22613-C		500	0,08 €	0,09 €	

Conjunto corredera
maestra

Overlap master
carrier /
Porteur principal
chevauchant



REF	∅	U	€	€	cm
22613-1001		50	2,42 €	2,90€	

Tirador

Wand /
Lance rideau

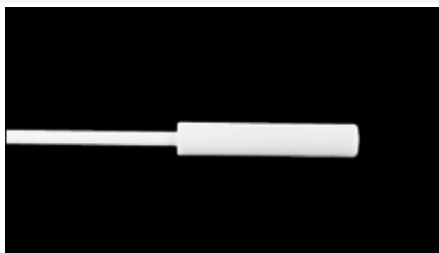

REF	∅	U	€	€	cm
90609-TI		25	2,00 €	2,30 €	100
90609-TI150		25	3,14 €	3,61 €	150

Máquina Curvar
Argent

Argent Bending
Machine /
Machine pour
cintrear Argent



REF	∅	U	€	€	cm
90609-M122		1		640,00 €	

* Alma para Curvar (Ref. M.120 precio 24,48 € PVP)
Bending strip (Ref. M.120 price 24.48 SRP) / Profil de cintrage (Ref .M.120 prix 24.48 PVP)

Muestra riel
ARGENT

Demo sample
ARGENT track /
Echantillon
Rail ARGENT

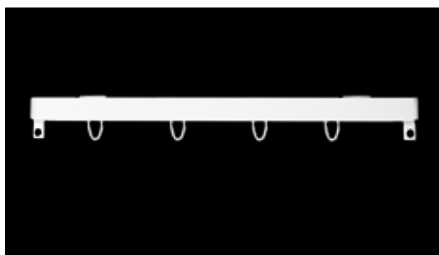

REF	∅	U	€	€	cm
M-301		1		6,50 €	

RIEL 7300 Riel Manual / Hand-Drawn Track RIEL 7300 / Rail Manuelle RIEL 7300



Blanco
White
Blanc

	REF	Soportes Brackets Supports	Correderas Gliders Glisseur				
RIEL 7300 Conjuntos completos con soporte a techo (22613-M3700) / Complete sets with ceiling Bracket (22613-M3700) / Kits complets avec support Plafond (22613-M3700)	22613-3700100	2	10	10	8,14 €	9,37 €	100
	22613-3700150	3	16	10	11,70 €	13,46 €	150
	22613-3700200	3	20	10	14,26 €	16,40 €	200
	22613-3700250	4	26	10	17,80 €	20,47 €	250
	22613-3700300	4	30	10	20,38 €	23,44 €	300
	22613-3700350	5	36	10	23,92 €	27,51 €	350
	22613-3700400	5	40	10	26,50 €	30,48 €	400
	22613-3700450	5	46	10	29,28 €	33,68 €	450
	22613-3700500	6	50	10	32,62 €	37,52 €	500
	22613-3700600	6	56	10	37,96 €	43,66 €	550

Componentes / Components / Composants

Riel de aluminio (14x13mm.)

Aluminium track (14x12mm) / Rail aluminium (14x12mm)

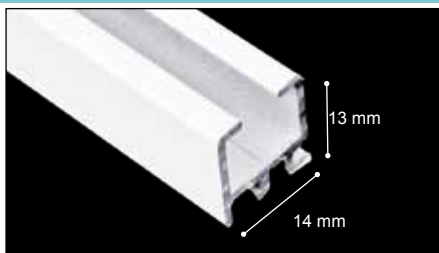

REF					
22613-B3700		120 m	3,00 €/m	3,45 €/m	600

Soporte de techo zincado

Metal bracket / Support metal



REF					
22613-M3700		100	1,00 €	1,15 €	

* Soporte incluido en el kit / Bracket supplied in the kit / Support fourni dans le kit.

Soporte de techo plástico

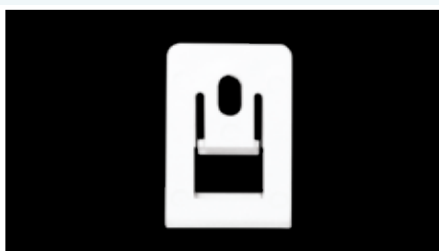

REF					
22613-S3700		200	0,12 €	0,23 €	

Componentes / Components / Composants

Tapa corredera

End cap /
Bouchon final



REF	∅	U	€	1	cm
22613-T3700		200	0,20 €	0,23 €	

Corredera
con ruedas

Wheeled glider/
Glisseur a roue



REF	∅	U	€	1	cm
22613-C		500	0,08 €	0,09 €	

Corredera

Glider /
Glisseur



REF	∅	U	€	1	cm
23643-07		500	0,08 €	0,09 €	

Conjunto corredera
maestra

Overlap master
carrier /
Porteur principal
chevauchant



REF	∅	U	€	1	cm
22613-1001		50	2,42 €	2,90 €	

Tirador

Wand /
Lance rideau



REF	∅	U	€	1	cm
90609-TI		25	2,00 €	2,30 €	100
90609-TI150		25	3,14 €	3,61 €	150

Muestra riel
BALEAR

Demo sample
BALEAR track /
Echantillon
Rail BALEAR

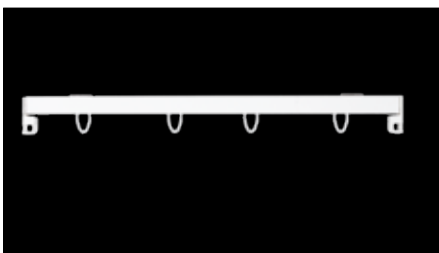

REF	∅	U	€	1	cm
M-302		1		6,42 €	

MARVENT
SOLUCIONES PARA DECORAR VENTANAS

CORTINAS ENROLLABLES

Ponemos a disposición de nuestros clientes una amplia gama de tejidos técnicos para cortinas enrollables.
Solicite catálogos y tarifas.

BASIC Riel Manual / Hand-Drawn Track BASIC / Rail Manuelle BASIC



Blanco
White
Blanc

	REF	Soportes Brackets Supports	Correderas Gliders Glisseur				
BASIC	E.1003	-	10	10	7,02 €	8,07 €	100
Conjuntos completos. /	E.1503	-	16	10	9,92 €	11,41 €	150
Complete sets. /	E.2003	-	20	10	12,72 €	14,63 €	200
Kits completS.	E.2503	-	26	10	15,58 €	17,92 €	250
	E.3003	-	30	10	18,38 €	21,14 €	300
Incremento para Sistema Onda Perfecta	E.3503	-	36	10	21,26 €	24,45 €	350
Price increase perfect wave system	E.4003	-	40	10	24,04 €	27,65 €	400
Hausse prix système onde parfaite	E.4503	-	46	10	26,92 €	30,96 €	450
	E.5003	-	50	10	29,70 €	34,16 €	500
	E.6003	-	60	10	35,38 €	40,69 €	600

Componentes / Components / Composants

Riel de aluminio
(25x10mm.)

Aluminium track
(25x10mm) /
Rail aluminium
(25x10mm)

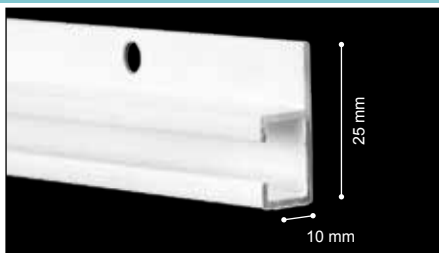

REF					
C.12015BL		60 m	4,20 €/m	4,83 €/m	600

Tapa

Cap /
Bouchon

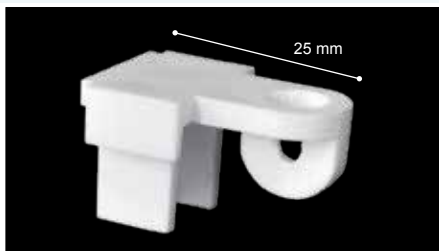

REF					
D.19		100	0,50 €	0,58 €	

Corredera

Glider /
Glisseur



REF					
23643-07		500	0,08 €	0,09 €	

Muestra riel
BASIC

Demo sample
BASIC track /
Echantillon
Rail BASIC

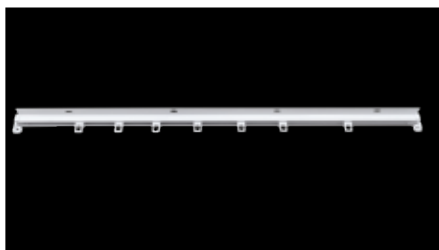

REF					
M.309		1		6,42 €	

FIJO Riel Manual / Hand-Drawn Track FIJO / Rail Manuelle FIJO



Riel FIJO hierro serie 1000 Manual o Cordón /
Hand-drawn or Cord-drawn track /
Rail avec tirage Manuel ou avec Corde



Componentes riel FIJO / FIJO rail Components / Composants FIJO rail

Caña C
(4'8 m)

C-track /
Canne C

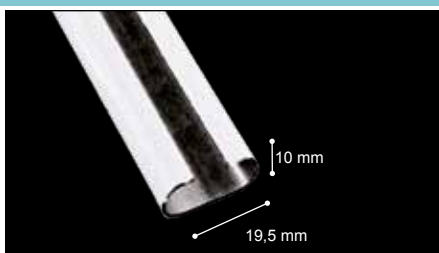

REF	∅	U	€	€	cm
I.1000		48	1,82 €/m	2,09 €/m	480

Caña C perforada
(4 m)

Perforated C-track /
Canne C perforée



REF	∅	U	€	€	cm
I.1000P		100	1,92 €/m	2,21 €/m	400

* Bajo Pedido / Upon Request / Sur Demande

Juego de
cantoneras
(par)

End pulleys (pair) /
Jeux d'angles (paire)



REF	∅	U	€	€	cm
I.1221		20 pares	2,92 €	3,36 €	

Soporte lateral
60mm. (par)

Side bracket
60mm. (pair) /
Support latéral
60mm. (paire)



REF	∅	U	€	€	cm
I.1100		12 pares	1,86 €	2,14 €	

Soporte lateral
80mm. (par)

Side bracket
80mm. (pair) /
Support latéral
80mm. (paire)



REF	∅	U	€	€	cm
I.1101		12 pares	1,86 €	2,14 €	

Soporte lateral
110mm. (par)

Side bracket
110mm. (pair) /
Support latéral
110mm. (paire)



REF	∅	U	€	€	cm
I.1102		12 pares	2,22 €	2,55 €	

Componentes / Components / Composants

Soporte central
60 mm. (par)

Central bracket
60 mm. (pair) /
Support central
60mm. (paire)



REF	∅				
I.1200		24	1,24 €	1,43 €	

Soporte central
80 mm. (par)

Central bracket
80 mm. (pair) /
Support central
80mm. (paire)



REF	∅				
I.1201		24	1,26 €	1,45 €	

Soporte central
110 mm. (par)

Central bracket
110 mm. (pair) /
Support central
110mm. (paire)



REF	∅				
I.1202		24	1,38 €	1,59 €	

Encaje para soporte
lateral (par)

Central bracket
60 mm. (pair) /
Assemblage pour
support latéral
(paire)



REF	∅				
I.1105		25 pares	1,22 €	1,40 €	

Estribo soporte

Stirrup /
Support étrier



REF	∅				
I.1205		100	0,54 €	0,62 €	

Extensión para
soporte (90mm.)

Bracket extension
(90mm) /
Prolongateur pour
support (90mm.)

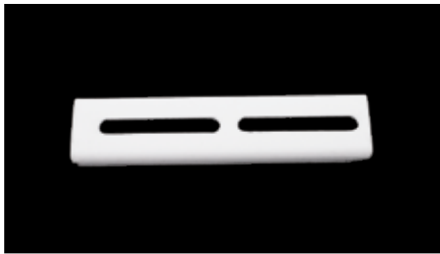

REF	∅				
I.1106		50	1,08 €	1,24 €	

Extensión para
soporte (130mm.)

Bracket extension
(130mm) /
Prolongateur pour
support (130mm.)



REF	∅				
I.1107		50	1,36 €	1,56 €	

Empalme
para caña

Splice /
Raccord pour
canne



REF	∅				
I.1007		20	0,48 €	0,55 €	

Componentes / Components / Composants

Cantenera interior

Inner polley /
Angle intérieur



REF	∅	U	€	€	cm
I.1240		20	0,92 €	1,06 €	

Tornillo con
tuerca M-4

Screw M-4 /
Vis avec M-4



REF	∅	U	€	€	cm
I.1210		200	0,12 €	0,14 €	

Terminal encaje
en soporte

End fitting
bracket /
Support
terminal emboité



REF	∅	U	€	€	cm
I.1402		20	0,46 €	0,53 €	

Corredera
intermedia

Intermediate
runner /
Coulisse
intermédiaire



REF	∅	U	€	€	cm
I.1248		20	1,10 €	1,27 €	

Corredera
intermedia encaje
en soporte

Int. runner-bracket
fiting /
Coulisse
intermédiaire
d'assemblage
encastrée



REF	∅	U	€	€	cm
I.1242		20	0,62 €	0,71 €	

Terminal simple

Plain end cap /
Embout



REF	∅	U	€	€	cm
I.1401		100	0,44 €	0,51 €	

Tope terminal con
corredera

Endcap stop
with runner /
Butoir terminal
avec coulisse



REF	∅	U	€	€	cm
I.1400		100	0,60 €	0,69 €	

Corredera plástico

Plastic runner /
Coulisse plástico



REF	∅	U	€	€	cm
I.1307		1000	0,056 €	0,064 €	

Componentes / Components / Composants

Corredera maestra curva

Curved master carrier /
Coulisse maîtresse



REF	∅				
I.1300		20	2,76 €	3,17 €	

Juego correderas maestra simple

Curved master carrier set /
Jeux de coulisses



REF	∅				
I.1301		25	2,02 €	2,32 €	

Corredera intermedia ancha

Wide intermediate runner /
Coulisse intermédiaire large



REF	∅				
I.1302		30	0,76 €	0,87 €	

Corredera maestra un sentido

Master carrier-one way /
Coulisse maîtresse un sens



REF	∅				
I.1303		20	1,24 €	1,43 €	

Tope caña perforada

Track stop-perforated /
Embout canne perforée



REF	∅				
I.1580		100	0,19 €	0,22 €	

Corredera horizontal

Horizontal runner /
Coulisse horizontale

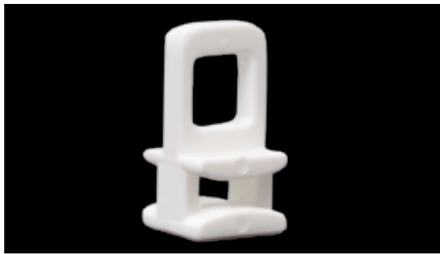

REF	∅				
I.1901		1000	0,12 €	0,14 €	

Rollo 500 metros cordón de 2,7mm.

Cord roll 2,7mm./
Rouleau de corde 2,7mm.

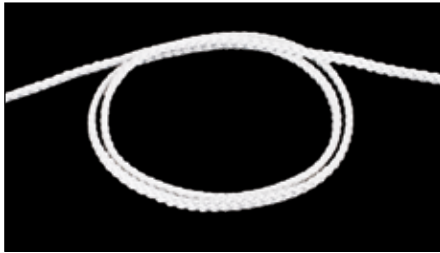

REF	∅				
D.12P		1	110,52 €		500

Rollo 250 metros cordón de 3mm.

Cord roll 3mm. /
Rouleau de corde 3mm.



REF	∅				
22619-12P		250	0,13 €/m		250

Componentes / Components / Composants

Contrapeso petaca

Cordweight /
contrepoids



REF	∅	U	€	€	cm
90977-1700BL		25	2,02 €	2,32 €	

Contrapeso mini
(43 g aprox.)

Mini-cordweight /
Mini-contrepoids



REF	∅	U	€	€	cm
90977-1110BL		25	1,36 €	1,56 €	
90977-1110PL		25	2,06 €	2,37 €	

Tensor sencillo

Cord guide /
Guide de corde



REF	∅	U	€	€	cm
22605-TS		50	0,42 €	0,48 €	

Tensor perilla

Cord weighted
tassel /
Gland pour corde



REF	∅	U	€	€	cm
22605-TP		50	1,16 €	1,39 €	



MOSQUITERAS

MALEABLE Riel Manual / Hand-Drawn Track MALEABLE / Rail Manuelle MALEABLE



Blanco
White
Blanc

NERVIÓN . Doble T

Conjuntos completos. /

Complete sets. /

Kits complets.

REF	Soportes Brackets Supports	Correderas Gliders Glisseur	U	€	€	cm
22616-YMB150	3	16	1		13,48 €	150
22616-YMB200	4	20	1		16,11 €	200
22616-YMB250	5	26	1		19,78 €	250
22616-YMB300	6	30	1		22,47 €	300
22616-YMB350	7	36	1		26,13 €	350
22616-YMB400	8	40	1		28,82 €	400
22616-YMB450	9	46	1		32,46 €	450
22616-YMB500	10	50	1		35,14€	500

Información General / General Information / Informations Générales

 Fácil de doblar a la forma deseada con las manos. Ideal para ventanas curvadas o instalaciones con rincones y/o esquinas.

 Easy to bend to the desired shape. Ideal for bay windows or for special installations where corner tracks are required.

 Facile à plier. Idéal pour des fenêtres arrondies ou des installations spéciales en coin.

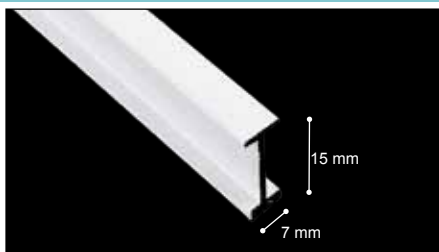

Componentes / Components / Composants

Riel Aluminio
(7x15mm)Aluminium track
(7x15mm) /
Rail aluminium
(7x15mm)

REF	∅	U	€	€	cm
22616-12020BL		60 m	2,66 €/m	3,19 €/m	600

Soporte de hierro

Steel bracket /
Support acier

REF	∅	U	€	€	cm
22616-280		50	0,50 €	0,58 €	

* Soporte incluido en el kit / Bracket supplied in the kit / Support fourni dans le kit.

Componentes / Components / Composants

Tapa corredera

End cap /
bouchon final



REF	∅	U	€	€	cm
22616-110		50	0,72 €	0,83 €	

Corredera

Glider /
Glisseur



REF	∅	U	€	€	cm
22616-420		500	0,14 €	0,16 €	

Tirador

Wand /
Lance rideau



REF	∅	U	€	€	cm
90609-TI		25	2,00 €	2,30 €	100
90609-TI150		25	3,14 €	3,61 €	150

Muestra riel
MALEABLE

Demo sample
MALEABLE track /
Echantillon
Rail MALEABLE



REF	∅	U	€	€	cm
M-304		1		6,50 €	

Marvent System somos tu empresa profesional de confianza dedicada a ayudarte a decorar tus ventanas. Nuestra experiencia en el sector de la decoración con sistemas técnicos y de alta calidad está contrastada y avalada. Contáctenos sin compromiso.

Marvent
MARVENT SYSTEM S.L.

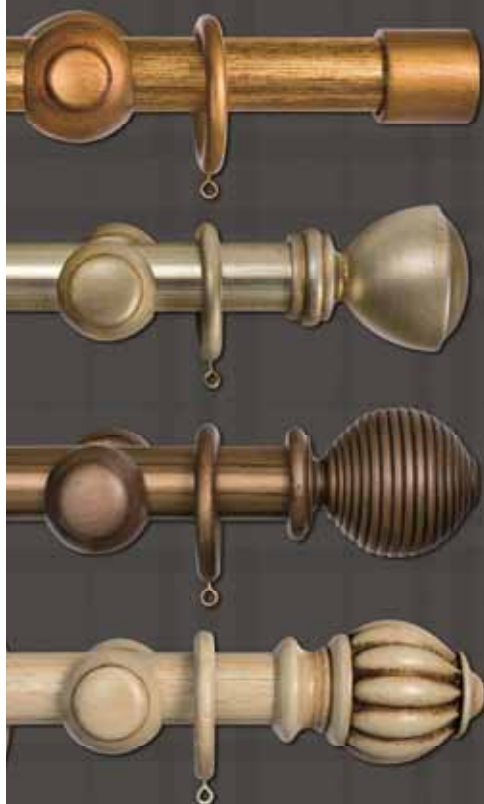

Marvent
MARVENT SYSTEM S.L.

barras de cortina
paneles japoneses
estores
rieles
motorizados
galerías
accesorios
ollaos



nueva
colección



BELMONTE
tu barra de cortina vintage en madera

Calle Valladolid, Nave 39-3 · 18151 Ogijares · Granada · Spain
Tel: +34 958 50 38 20 · administracion@marvent.es

RIEL FLEXIBLE CARLO

CARLO Riel Flexible / Flexible Track CARLO / Rail Flexible CARLO

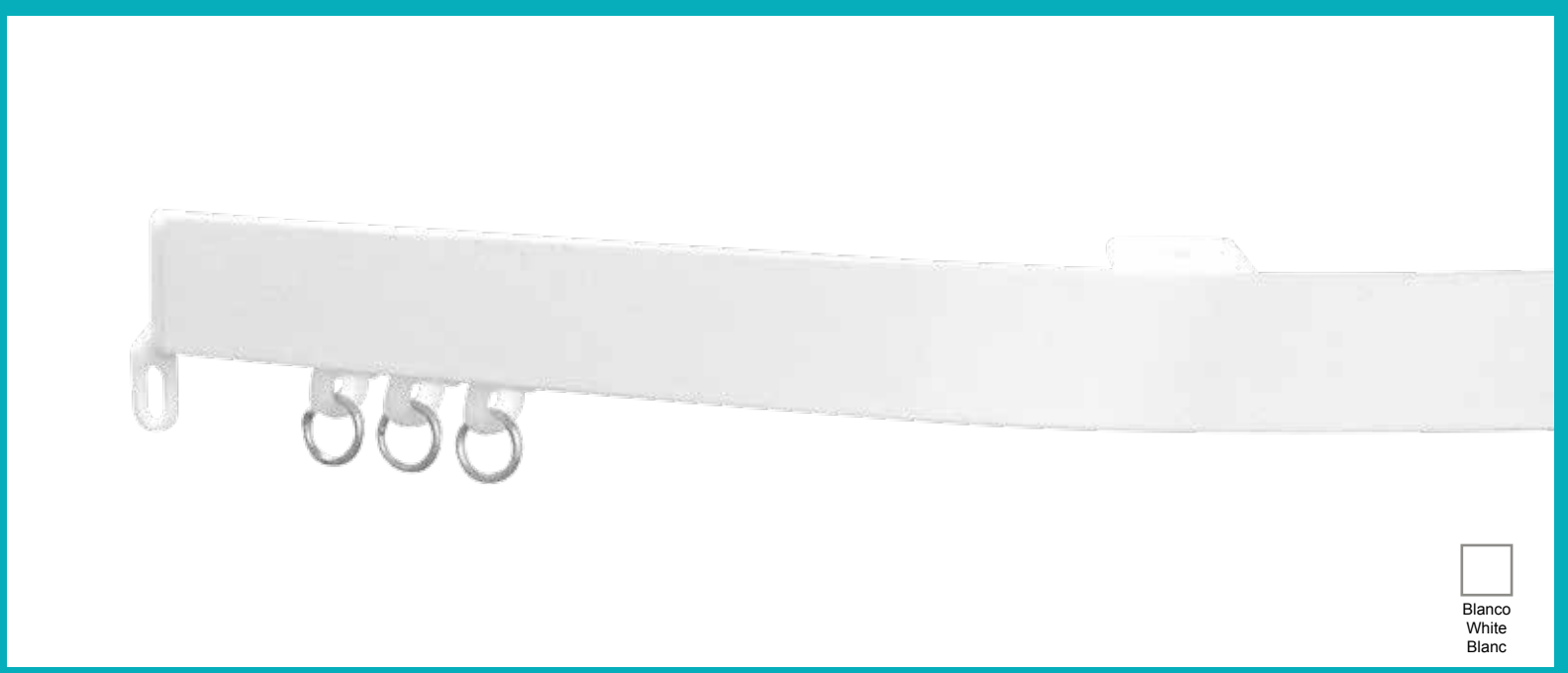

Blanco
White
Blanc

RIEL FLEXIBLE CARLO	REF	Soportes Brackets Supports	Correderas Gliders Glisseur	U	€	€	cm
	22618-MBC150	3	16	10		11,70 €	150
22618-MBC200	4	20	10		15,20 €	200	
22618-MBC250	5	26	10		18,86 €	250	
22618-MBC300	6	30	10		22,30 €	300	
22618-MBC350	7	36	10		26,60 €	350	
22618-MBC400	8	40	10		29,80 €	400	
22618-MBC500	10	50	10		37,70 €	500	

* Es un riel muy fácil de doblar. Permite hacer la forma deseada en ventanas curvadas.



DINO Riel Flexible Velcrado / Flexible Track DINO with bonded velcro / Rail Flexible avec velcro DINO

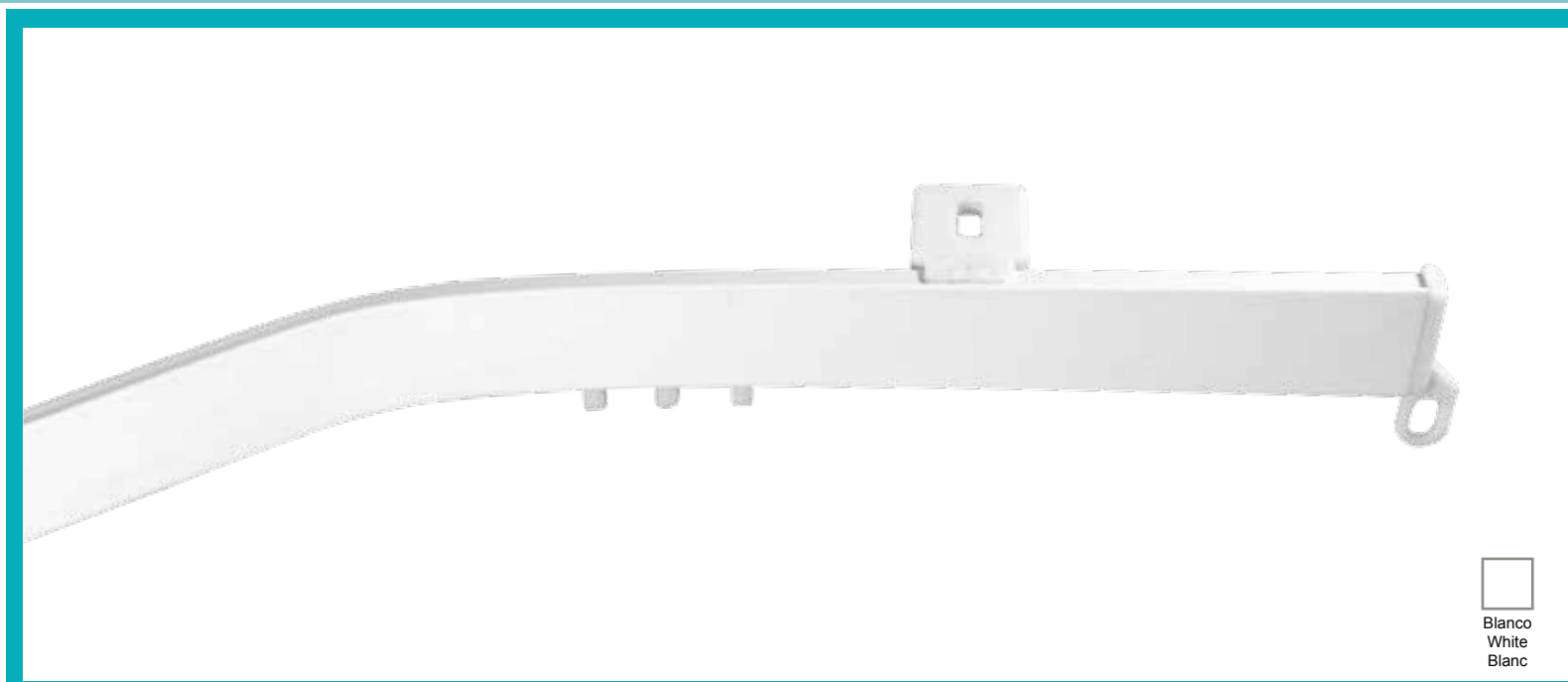

	REF	Soportes Brackets Supports	Correderas Gliders Glisseur				
RIEL FLEXIBLE VELCRADO DINO	22618-MBD150	3		10		10,60 €	150
	22618-MBD200	4		10		13,30 €	200
	22618-MBD250	5		10		16,42 €	250
	22618-MBD300	6		10		19,32 €	300
	22618-MBD350	7		10		22,46 €	350
	22618-MBD400	8		10		25,36 €	400
	22618-MBD500	10		10		33,50 €	500

* Es un riel muy fácil de doblar. Permite hacer la forma deseada en ventanas curvadas. Ideal para bandones.



FUNDAS DE COJÍN

Ponemos a su disposición una amplia gama de fundas de cojín para darle un toque cálido y confortable a su hogar.

Riel MÚLTIPLE Manual / Hand-drawn multiple CHANNELS track / Rail aluminium avec tirage Manuel



Blanco
White
Blanc

	REF	Soportes Brackets Supports	Correderas Gliders Glisseur	U	€	€	cm
Riel DOBLE 2 carriles de accionamiento Manual / Hand-drawn 2 Channels aluminium track / Rail aluminium de 2 VOIES avec tirage Manuel Conjuntos completos Complete sets/ Kits complets	22614-YM150	-	32	1		22,00 €	150
	22614-YM200	-	40	1		27,27 €	200
	22614-YM250	-	52	1		33,02 €	250
	22614-YM300	-	60	1		48,58 €	300
Para medidas mayores, consultar precios							



Blanco
White
Blanc

	REF	Soportes Brackets Supports	Correderas Gliders Glisseur	U	€	€	cm
Riel TRIPLE 3 carriles de accionamiento Manual / Hand-drawn 3 Channels aluminium track / Rail aluminium de 3 VOIES avec tirage Manuel Conjuntos completos Complete sets/ Kits complets	22614-YM3150	-	48	1		34,97 €	150
	22614-YM3200	-	60	1		48,96 €	200
	22614-YM3250	-	78	1		56,92 €	250
	22614-YM3300	-	90	1		64,16 €	300
Para medidas mayores, consultar precios							

Componentes / Components / Composants

Riel de aluminio
2 Vías
(73x13mm.)

Aluminium track
(73x13mm.) /
Rail aluminium
(73x13mm.)

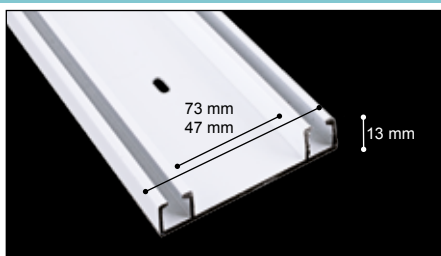

REF	∅	U	€	€	cm
22614-B		60 m	8,00 €/m	9,2 €/m	600

Riel de aluminio
3 Vías
(133x13mm.)

Aluminium track
(133x13mm.) /
Rail aluminium
(133x13mm.)

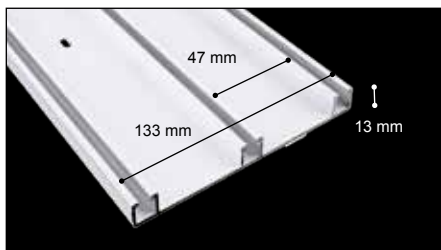

REF	∅	U	€	€	cm
22614-T3330		60 m	13,5 €/m	15,53 €/m	600

Corredera con
ruedas

Wheeled glider/
Glisseur a roue



REF	∅	U	€	€	cm
22613-C		500	0,08 €	0,09 €	

Tapa Riel

End cap /
Bouchon final



REF	∅	U	€	€	cm
22613-T		200	0,24 €	0,28 €	

Conjunto corredera
maestra

Overlap master
carrier /
Porteur principal



REF	∅	U	€	€	cm
22613-1001		50	2,42 €	2,90 €	

Tirador

Wand /
Lance rideau



REF	∅	U	€	€	cm
90609-TI		25	2,00 €	2,30 €	100
90609-TI150		25	3,14 €	3,61 €	150

Muestra riel
Múltiple

Demo sample
MULTIPLE track /
Echantillon
MULTIPLE rail

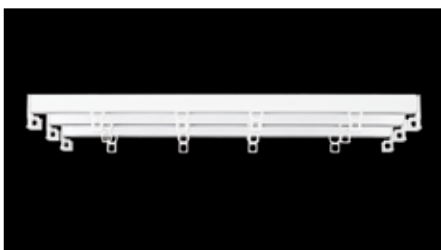

REF	∅	U	€	€	cm
M-303		1		6,50 €	

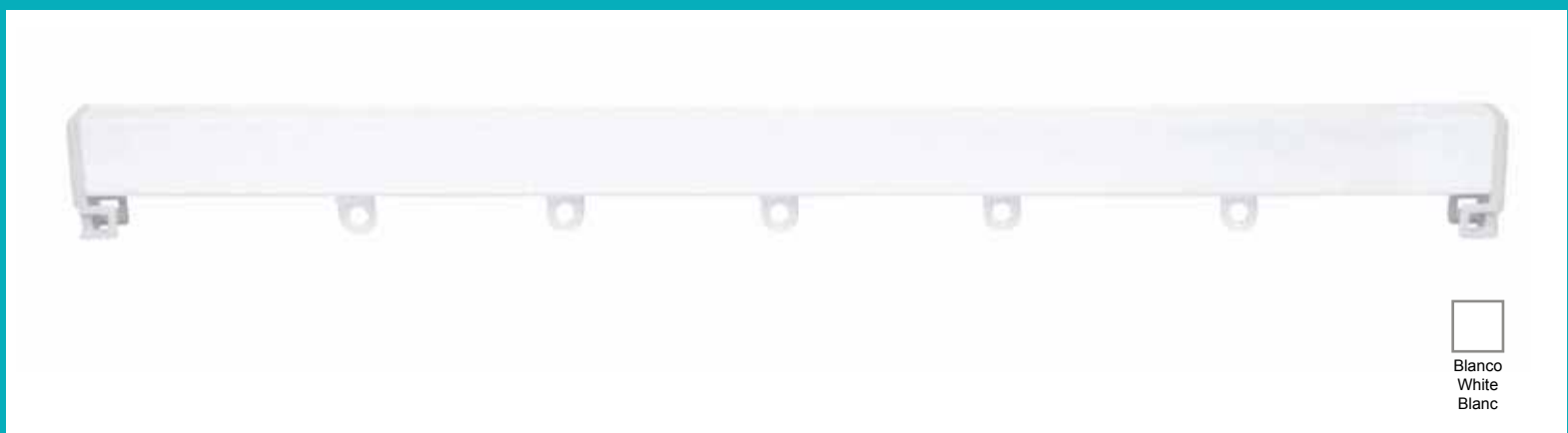

Blanco
White
Blanc



Ejemplo del riel montado con codos interior y exterior.

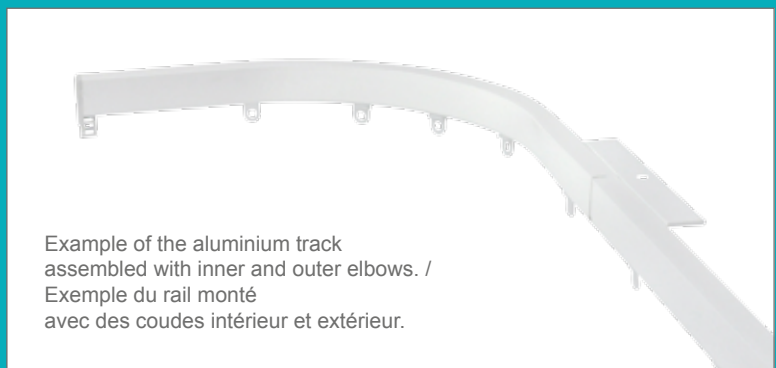

Example of the aluminium track assembled with inner and outer elbows. / Exemple du rail monté avec des coudes intérieur et extérieur.

REVA MANUAL

Conjuntos completos con soporte a techo (22619-202) / Complete sets with ceiling Bracket (22619-202) / Kits complets avec support Plafond (22619-202)

Disponibile con opción Cordón / Available with Cord System / Disponible avec option Corde

Incremento para Sistema Onda Perfecta
Price increase perfect wave system
Hausse prix système onde parfaite

D.113: 3,20 €/m
D.114: 3,20 €/m

REF	Soportes Brackets Supports	Correderas Gliders Glisseur	U	€	€	cm
22619-MB100M	2	10	6	9,40 €	10,81 €	100
22619-MB150M	3	16	6	13,76 €	15,82 €	150
22619-MB200M	3	20	6	17,30 €	19,90 €	200
22619-MB250M	4	26	6	21,68 €	24,93 €	250
22619-MB300M	4	30	6	25,20 €	28,98 €	300
22619-MB350M	5	36	6	29,56 €	33,99 €	350
22619-MB400M	5	40	6	33,10 €	38,07 €	400
22619-MB450M	5	46	6	37,46 €	43,08 €	450
22619-MB500M	6	50	6	41,00 €	47,15 €	500
22619-MB600M	6	60	6	49,36 €	56,76 €	600

Componentes / Components / Composants

Perfil de aluminio blanco

Aluminium track / Profil blanc alum.

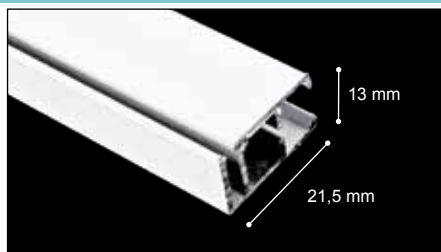

REF	Ø	U	€	€	cm
22619-12141BL		60 m	5,52 €	6,35 €	600

Soporte techo







Ceiling bracket / Support plafond

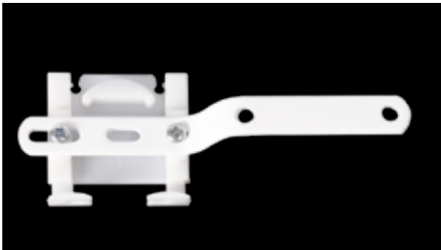

REF	Ø	U	€	€	cm
22619-202		100	0,42 €	0,49 €	

* Soporte incluido en el kit / Bracket supplied in the kit / Support fourni dans le kit.

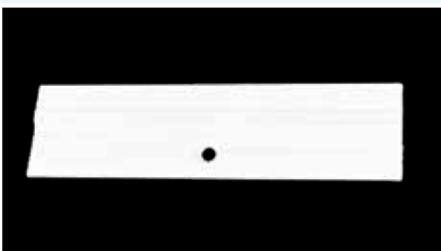
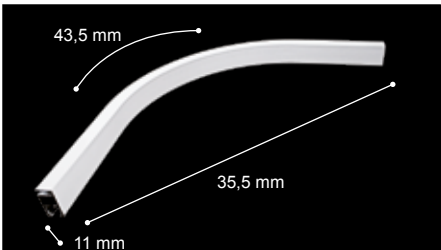
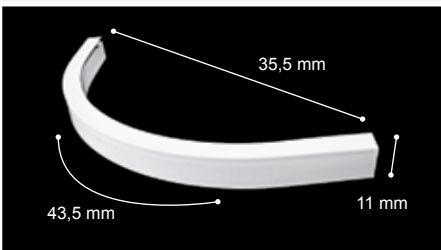
Componentes / Components / Composants

<p>Tapa End cap / Bouchon final</p>		<table border="1"> <thead> <tr> <th>REF</th> <th>∅</th> <th>U</th> <th>€</th> <th>€¹</th> <th>cm</th> </tr> </thead> <tbody> <tr> <td>22619-200</td> <td></td> <td>100</td> <td>0,44 €</td> <td>0,51 €</td> <td></td> </tr> </tbody> </table>	REF	∅	U	€	€ ¹	cm	22619-200		100	0,44 €	0,51 €							
REF	∅	U	€	€ ¹	cm															
22619-200		100	0,44 €	0,51 €																
<p>Conjunto corredera maestra Master carrier set / Kit porteur principal</p>		<table border="1"> <thead> <tr> <th>REF</th> <th>∅</th> <th>U</th> <th>€</th> <th>€¹</th> <th>cm</th> </tr> </thead> <tbody> <tr> <td>22619-206</td> <td></td> <td>25</td> <td>2,34 €</td> <td>2,69 €</td> <td></td> </tr> </tbody> </table>	REF	∅	U	€	€ ¹	cm	22619-206		25	2,34 €	2,69 €							
REF	∅	U	€	€ ¹	cm															
22619-206		25	2,34 €	2,69 €																
<p>Corredera Maestra parte curva Master carried curved part / Porteur principal partie courbée</p>		<table border="1"> <thead> <tr> <th>REF</th> <th>∅</th> <th>U</th> <th>€</th> <th>€¹</th> <th>cm</th> </tr> </thead> <tbody> <tr> <td>22619-208</td> <td></td> <td>25</td> <td>1,32 €</td> <td>1,52 €</td> <td></td> </tr> </tbody> </table>	REF	∅	U	€	€ ¹	cm	22619-208		25	1,32 €	1,52 €							
REF	∅	U	€	€ ¹	cm															
22619-208		25	1,32 €	1,52 €																
<p>Correderas Glider / Glisseur</p>		<table border="1"> <thead> <tr> <th>REF</th> <th>∅</th> <th>U</th> <th>€</th> <th>€¹</th> <th>cm</th> </tr> </thead> <tbody> <tr> <td>22619-201</td> <td></td> <td>1000</td> <td>0,15 €</td> <td>0,17</td> <td></td> </tr> </tbody> </table>	REF	∅	U	€	€ ¹	cm	22619-201		1000	0,15 €	0,17							
REF	∅	U	€	€ ¹	cm															
22619-201		1000	0,15 €	0,17																
<p>Empalme Splice / Raccordeur</p>		<table border="1"> <thead> <tr> <th>REF</th> <th>∅</th> <th>U</th> <th>€</th> <th>€¹</th> <th>cm</th> </tr> </thead> <tbody> <tr> <td>22619-203</td> <td></td> <td>25</td> <td>1,64 €</td> <td>1,89 €</td> <td></td> </tr> </tbody> </table>	REF	∅	U	€	€ ¹	cm	22619-203		25	1,64 €	1,89 €							
REF	∅	U	€	€ ¹	cm															
22619-203		25	1,64 €	1,89 €																
<p>Codo rincón 90° 90° Inner elbow / Coude interieur 90°</p>		<table border="1"> <thead> <tr> <th>REF</th> <th>∅</th> <th>U</th> <th>€</th> <th>€¹</th> <th>cm</th> </tr> </thead> <tbody> <tr> <td>22619-205</td> <td></td> <td>10</td> <td>14,84 €</td> <td>17,07 €</td> <td></td> </tr> </tbody> </table>	REF	∅	U	€	€ ¹	cm	22619-205		10	14,84 €	17,07 €							
REF	∅	U	€	€ ¹	cm															
22619-205		10	14,84 €	17,07 €																
<p>Codo esquina 90° 90° Outer elbow / Coude exterior 90°</p>		<table border="1"> <thead> <tr> <th>REF</th> <th>∅</th> <th>U</th> <th>€</th> <th>€¹</th> <th>cm</th> </tr> </thead> <tbody> <tr> <td>22619-204</td> <td></td> <td>10</td> <td>14,84 €</td> <td>17,066 €</td> <td></td> </tr> </tbody> </table>	REF	∅	U	€	€ ¹	cm	22619-204		10	14,84 €	17,066 €							
REF	∅	U	€	€ ¹	cm															
22619-204		10	14,84 €	17,066 €																
<p>Tirador Wand / Lance rideau</p>		<table border="1"> <thead> <tr> <th>REF</th> <th>∅</th> <th>U</th> <th>€</th> <th>€¹</th> <th>cm</th> </tr> </thead> <tbody> <tr> <td>90609-TI</td> <td></td> <td>25</td> <td>2,00 €</td> <td>2,30 €</td> <td>100</td> </tr> <tr> <td>90609-TI150</td> <td></td> <td>25</td> <td>3,14 €</td> <td>3,61 €</td> <td>150</td> </tr> </tbody> </table>	REF	∅	U	€	€ ¹	cm	90609-TI		25	2,00 €	2,30 €	100	90609-TI150		25	3,14 €	3,61 €	150
REF	∅	U	€	€ ¹	cm															
90609-TI		25	2,00 €	2,30 €	100															
90609-TI150		25	3,14 €	3,61 €	150															

Componentes / Components / Composants

Soporte múltiple de pared extrafuerte

Wall extension bracket (extrastrong) / Support mur extrafort



REF	∅	U	€	€	cm
90609-B3001		25	3,36 €	3,86 €	7
90609-B3002		25	4,04 €	4,65 €	11
90609-B3003		25	4,80 €	5,52 €	15
90609-B3004		25	5,04 €	5,80 €	19
90609-B3005		25	5,24 €	6,03 €	23

Soporte múltiple de pared blanco

White wall extension bracket / Support blanc mural



REF	∅	U	€	€	cm
90609-B30		25	1,32 €	1,52 €	4
90609-B50		25	1,54 €	1,77 €	6
90609-B80		25	2,02 €	2,32 €	10
90609-B120		25	2,65 €	3,05 €	15
90609-B180		25	3,32 €	3,82 €	20

Muestra riel REVA MANUAL

Demo sample REVA Hand-Drawn track / Echantillon Rail REVA MANUELE



REF	∅	U	€	€	cm
M.2M		1		6,42 €	

REVA RAIL

manual & cord system



Riel RM09 Manual / Hand-Drawn RM09 Track / Rail RM09 Manuel



RM09 MANUAL

Conjuntos completos con soporte a techo (J.R107) /

Complete sets with ceiling Bracket (J.R107) /

Kits complets avec support Plafond (J.R107)

* Se sirven empalmados /
* Supplied in 2 halve /
* Fourni en 2 parts.

REF	Soportes Brackets Supports	Correderas Gliders Glisseur				
J.R1500M	2	16	1		95,28 €	150
J.R2000M	3	20	1		110,36 €	200
J.R2500M	3	26	1		124,62 €	250
J.R3000M	4	30	1		139,70 €	300
J.R3500M	4	36	1		153,96 €	350
J.R4000M	5	40	1		177,42 €	400
J.R4500M	5	46	1		183,30 €	450
J.R5000M	6	50	1		198,38 €	500
J.R5500M	6	56	1		212,64 €	550
J.R6000M*	7	60	1		227,70 €	600*
J.R6500M*	7	66	1		241,98 €	650*
J.R7000M*	8	70	1		257,06 €	700*
J.R7500M*	8	76	1		269,22 €	750*
J.R8000M*	9	80	1		286,40 €	800*
J.R8500M*	9	86	1		300,66 €	850*
J.R9000M*	10	90	1		315,76 €	900*
J.R9500M*	10	96	1		330,02 €	950*
J.R10000M*	12	100	1		346,02 €	1000*

Información General / General Information / Informations Générales

El perfil es de aluminio lacado blanco. El riel se sirve cortado a medida y preparado para el modo de apertura deseado: apertura izquierda, apertura derecha o apertura central. Correderas con ruedas permiten un deslizamiento suave y fluido de la cortina. Su largo máximo es de 12 metros mediante empalme.

The track profile is made of white anodized aluminium. The track is supplied cut-to-measure and assembled to the opening mode specified by the customer: left-side opening, right-side opening or central opening. Sliding wheels allow a smooth sliding curtain. The maximum length of the track is 12 meters using a splice or joiner.

Le rail d'aluminium anodisé blanc. Le rail est fourni coupé sur mesure avec le mode d'ouverture sollicité: vers la gauche, vers la droite ou centrale. Roues coulissantes permettent un rideau coulissant lisse et fluide. Le largeur maximum est de 12 mètres avec raccords.

- Disponible también para Sistema con ONDA PERFECTA empleando las referencias D.115 Corredera con Cordón de paso 60 mm y D.116 Corredera con Cordón con paso 80 mm. (Ref: D.115I ó D.116I = 12,40 € PVP).

- Also available with PERFECT WAVE SYSTEM, ref. D.115 Corded Glider space 60 mm and D.116 Corded Glider space 80 mm. (Ref: D.115I or D.116I = 12,40 € SRP).

- Aussi disponible avec le SYSTÈME D'ONDE PARFAITE, ref. D.115 Glisseur en Cordon pas 60 mm et D.116 Glisseur en Cordon pas 80 mm. (Ref: D.115I et D.116I = 12,40 € PDC).

- Disponible también para Sistema con CINTA ACORDEÓN empleando las referencias D.111 Cinta con Automáticos y D.112 Corredera con Cordón. (Ref: J.ROP = 7,00 € PVP)

- Available also for the RUFFLE TAPE SYSTEM by using references D.111 ruffle tape and D.112 corded runner (Ref :J.ROP = 7,00 € SRP)

- Disponible aussi avec l'option de RUBAN ACCORDEON avec les références D.111 ruban accordéon et D.112 glisseur en cordon (Ref: J.ROP = 7,00 € PDC)

Observación Curvatura / Remark on Bending / Observation Cintrage



Curvatura RM09.

J.RC - curvatura por Ángulo - 84,00 € PVP
 J.RA - curvatura por Arco - 126,00 € PVP
 El Coste incluye el curvado, el empaquetado y el sobrecosto en el envío con respecto a un envío normal dentro de territorio peninsular español.



BENDING RM09.

J.RC - bending in angle - 84,00 € SRP
 J.RA - bending in Arc - 126,00 € SRP
 The price includes the bending and the special packing. The freight charges due to the special sizes will be charged by separate in the cases of shipments outside the Spanish mainland.



CINTRAGE RM09.

J.RC - cintrage par angle - 84,00 € PVP
 J.RA - cintrage par Arc - 126,00 € PVP
 Le prix inclue le cintrage et l'emballage à cette fin. Les frais de transport par les dimensions enregistrées seront facturés séparément dans les expéditions pour les envois non péninsulaires.



- En casos en los que haya 2 o más Curvas en forma de Arco o Ángulo (el ángulo con un radio orientativo mínimo de 1,20 m), con idéntico o diferente radio en el mismo riel, este riel se servirá empleando empalmes para asegurar el deslizamiento correcto de las correderas por la zona de unión de los arcos. Cada arco se cobrará por separado al precio de 126 € PVP.
 - El cliente debe proporcionar SIEMPRE una plantilla con el arco y radio de la curvatura.
- En el caso de que el cliente no la aporte y tengamos que crearla en Altran, el importe será de 30,60 € PVP.



- In the case of 2 or more curvings in arch or angle (the angle with a radius of curvature of not less than 1.20 M) , with radius same size of different in the same track, we will supply the track with joints in order to assure the correct slide of the runners in the area of union. Every arch will be invoice by separate, price 126 € SRP.
 - Client should **provide** the physical template with the arch and the radius of the bending.
- Altran offers the possibility of create the template price 30,60 € SPR.



- Dans le cas de 2 ou plus curves en forme d'arc ou angle (l'angle avec un un rayon indicatif de courbure au moins égal à 1,20 M), avec rayon identique ou différent dans le même rail, on fournira le rail avec raccords pour sécuriser le glissement correct des glisseurs dans la zone de jonction des arcs. Chacun des arcs sera facturé séparément à un prix de 126,00 € PVP.
- Le client **toujours** doit fournir le modèle en papier avec l'arc et rayon du cintrage. A ltran offre la possibilité de créer le modèle en papier à un prix de 30,60 € PVP.

Componentes / Components / Composants

Perfil RM09

RM09 Track / Rail RM09

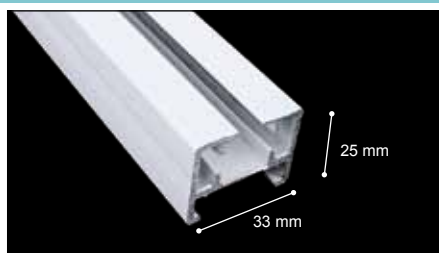

REF	∅	U	€	€	cm
J.R101		58 m		19,82 €/m	580

Cantonera

End Pulley / Bouchons Finaux



REF	∅	U	€	€	cm
J.R121		1		10,00 €	

NEW

Soporte Techo Giratorio

Round Ceiling Bracket et / Support Plafond



REF	∅	U	€	€	cm
J.R107		1		1,80 €	

* Soporte incluido en el kit / Bracket supplied in the kit / Support fourni dans le kit.

Soporte Techo Extrafuerte

Ceiling Bracket (Extrastrong) / Support Plafond Extrafort

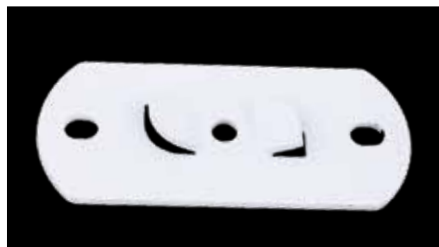

REF	∅	U	€	€	cm
J.R108		1		2,84 €	

Observación Curvatura / Remark on Bending / Observation Cintrage

Bloqueo
Cantonera

End-Pulley Stop /
Frein Rail



REF	∅	U	€	1	cm
J.R104		1		1,00 €	

Gancho Fijo
Cantonera

Static Hook En-
d-Pulley /
Crochet Fixe

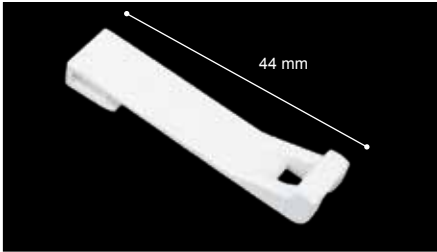

REF	∅	U	€	1	cm
J.R110		1		0,26 €	

Corredera Maestra

Master Carrier /
Chariot de
Croisement

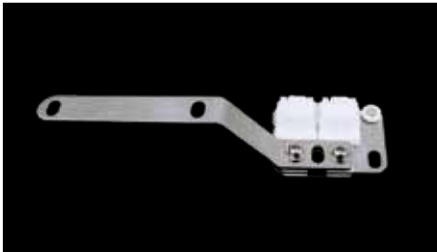

REF	∅	U	€	1	cm
J.R105		1		9,80 €	

Corredera

Runner /
Glisseur



REF	∅	U	€	1	cm
J.R106		1		0,50 €	

Marvent
SOLUCIONES PARA DECORAR VENTANAS

Protección solar creando zonas cálidas y confortables, embelleciendo el ambiente y dándole un toque personal a tu casa.

CORTINA VENECIANA DE MADERA

CORTINAS TÉCNICAS

Protección solar creando zonas cálidas y confortables, embelleciendo el ambiente y dándole un toque personal a su casa.

Ponemos a su disposición catálogos y tarifas de precios de todos los productos.



Enrollables



Noche y Día



Impresión digital



Enrollables para puertas y ventanas



Verticales



Venecianas de madera



Venecianas de aluminio



Verticales de madera



Mosquiteras

Rieles a Cordón

cord-drawn curtain tracks / rails avec corde



Marvent

SOLUCIONES PARA DECORAR VENTANAS



¿Cuántos sistemas reconoces a través de la ventana?

Riel de aluminio REVA Cordón / REVA cord-drawn Aluminium track / Rail REVA d'aluminium avec tirage Corde



Blanco
White
Blanc



Ejemplo del riel montado con codos interior y exterior.



Example of the aluminium track assembled with inner and outer elbows.
/
Exemple du rail monté avec des coudes intérieur et extérieur.

REVA CORDÓN	REF	Soportes Brackets Supports	Correderas Gliders Glisseur				
Conjuntos completos con soporte a techo (22619-202) / Complete sets with ceiling Bracket (22619-202) / Kits complets avec support Plafond (22619-202) Disponible con opción Manual / Available with Manual System / Disponible avec option Manuel Incremento para Sistema Onda Perfecta Price increase perfect wave system Hausse prix système onde parfaite D.113: 3,20 €/m D.114: 3,20 €/m	22619-MB100	2	10	6	20,76 €	23,88 €	100
	22619-MB150	3	16	6	26,36 €	30,32 €	150
	22619-MB200	3	20	6	30,92 €	35,56 €	200
	22619-MB250	4	26	6	36,48 €	41,96 €	250
	22619-MB300	4	30	6	42,26 €	48,60 €	300
	22619-MB350	5	36	6	47,98 €	55,18 €	350
	22619-MB400	5	40	6	54,20 €	62,33 €	400
	22619-MB450	5	46	6	60,04 €	69,05 €	450
	22619-MB500	6	50	6	64,92 €	74,66 €	500
	22619-MB600	6	60	60	6	78,28 €	90,03 €

Componentes / Components / Composants



REF					
22619-12141BL		60 m	5,52 €/m	6,35 €/m	600



REF					
22619-202		100	0,42 €	0,49 €	

* Soporte incluido en el kit / Bracket supplied in the kit / Support fourni dans le kit.

Componentes / Components / Composants

Conjunto
corredera
maestra

Master
carrier set /
Kit porteur
principal

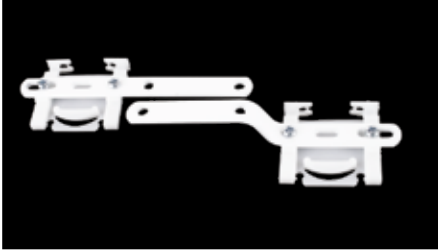

REF	∅	U	€	€	cm
22619-206		25	2,34 €	2,69 €	

Corredera
Maestra
parte curva

Master carrier
curved part /
Porteur principal
partie courbée

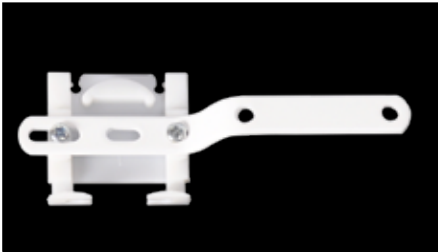

REF	∅	U	€	€	cm
22619-208		25	1,32 €	1,52 €	

Correderas

Glider /
Glisseur



REF	∅	U	€	€	cm
22619-201		1000	0,15 €	0,18 €	

Empalme

Splice /
Raccordeur

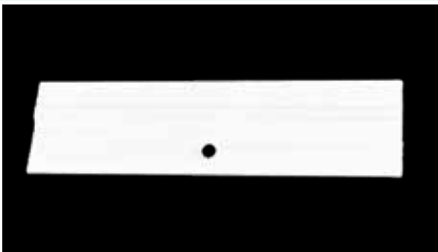

REF	∅	U	€	€	cm
22619-203		25	1,64 €	1,89 €	

Juego de
cantoneras

End pulley set /
Jeux d'angles

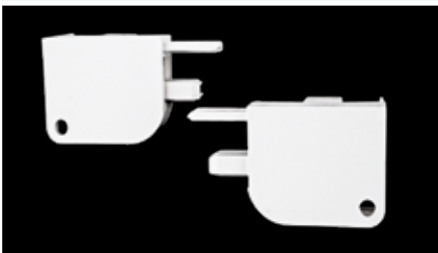

REF	∅	U	€	€	cm
22619-207		25	2,76 €	3,17 €	

* Las cantoneras tienen un diseño especial para ser utilizadas como soporte y así reducir el número de soportes empleados. / The end pulleys have a special design aiming to reduce the number of brackets to be used. / Les plaques de couche ont un dessin spécial pour réduire le nombre de supports à être employés.

Codo rincón 90°

90° Inner elbow /
Coude intérieur
90°

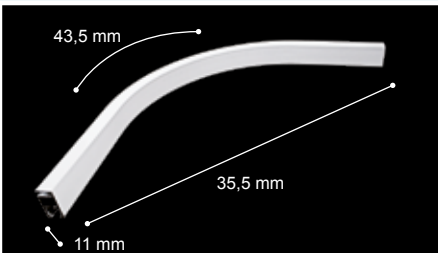

REF	∅	U	€	€	cm
22619-205		10	14,84 €	17,07 €	

Codo esquina 90°

90° Outer elbow /
Coude extérieur
90°

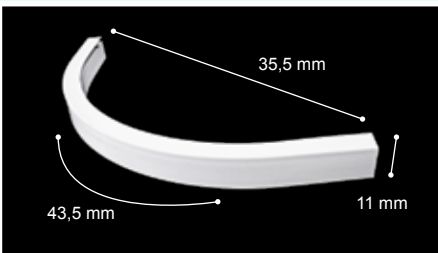

REF	∅	U	€	€	cm
22619-204		10	14,84 €	17,07 €	

Rollo 250 m. de
cordón 3 mm.

Cord roll of 3 mm.
(500m). /
Rouleau 500m.
corde 3mm.



REF	∅	U	€	€	m
22619-12P		250	0,13 €		250

Componentes / Components / Composants

Tensor rectangular

Cordweight /
Tendeur
rectangulaire



	∅	U	€	€	cm
22619-1150		25	1,48 €	1,78 €	

Contrapeso mini
blanco

Mini-cordweight
white /
Mini-contrepoids
blanc



REF	∅	U	€	€	cm
90977-1110BL		25	1,36 €	1,56 €	

Tirador

Wand /
Lance rideau



REF	∅	U	€	€	cm
90609-T1		25	2,00 €	2,30 €	100
90609-T1150		25	3,14 €	3,61 €	150

Soporte múltiple de
pared extrafuerte

Wall extension
bracket
(extrastrong) /
Support mur
extrafort



REF	∅	U	€	€	cm
90609-B3001		25	3,36 €	3,86 €	7
90609-B3002		25	4,04 €	4,65 €	11
90609-B3003		25	4,80 €	5,52 €	15
90609-B3004		25	5,04 €	5,80 €	19
90609-B3005		25	5,24 €	6,03 €	23

Soporte múltiple de
pared blanco

White wall
extension bracket /
Support blanc
mural



REF	∅	U	€	€	cm
90609-B30		25	1,32 €	1,52 €	4
90609-B50		25	1,54 €	1,77 €	6
90609-B80		25	2,02 €	2,32 €	10
90609-B120		25	2,65 €	3,05 €	15
90609-B180		25	3,32 €	3,82 €	20

Muestra REVA
CORDÓN

Demo sample
Reva CORD track /
Echantillon
kit Reva CORDON



REF	∅	U	€	€	cm
M-2		1		13,08 €	

Riel EXTENSIBLE SERIE 1100 a Cordón / EXTENDIBLE Cord track Serie 1100 / Rail EXTENSIBLE avec Corde Serie 1100



Riel EXTENSIBLE hierro Serie 1100 A TECHO /
Iron extendible rail 1100 range with CEILING installation /
Rail extendible en fer série 1100 avec installation PLAFOND.





EXTENSIBLE	REF	Soporte Techo Ceiling Brackets / Support Plafond		Correderas Gliders Glisseur	U	€	€	cm
		I.100I (Int.)	I.100E (Int.)					
Kit completo con accesorios para montaje A TECHO /	90961-3821R	0	0	10	20	10,42 €	11,98 €	70-125
Complete kit with CEILING accesories /	90961-3823R	0	0	12	20	11,56 €	13,29 €	90-156
Kit complet avec accesories de PLAFOND	90961-3825R	0	1	24	20	15,08 €	17,34 €	140-256
	90961-3826R	1	1	36	20	18,58 €	21,37 €	190-356
	90961-3827R	1	2	46	10	22,64 €	26,04 €	240-456



Riel EXTENSIBLE hierro Serie 1100 A FRENTE /
Iron extendible rail 1100 range with WALL installation. /
Rail extendible en fer série 1100 avec installation MUR.



EXTENSIBLE	REF	Soporte Lateral Wall Bracket / Support Mural I.10	Soporte Techo Ceiling Brackets / Support Plafond		Correderas Gliders Glisseur	U	€	€	cm
			I.20I (Int.)	I.20E (Int.)					
Kit completo con accesorios para montaje a frente /	90961-3821	2	0	0	10	20	11,96 €	13,75 €	70-125
Complete kit with WALL accesories /	90961-3823	2	0	0	12	20	13,32 €	15,32 €	90-156
Kit complet avec accesories de MURAL	90961-3825	2	0	1	24	20	17,38 €	19,99 €	140-256
	90961-3826	2	1	1	36	20	21,68 €	24,93 €	190-356
	90961-3827	2	1	2	46	10	26,42 €	30,38 €	240-456

-  Las cantoneras tienen un diseño especial para ser utilizadas como soporte y así reducir el número de soportes empleados.
-  The end pulleys have a special design aiming to reduce the number of brackets to be used. /
-  Les plaques de couche ont un dessin spécial pour réduire le nombre de supports à être employés.

Componentes / Components / Composants

Soporte lateral
sencillo 70 mm.

Single wall bracket
70 mm. /
Support mural
70 mm.



	∅	U	€	€	cm
I.10		20 pares	2,36 €	2,83 €	

* Soporte incluido en el kit /
Bracket supplied in the kit / Support fourni dans le kit.

Soporte lateral
doble 100 mm.

Double wall bracket
100 mm. /
Support mural
double 100 mm.



	∅	U	€	€	cm
I.1		20 pares	3,36 €	4,03 €	

Soporte central
sencillo 80 mm.
Interior y Exterior

Single intermediate
bracket (Int. & Ext.) /
Support intermediaire
80 mm(Int. et Ext.)



REF	∅	U	€	€	cm
I.20I		20	1,62 €	1,94 €	
I.20E		20	1,62 €	1,94 €	

* Soporte incluido en el kit /
Bracket supplied in the kit / Support fourni dans le kit.

Soporte central
doble 100 mm.
(interior)

Double intermediate
bracket 100mm.(int)/
Double support
intermediaire
100 mm. (int)



REF	∅	U	€	€	cm
I.2I		20	2,02 €	2,42 €	

Soporte central
doble 100 mm.
(exterior)

Double intermediate
bracket 100mm(ext.)/
Double support
intermediaire
100 mm. (ext)



REF	∅	U	€	€	cm
I.2E		20	2,02 €	2,42 €	

Soporte techo
sencillo 20mm
(interior)

Single
Ceiling Support
20mm. (interior) /
Support plafond
20mm. (interieur)



REF	∅	U	€	€	cm
I.100I		20	0,78 €	0,94 €	

* Soporte incluido en el kit /
Bracket supplied in the kit / Support fourni dans le kit.

Soporte techo
sencillo 20mm
(exterior)

Single ceiling
Support
20mm. (ext.) /
Support plafond
20mm. (exterieur)



REF	∅	U	€	€	cm
I.100E		20	0,78 €	0,94 €	

* Soporte incluido en el kit /
Bracket supplied in the kit / Support fourni dans le kit.

Tensor perilla

Cord weighted
tassel /
Gland pour corde







REF	∅	U	€	€	cm
I.9		50	1,16 €	1,39 €	

Riel EXTENSIBLE SERIE M / EXTENDIBLE track Serie M / Rail EXTENSIBLE Serie M



Blanco
White
Blanc

EXTENSIBLE SERIE M Kit completo con accesorios para montaje A TECHO / Complete kit with CEILING accesories / Kit complet avec accesories de PLAFOND	REF				
		90961-M7212I	20	12,98 €	
	90961-M1630I	20	15,60 €		90-156
	90961-M2138I	20	19,24 €		140-256
	90961-M7212I	10	23,20 €		190-356

CORTINAS ENROLLABLES

Ponemos a disposición de nuestros clientes una amplia gama de tejidos técnicos para cortinas enrollables. Solicite catálogos y tarifas.



Marvent
SOLUCIONES PARA DECORAR VENTANAS

Rieles Motorizados

motorized curtain tracks / rails motorisés



Marvent

SOLUCIONES PARA DECORAR VENTANAS



Rieles Motorizados con aplicación domótica



RM09-43

**Batería recargable
con energía solar.**

Sistema RM09 Motorizado / RM09 Motorized System / Rail Sintra Tirage Corde et Manuel



*No incluye mandos.
Dependiendo del motor elegido para domotizar el sistema RM09, necesitaremos emplear o no, el cable telefónico con conector RJ9 (no incluido), independientemente de si se instala con o sin el pulsador J.R112. /

*Do not include remote control. Depending on the motor chosen for the home automation use of the RM09 system, a telephone cord with RJ9 plug (not included) will be needed or not, regardless of the installation with or without the wall switch J.R112. /

Télécommande ne pas compris. En fonction du moteur choisi pour l'utilisation domotique du système RM09, le cordon téléphonique avec connecteur RJ9 (non compris) sera nécessaire ou non, indépendamment de l'installation avec ou sans interrupteur mural J.R112.



 El Riel Motorizado es un sistema para desplazar las cortinas mediante el uso de un mando a distancia o de un pulsador.

Las opciones en motores que ponemos a tu disposición cubren cualquier necesidad existente en la decoración de un hogar, oficina o incluso en teatros como ya se ha empleado para los telones. La calidad del aluminio del Riel RM09 y de los Motores, le permite al instalador o decorador emplear confeccionar cortinas de un peso alto.

Además el perfil del riel permite curvarse lo que aumenta las posibilidades de este excelente producto número uno en ventas por su precio, su versatilidad y su resistencia.

Los 5 motores exclusivos para emplear en rieles, disponen de diferentes potencias, diferentes sistemas para conectarse a la domótica del hogar incluso diferentes opciones de carga como la eléctrica o la solar (más acorde con las energías renovables y las necesidades ecológicas actuales).

 The motorized track is a system to slide curtains through the use of a remote control or a wall switch.

The multiple options we make available cover all domestic decoration needs, moreover offices or even theatres as we have already done with the automation of backdrops. The quality of the RM09 track and the motorized systems permit the Installer or Decorators to be able to use heavy duty curtains.

Furthermore, the track can be bent or curved increasing the possibilities of this top-selling product, already an excellent option due to its price, versatility and resistance.

The 5 exclusive motorized track systems are presented in different engine powers, multiple choices for home automation application, and even several charging sources such as the traditional electric supply or the solar power (more in line with the renewable sources and current ecologic needs).

 Le rail motorisé est un système pour coulisser des rideaux à l'aide d'une télécommande ou d'un interrupteur mural.

Les multiples options que nous proposons couvrent tous les besoins de décoration intérieure, en plus des bureaux ou même des théâtres, comme nous l'avons déjà fait avec l'automatisation des toiles. La qualité du rail RM09 et les systèmes motorisés permettent à l'installateur ou aux décorateurs d'utiliser des rideaux pour travaux lourds.

En outre, le rail peut être pliée ou courbée augmentant les possibilités de ce produit numéro 1 des ventes, déjà une excellente option en raison de son prix, sa polyvalence et sa résistance. Les 5 systèmes motorisés exclusifs sont présentés dans différentes puissances de moteur, choix multiples pour l'application de domotique, et même plusieurs sources de charge telles que l'alimentation électrique traditionnelle ou l'énergie solaire (plus conforme aux sources renouvelables et aux besoins écologiques actuels).

RIEL RM09 MOTORIZADO

Tablas de Pesos y Curvas / Weight and curvature options table / Tableau de poids et de courbures

RM09-43 Batería

Características / Features / Caractéristiques	Opciones / Options / Options	Radio / Radius / Rayon	2 m	4 m	6 m	8 m	12 m
		0°	40 Kg	30 Kg	25 Kg	20 Kg	-
		90°	30 Kg	25 Kg	20 Kg	10 Kg	-
		X°	30 Kg	25 Kg	20 Kg	10 Kg	-
		90° x 2	-	-	-	-	-

NEW

RM09-46

Características / Features / Caractéristiques	Opciones / Options / Options	Radio / Radius / Rayon	2 m	4 m	6 m	8 m	12 m
		0°	50 Kg	40 Kg	35 Kg	25 Kg	15 Kg
		90°	35 Kg	30 Kg	20 Kg	-	-
		X°	30 Kg	30 Kg	20 Kg	-	-
		90° x 2	25 Kg	20 Kg	10 Kg	-	-

NEW

RM09-TA

Características / Features / Caractéristiques	Opciones / Options / Options	Radio / Radius / Rayon	2 m	4 m	6 m	8 m	12 m
		0°	60 Kg	50 Kg	40 Kg	30 Kg	20 Kg
		90°	50 Kg	40 Kg	30 Kg	20 Kg	-
		X°	50 Kg	40 Kg	30 Kg	20 Kg	-
		90° x 2	30 Kg	20 Kg	10 Kg	-	-

RM09-92

Características / Features / Caractéristiques	Opciones / Options / Options	Radio / Radius / Rayon	2 m	4 m	6 m	8 m	12 m
		0°	50 Kg	40 Kg	35 Kg	25 Kg	15 Kg
		90°	40 Kg	30 Kg	20 Kg	10 Kg	-
		X°	40 Kg	30 Kg	20 Kg	10 Kg	-
		90° x 2	30 Kg	20 Kg	10 Kg	-	-

NEW

RM09-95 conectado por cable eléctrico / Electric cable wired system / Système raccordé à fil électrique

Características / Features / Caractéristiques	Opciones / Options / Options	Radio / Radius / Rayon	2 m	4 m	6 m	8 m	12 m
		0°	50 Kg	30 Kg	35 Kg	25 Kg	15 Kg
		90°	40 Kg	30 Kg	20 Kg	10 Kg	-
		X°	40 Kg	30 Kg	20 Kg	10 Kg	-
		90° x 2	30 Kg	20 Kg	10 Kg	-	-

NEW

RM09-95 conectado por cable telefónico / Telephone cable wired system / Système raccordé à fil telefonique

Características / Features / Caractéristiques	Opciones / Options / Options	Radio / Radius / Rayon	2 m	4 m	6 m	8 m	12 m
		0°	80 Kg	60 Kg	50 Kg	40 Kg	30 Kg
		90°	70 Kg	50 Kg	40 Kg	30 Kg	20 Kg
		X°	70 Kg	50 Kg	40 Kg	30 Kg	20 Kg
		90° x 2	40 Kg	30 Kg	20 Kg	10 Kg	-

Descripción Leyendas / Caption description / Description de la légende



Mando a distancia /
Remote Control /
Télécommande

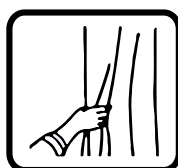

Toque Automático /
Touch Control /
Contrôle tactile



Manipulación sin
corriente eléctrica /
Manipulation without
electricity supply /
Application sans
alimentation électrique

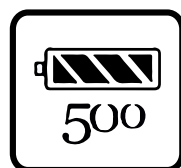

Nº de ciclos /
Number of cycles /
Nombre de cycles

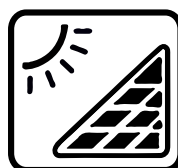

Batería recargable
con energía solar /
Solar-charged Battery/
Batterie rechargeable
par l'énergie solaire

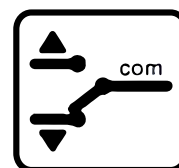

Domotización por
cable telefónico /
Automation through
phone cable /
Domotique via
câble téléphonique

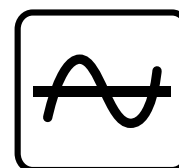

Domotización por
cable eléctrico /
Automation through
electrical cable
connection /
Domotique via
câble électrique

Características Generales RM09 / RM09 Main features / RM09 caractéristiques principales

El Riel RM09 es un sistema de riel eléctrico de última generación apto tanto para uso doméstico, comercial o industrial debido a sus altas prestaciones. El perfil es de aluminio lacado blanco. Este perfil se puede montar empleando 5 motores de diferentes potencias y características que están explicadas en la tabla.

Características Generales:

- Disponen de un Mando a Distancia de 7 canales y pulsador de pared de 2 canales (según modelo). El mando a distancia tiene un alcance de 30 metros. La programación del sistema es muy fácil y rápida.
- Funcionamiento sin corriente eléctrica, en el caso de cortes de luz o corriente eléctrica la cortina se puede accionar manualmente.
- El motor está preparado para incorporarlo a un sistema domótico de forma fácil.
- El riel se sirve cortado a medida y preparado para el modo de apertura deseado: apertura izquierda, apertura derecha o apertura central. El motor se puede colocar a la izquierda o a la derecha del riel según se desee.
- El motor es muy silencioso y las correderas con ruedas permiten un deslizamiento suave y fluido de la cortina.
- Su largo máximo es de 12 metros mediante empalme.
- Permite 2 posiciones intermedias programables.
- El Receptor está integrado en el motor.
- El Final de Carrera es electrónico.
- Memoria de programación en ausencia de energía eléctrica.
- Dispositivo térmico de protección contra sobrecargas eléctricas.
- Parada automática del sistema al finalizar su recorrido.
- Motor asincrónico, libre de interferencias.
- Funciona por correa dentada y soporta hasta 80 kg de peso (según modelo) de cortina según las medidas indicadas en la tabla.

Altran ofrece una **Garantía de 2 años** para todos sus Motores, a partir de la fecha de factura, salvo mal uso o rotura por parte del cliente-usuario-instalador.

RM09 is a high-tech electric motorized track system suitable for domestic and commercial or industrial installation. The track profile is made of white anodized aluminium. **This system can function with 5 motors of different powers and features indicated in the data table.**

It is operated with a 7-channel remote control and/or 2-channel wall switch. The remote has a range of 30 meters. Programming the system is very easy and fast. The system includes a "touch-control" mode that allows the curtain to be opened or closed without controls by simply pulling gently on the fabric. This function can be cancelled whenever desired. The curtains can be drawn manually when there is power failure. The motor can be connected to home automation easily. The track is supplied cut-to-measure and assembled to the opening mode specified by the customer: left-side opening, right-side opening or central opening. The motor can be easily installed on the left side or the right side of the track. The motor is extremely quiet and the wheeled runners glide smoothly and noiselessly along the track. - Slow start and slow stop with two intermediate functions. Built-in radio receiver. Full automatic setting of the limits. Program memory when power failure. Overvoltage protection thermal device. Automatic slow stop at run end. Interference free, asynchronous motor.

Transmission by driving belt, depending on the motor model, the system can stand up to 80 kgs-curains following table data. The maximum length of the track is 12 meters using a splice or joiner.

Altran offers a 2 year **warranty** for all motors, from the date of invoice, unless misuse or failure by the customer-user-installer.

Le rail **RM09** est un système high-tech destiné à l'usage de particuliers comme pour des installations commerciales ou industrielles grâce à ses grandes prestations. Le rail est fabriqué à partir d'aluminium laqué blanc. **Ce système peut fonctionner avec 5 moteurs de différentes puissances et caractéristiques indiquées dans le tableau technique.**

Il est équipé d'une télécommande de 7 canaux et d'un interrupteur mural de 2 canaux. La télécommande a une portée de 30 mètres. La programmation du système est très simple et rapide. Ce système comprend la fonction de "touche automatique" qui permet d'ouvrir ou fermer le rideau sans commande, en tirant légèrement sur le rideau avec la main. Cette fonction peut être enlevée en cas de besoin. Fonctionnement sans courant électrique. En cas de coupure de courant, le rideau peut être actionné manuellement. Il est possible d'adapter un système de domotique avec ce moteur. Le rail est fourni coupé sur mesure avec le mode d'ouverture sollicité: vers la gauche, vers la droite ou centrale. Le moteur peut être placé à droite ou à gauche sur le rail. Le moteur est très silencieux et les glisseurs permettent un glissement léger et fluide du rideau. Le largeur maximum est de 12 mètres avec raccords. Début et fin de course lents avec 2 fonctions d'arrêt intermédiaires. Récepteur radio intégré. Réglage automatique du début et fin de course. Mémoire de programme en cas de panne de tension. Dispositif thermique de protection de surtension. Arrêt lente automatique fin de course. Moteur asynchrone, exempte d'interférences. Transmission par corroie dentée, selon le modèle capable de supporter rideaux jusqu'à 80 kgs., voir tableau technique.

Altran offre une **garantie** de 2 ans pour tous les moteurs, à partir de la date de la facture, sauf utilisation incorrecte ou rupture de la part du client-utilisateur-installateur.

Especificaciones técnicas / Technical characteristics / Caractéristiques techniques

Modelo Model / Modele	Voltaje Rated Voltage / Tension nominale	Frecuencia Rated Frequency / Fréquence nominale	Consumo Rated Current / Courant nominale	Potencia Rated Torque / Couple nominal	RPM Rated Speed / Vitesse nominale	Velocidad Speed / Vitesse	Tiempo de funcionamiento Running Time / Temps de course	Protección IP Grade / Protection
RM09-43 Bat	12,6 VCD	DC	1,50 A	0,8 NM	100	0,13 m/s	S3 50%	IP41
RM09-46	100-240 VAC	50/60 Hz	0,40 A -1,2 A	1 NM	118	0,17 m/s	S3 50%	IP42
RM09-TA	100-240 VAC	50/60 Hz	0,35 A -1,5 A	1,2 NM	85-76	0,11 m/s	S3 50%	IP41
RM09-92	100-240 VAC	50/60 Hz	0,35 A -1,5 A	1 NM	95	0,13 m/s	S3 50%	IP41
RM09-95 (Elec.)	100-240 VAC	50/60 Hz	0,35 A -1,5 A	1 NM	104-100	0,14 m/s	S3 50%	IP41
RM09-95 (Tel.)	100-240 VAC	50/60 Hz	0,45 A -1,5 A	1,5-2,0 NM	86-70	0,12 m/s	S3 50%	IP41

Conjuntos Motorizados Completos / Complete Motorized sets / Kits Motorisés completos

NEW		NEW		NEW		NEW		NEW				
RM09-43		RM09-46		RM09-TA		RM09-92		RM09-95				
REF		REF		REF		REF		REF				
J.B1500	540,02 €	J.P1500	299,44 €	J.R1500	495,10 €	J.D1500	450,42 €	J.S1500	574,88 €	3	16	150
J.B2000	569,88 €	J.P2000	329,88 €	J.R2000	523,82 €	J.D2000	480,28 €	J.S2000	605,52 €	3	20	200
J.B2500	602,94 €	J.P2500	364,16 €	J.R2500	550,74 €	J.D2500	513,34 €	J.S2500	635,38 €	4	26	250
J.B3000	632,80 €	J.P3000	394,62 €	J.R3000	579,48 €	J.D3000	543,20 €	J.S3000	664,82 €	4	30	300
J.B3500	665,86 €	J.P3500	428,90 €	J.R3500	606,40 €	J.D3500	576,26 €	J.S3500	694,50 €	5	36	350
J.B4000	697,78 €	J.P4000	461,88 €	J.R4000	635,12 €	J.D4000	608,18 €	J.S4000	724,96 €	6	40	400
J.B4500	730,84 €	J.P4500	496,14 €	J.R4500	662,04 €	J.D4500	641,24 €	J.S4500	754,66 €	7	46	450
J.B5000	760,70 €	J.P5000	526,60 €	J.R5000	690,80 €	J.D5000	671,10 €	J.S5000	785,12 €	7	50	500
J.B5500	793,76 €	J.P5500	560,88 €	J.R5500	717,32 €	J.D5500	704,16 €	J.S5500	814,80 €	8	56	550
J.B6000*	832,26 €	J.P6000*	599,80 €	J.R6000*	754,06 €	J.D6000*	742,66 €	J.S6000*	858,54 €	8	60	600*
J.B6500*	865,32 €	J.P6500*	634,10 €	J.R6500*	781,52 €	J.D6500*	775,72 €	J.S6500*	882,22 €	9	66	650*
J.B7000*	897,24 €	J.P7000*	667,06 €	J.R7000*	809,74 €	J.D7000*	807,64 €	J.S7000*	912,68 €	10	70	700*
J.B7500*	930,30 €	J.P7500*	701,34 €	J.R7500*	836,66 €	J.D7500*	840,70 €	J.S7500*	942,36 €	11	76	750*
J.B8000*	960,16 €	J.P8000*	731,80 €	J.R8000*	865,38 €	J.D8000*	870,56 €	J.S8000*	972,82 €	11	80	800*
J.B8500*	993,22 €	J.P8500*	766,08 €	J.R8500*	892,82 €	J.D8500*	903,62 €	J.S8500*	1.002,50 €	12	86	850*
J.B9000*	1.025,14 €	J.P9000*	799,04 €	J.R9000*	900,04 €	J.D9000*	935,54 €	J.S9000*	1.032,96 €	13	90	900*
J.B9500*	1.056,16 €	J.P9500*	830,82 €	J.R9500*	947,96 €	J.D9500*	966,56 €	J.S9500*	1.062,66 €	13	96	950*
J.B10000*	1.088,06 €	J.P10000*	917,60 €	J.R10000*	971,38 €	J.D10000*	996,16 €	J.S10000*	1.093,12 €	14	100	1000*

Conjuntos completos con soporte a techo (J.R107)
Complete sets with ceiling bracket (J.R107) /
Kits complets avec support plafond (J.R107)

* Se sirven empalmados a partir de 570 mm.
Supplied in 2 halves from 570 mm. /
Fourni en 2 parties a partir 570 mm.

- Disponible también para Sistema con ONDA PERFECTA empleando las referencias D.115 Corredera con Cordón de paso 60 mm y D.116 Corredera con Cordón con paso 80 mm. (Ref: D.115I ó D.116I = 12,40 € PVP).

- Disponible también para Sistema con CINTA ACORDEÓN empleando las referencias D.111 Cinta con Automáticos y D.112 Corredera con Cordón. (Ref: J.ROP = 7,00 € PVP)

- Also available with PERFECT WAVE SYSTEM, ref. D.115 Corded Glider space 60 mm and D.116 Corded Glider space 80 mm. (Ref: D.115I or D.116I = 12,40 € SRP).

- Available also for the RUFFLE TAPE SYSTEM by using references D.111 ruffle tape and D.112 corded runner (Ref :J.ROP = 7,00 € SRP)

- Aussi disponible avec le SYSTÈME D'ONDE PARFAITE, ref. D.115 Glisseur en Cordon pas 60 mm et D.116 Glisseur en Cordon pas 80 mm. (Ref: D.115I et D.116I = 12,40 € PDC).

- Disponible aussi avec l'option de RUBAN ACCORDEON avec les références D.111 ruban accordéon et D.112 glisseur en cordon (Ref: J.ROP = 7,00 € PDC)

Observación sobre Curvatura del Riel / Remark on Track Bending / Observation Cintrage du Rail

Curvatura RM09

J.RC - curvatura por Ángulo - 84,00 € PVP
 J.RA - curvatura por Arco - 126,00 € PVP

El Coste incluye el curvado, el empaquetado y el sobrecosto en el envío con respecto a un envío normal dentro de territorio peninsular español.

Bending RM09

J.RC - bending in angle - 84,00 € SRP
 J.RA - bending in Arc - 126,00 € SRP

The price includes the bending and the special packing. The freight charges due to the special sizes will be charged by separate in the cases of shipments outside the Spanish mainland.

Cintrage RM09

J.RC - cintrage par angle - 84,00 € PVP
 J.RA - cintrage par Arc - 126,00 € PVP

Le prix inclue le cintrage et l'emballage à cette fin. Les frais de transport par les dimensions enregistrées seront facturés séparément dans les expéditions pour les envois non péninsulaires.

 - En casos en los que haya 2 o más Curvas en forma de Arco o Ángulo (el ángulo con un radio orientativo mínimo de 80 cm), con idéntico o diferente radio en el mismo riel, este riel se servirá empleando empalmes para asegurar el deslizamiento correcto de las correderas por la zona de unión de los arcos. Cada arco se cobrará por separado al precio de 126 € PVP.

- El cliente debe proporcionar SIEMPRE una plantilla con el arco y radio de la curvatura. En el caso de que el cliente no la aporte y tengamos que crearla en Altran, el importe será de 30,60 € PVP.

 - In the case of 2 or more curvings in arch or angle (the angle with a radius of curvature of not less than 80 cm), with radius same size of different in the same track, we will supply the track with joints in order to assure the correct slide of the runners in the area of union. Every arch will be invoice by separate, price 126 € SRP.

- Client should provide the physical template with the arch and the radius of the bending. Altran offers the possibility of create the template price 30,60 € SPR.

 - Dans le cas de 2 ou plus curves en forme d'arc ou angle (l'angle avec un un rayon indicatif de courbure au moins égal à 80 cm), avec rayon identique ou différent dans le même rail, on fournira le rail avec raccords pour sécuriser le glissement correct des glisseurs dans la zone de jonction des arcs. Chacun des arcs sera facturé séparément à un prix de 126,00 € PVP.





- Le client TOUJOURS doit fournir le modèle en papier avec l'arc et rayon du cintrage. Altran offre la possibilité de créer le modèle en papier à un prix de 30,60 € PVP.

Accesorios / Accessories / Accessoires

Motor RM09-43
Batería





Motor RM09-43
batería /
Moteur RM09-43
batterie

REF	∅					NEW
J.R96		1		326,00 €		

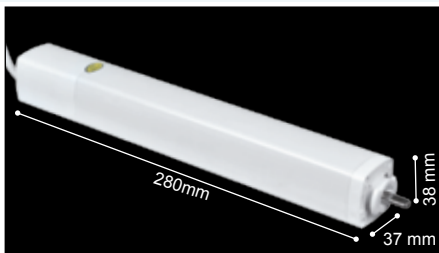
Motor RM09-46





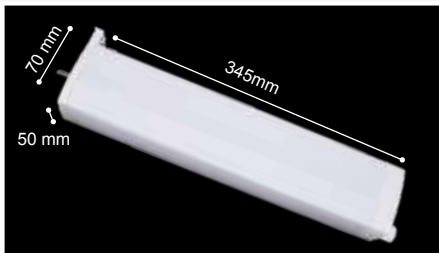

Motor RM09-46 /
Moteur RM09-46

REF	∅					NEW
J.R97		1		150,00 €		

Motor RM09-TA



Motor RM09-TA /
Moteur RM09-TA



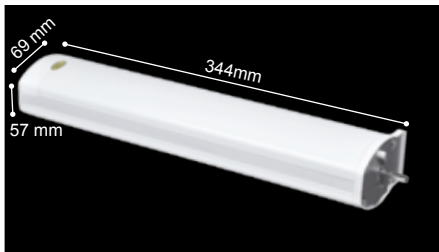

REF	∅					NEW
J.R100		1		326,00 €		

* Para domotizar el sistema RM09, con o sin el pulsador J.R112, es necesario emplear el cable telefónico con conector RJ9 (no incluido). / For home automation purposes of the RM09 system, with or without the wall switch J.R112, it is necessary to use the telephone cable with plug RJ9 (not included). / Pour domotiser le système RM09, l'utilisation du câble téléphonique avec connecteur RJ9 est nécessaire (ne pas inclus).

Motor RM09-92



Motor RM09-92 /
Moteur RM09-92

REF	∅					NEW
J.R95		1		268,80 €		

RIEL RM09 MOTORIZADO

Accesorios / Accessories / Accessoires

Motor RM09-95

Motor RM09-95 /
Moteur RM09-95

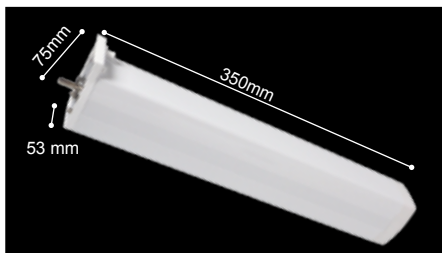

REF	∅	U	€	€	cm
J.R99		1		415,00 €	

* Para domotizar el sistema RM09, con o sin el pulsador J.R112, es necesario emplear el cable telefónico con conector RJ9 (no incluido). / For home automation purposes of the RM09 system, with or without the wall switch J.R112, it is necessary to use the telephone cable with plug RJ9 (not included). / Pour domotiser le système RM09, l'utilisation du câble téléphonique avec connecteur RJ9 est nécessaire (ne pas inclus).

Mando a Distancia

Remote Control /
Télécommande

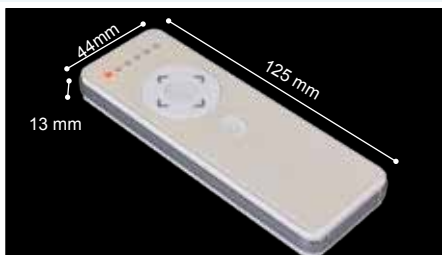

REF	∅	U	€	€	cm
J.R113		1		51,74 €	

Pulsador Doble /
Double Motor Wall
Switch /
Interrupteur Doble

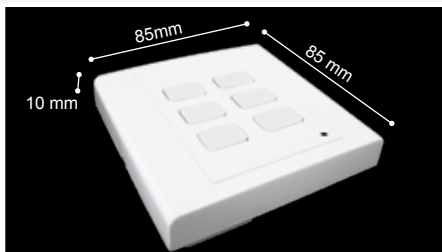

REF	∅	U	€	€	cm
J.R112		1		31,00 €	

* Se sirve con caja de plástico para instalar el soporte empotrado en la pared. / Supplied with plastic box to insert the bracket into the wall. / Fourni avec boîte en plastic pour insérer le support au mur.

Perfil RM09

Track RM09 /
Rail RM09

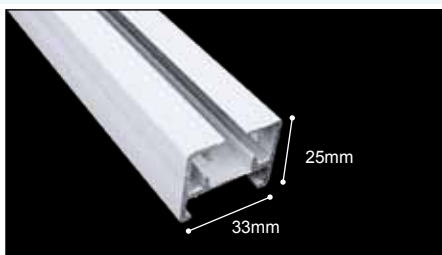

REF	∅	U	€	€	cm
J.R101		1	-	19,82 €/m	600

Cantонера Motor
RM09-TA (J.R100)

End Pulley
Motor RM09-TA
(J.R100) /
Bouchons Finaux
Motor RM09-TA
(J.R100)

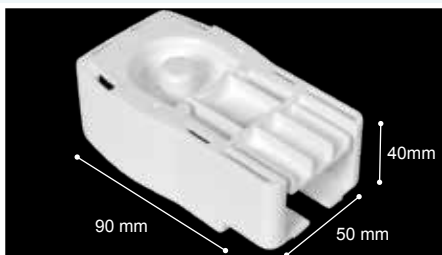

REF	∅	U	€	€	cm
J.R102		1		15,80 €	

Cantонера Motor
RM09-95 (J.R99)

End Pulley
Motor RM09-95
(J.R99) /
Bouchons Finaux
Motor RM09-95
(J.R99)

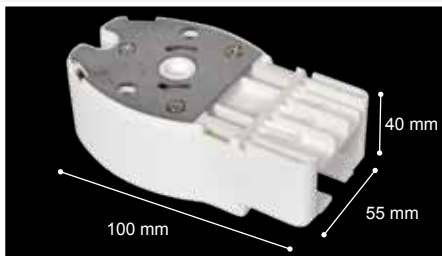

REF	∅	U	€	€	cm
J.R120		1		17,70 €	

Cantонера Motor
RM09-43 y RM09-46

End Pulley
Motor RM09-43 &
RM09-46 (J.R122) /
Bouchons Finaux
Motor RM09-43 et
RM09-46 (J.R122)

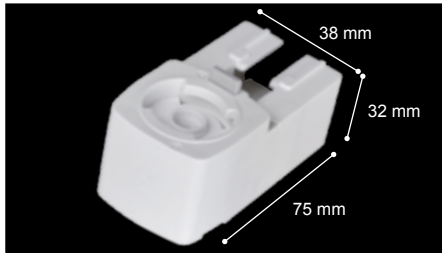

REF	∅	U	€	€	cm
J.R122		1		8,80 €	

NEW

Soporte Techo
Extrafuerte

Ceiling Bracket
(Extrastrong) /
Support Plafond
Extrafort



REF	∅	U	€	€	cm
J.R108		1		2,84 €	

Accesorios / Accessories / Accessoires

SopORTE Techo
Giratorio

RoundCeiling
Bracket /
SupportPlafond



REF	∅	U	€	€ ¹	cm
J.R107		1		1,80 €	

* Soporte incluido en el kit / Bracket supplied in the kit / Support fourni dans le kit.

Bloqueo
Cantonera

End-Pulley Stop /
Frein Rail



REF	∅	U	€	€ ¹	cm
J.R104		1		1,00 €	

Gancho Fijo
Cantonera

Static Hook
End-Pulley /
CrochetFixe



REF	∅	U	€	€ ¹	cm
J.R110		1		0,26 €	

Corredera Maestra

Master Carrier /
Chariot de
Croisement



REF	∅	U	€	€ ¹	cm
J.R105		1		9,80 €	

Corredera

Runner /
Glisseur



REF	∅	U	€	€ ¹	cm
J.R106		1		0,50 €	

Empalme

Splice /
Raccordeur



REF	∅	U	€	€ ¹	cm
J.R109		1		6,64 €	

Correa Dentada

Drive Belt /
Courroie Dentelée

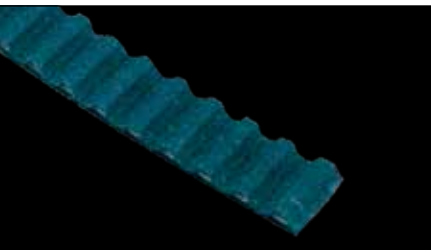

REF	∅	U	€	€ ¹	cm
J.R103		1		18,20 €	

Soporte Múltiple de
Pared Extrafuerte

Wall Extension
Bracket (Extrastrong) /
Support Mural
Extrafort



REF	∅	U	€	€ ¹	cm
90609-B3001		25	3,36 €	3,86 €	7
90609-B3002		25	4,04 €	4,65 €	11
90609-B3003		25	4,80 €	5,52 €	15
90609-B3004		25	5,04 €	5,80 €	19
90609-B3005		25	5,24 €	6,03 €	23

RIEL RM09 MOTORIZADO

Accesorios / Accessories / Accessoires

Corredera con Cordón de paso 60 mm

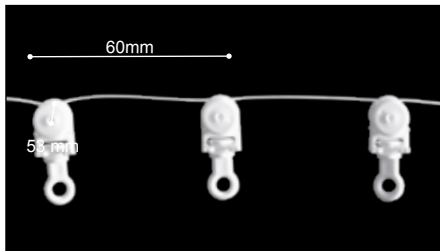

Corded runner space 60 mm / Glisseur en corde pas 60 mm

REF	∅				
D.115		1		17,14 €/m	

Corredera con Cordón de paso 80 mm

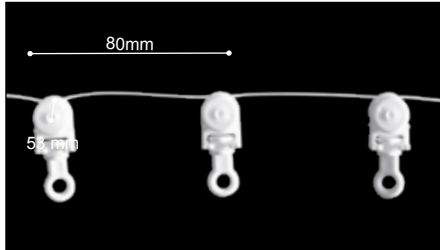

Corded runner space 80 mm / Glisseur en corde pas 80 mm

REF	∅				
D.116		1		17,14 €/m	

El perfecto equilibrio entre material y diseño



Marvent

SOLUCIONES PARA DECORAR VENTANAS

SERIE PRESTIGE

Presentamos la colección "Prestige" en dos series:

- Romantic en colores clásicos
- Neons en colores vivos y alegres

*Colección bajo pedido

Estores

roman blinds / stores bateaux



Marvent

SOLUCIONES PARA DECORAR VENTANAS



barras de cortina · rieles · estores motorizados · paneles japoneses · accesorios · ollaos · cintas

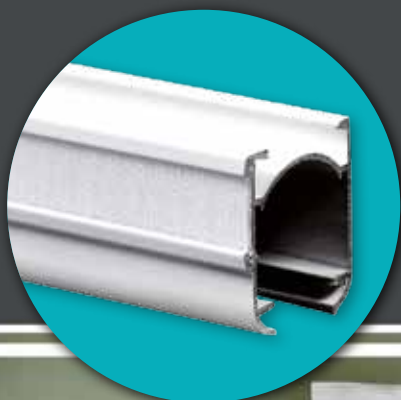

COMPACTO MARVENT ESTOR DE SISTEMA OCULTO

Producto

Estor

Mecanismo

Oculto

Sistema

Cadena

Material

Aluminio

Proceso

Lacado

Longitud

Máx.
600 cm

Color



- Fácil instalación
- Cordones extraíbles
- Facilita la extracción de la cortina

Te presentamos otro motivo para confiar en nosotros,
otra Novedad, otro buen Producto con el mejor Servicio.
Producto sólo para profesionales de la decoración.

Próximos Eventos Profesionales.

Si desea visitar alguna de estas ferias profesionales,
póngase en contacto con nosotros.



Estor Oculto (Manual) / NOT Visible Roman Blind (Manual) / Stores Bateaux NON Visible (Manuel)



Mecanismo estor oculto con cintas y pletina "NIZA"

	REF	Freno Lock Frein	Soportes Brackets Supports	Cilindros Cylinder Cylindre	U	€	€	cm
Estor Oculto "NIZA" NOT Visible Roman Blind "NIZA" / Stores Bateaux NON Visible "NIZA"	20607-YON100	1:1	2	2	6	30,95 €	35,60 €	100
	20607-YON125	1:1	3	3	6	36,88 €	42,42 €	125
Conjuntos Completos Montados Complete Assembled Sets / Kits CompletsMontés	20607-YON150	1:1	3	3	6	39,84 €	45,82 €	150
	20607-YON175	1:1	3	3	6	42,60 €	48,99 €	175
No incluye varillas / Laths not included / Sans jonc	20607-YON200	1:1	4	4	6	48,74 €	56,06 €	200
	20607-YON225	1:1	4	4	6	51,56 €	59,30 €	225
	20607-YON250	1:3	4	5	6	57,37 €	65,98 €	250

Mecanismo estor oculto con cintas, varillas y pletina "LYON"

	REF	Freno Lock Frein	Soportes Brackets Supports	Cilindros Cylinder Cylindre	U	€	€	cm
Estor Oculto "LYON" NOT Visible Roman Blind "LYON" / Stores Bateaux NON Visible "LYON"	20607-YOL100	1:1	2	2	6	32,36 €	37,22 €	100
	20607-YOL125	1:1	3	3	6	38,31 €	44,06 €	125
Conjuntos Completos Montados Complete Assembled Sets / Kits CompletsMontés	20607-YOL150	1:1	3	3	6	41,74 €	48,01 €	150
	20607-YOL175	1:1	3	3	6	45,35 €	52,16 €	175
No incluye varillas / Laths not included / Sans jonc	20607-YOL200	1:1	4	4	6	51,32 €	59,02 €	200
	20607-YOL225	1:1	4	4	6	54,93 €	63,17 €	225
	20607-YOL250	1:4	4	5	6	60,54 €	69,63 €	250

Mecanismo estor oculto con pletina "ÍNDALO"

	REF	Freno Lock Frein	Soportes Brackets Supports	Cilindros Cylinder Cylindre	U	€	€	cm
Estor Oculto "ÍNDALO" NOT Visible Roman Blind "ÍNDALO" / Stores Bateaux NON Visible "ÍNDALO"	20607-YOI100	1:1	2	2	6	28,16 €	32,38 €	100
	20607-YOI125	1:1	3	3	6	32,98 €	37,93 €	125
Conjuntos Completos Montados Complete Assembled Sets / Kits CompletsMontés	20607-YOI150	1:1	3	3	6	35,44 €	40,76 €	150
	20607-YOI175	1:1	3	3	6	38,00 €	43,70 €	175
No incluye varillas / Laths not included / Sans jonc	20607-YOI200	1:1	4	4	6	42,92 €	49,36 €	200
	20607-YOI225	1:1	4	4	6	45,48 €	52,30 €	225
	20607-YOI250	1:4	4	5	6	50,04 €	57,55 €	250

Nota: Los estores montados a medida tendrán un incremento del 30%. Todos los estores van con velcro incluido.

Accesorios / Accessories / Accessoires

Perfil

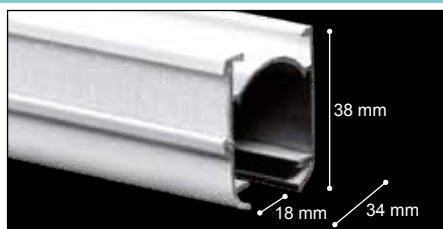

REF	∅				
20607-B600		60 m	7,80 €	8,97 €	

Freno con tapa



REF	∅				
20607-FR		50	6,00 €	6,90 €	

Freno reductor con tapa



REF	∅				
20607-FR14		50	6,00 €	6,90 €	

Cilindro cordón con hilo



REF	∅				
20607-PHC		50	3,40 €	3,91 €	

Soporte techo



REF	∅				
20607-T		50	0,80 €	0,92 €	

Soporte techo-frente



REF	∅				
20607-F		50	0,76 €	0,88 €	

* Soporte incluido en el kit / Bracket supplied in the kit / Support fourni dans le kit.

Soporte techo-frente



REF	∅				
20607-FC		50	0,88 €	1,02 €	

Bola de empalme



REF	∅				
20603-1518		100	0,70 €	0,81 €	

Codo estor



REF	∅				
20607-COA		50	22,68 €	26,08 €	

Accesorios / Accessories / Accessoires

Pletina blanca
25 cx 3

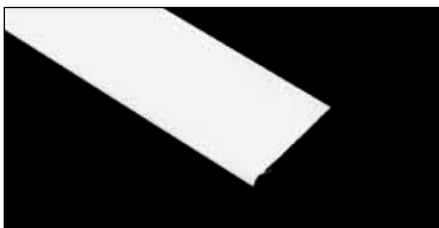

REF	∅				
20606-B12006		60 m	3,04 €/m	3,5 €/m	600
20607-TR255		40 m	6,52 €/m	7,50 €/m	400

Varilla de Fibra
4mm



REF	∅				
20606-4	4 mm	300 m	0,26 €		600

Eje de mando
de aluminio



REF	∅				
20650-3281	5 mm	60	2,20 €		600

Aro cadena
blanca



REF	∅				
20602-732		100	2,08 €	2,39 €	200
20602-7325		100	2,28 €	2,62 €	250
20602-733		100	2,40 €	2,76 €	300
20602-7335		100	2,68 €	3,09 €	350
20602-734		100	3,30 €	3,80 €	400

Aro cadena
metálica



REF	∅				
20602-CM100		25	4,00 €	4,60 €	2
20602-CM		25	5,00 €	5,75 €	3
20602-CM200		25	6,00 €	6,90 €	4

Anilla S plástico



REF	∅				
90606-G		1000	33,66 €/caja		

Anilla de plástico
9x13mm



REF	∅				
20603-D38		1000	33,64 €/caja		

Anilla de
lágrima

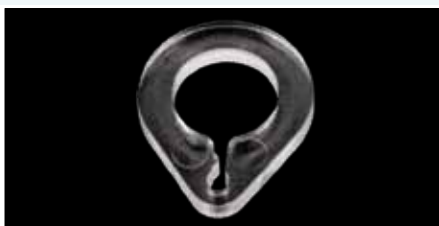

REF	∅				
20606-1138		1000	33,66 €/caja		

Protector de
Pletina



REF	∅				
20603-TP		500	0,19 €	0,22 €	

Accesorios / Accessories / Accessoires

Velcro hembra

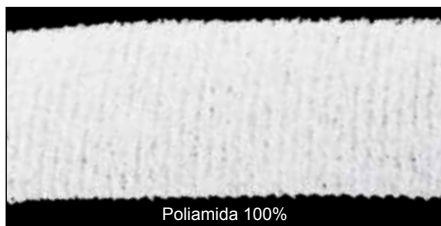

REF	COLOR	rollo (m) roll (m)	€	mm
30175-11001	blanco - rígido	50 m	0,40 €/m	20 mm
30175-22001	blanco - suave	50 m	0,44 €/m	20 mm
30175-24001	blanco - superpesado	50 m	0,52 €/m	20 mm

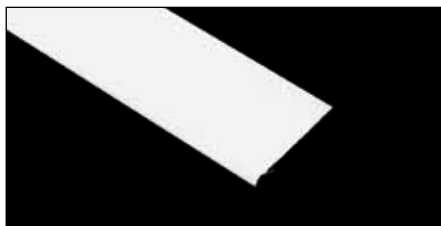
Cinta estor
Varilla

REF	COLOR	rollo (m) roll (m)	Precio (m)	mm
30178-0160B0CLA01300	blanco	300 m	0,32 €/m	16
30178-0160B0CLA02300	beige	300 m	0,34 €/m	16
30178-0160B0CLA03300	transpar.	300 m	0,40 €/m	16

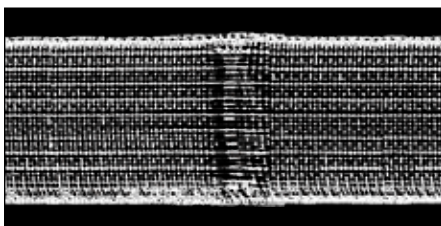
Cinta estor
austríaca
paso 5 cm

REF	COLOR	rollo (m) roll (m)	Precio (m)	mm
30178-B2000P5LA03300	transpar.	300 m	0,50 €/m	16

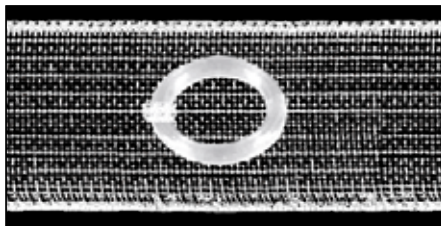
Cinta estor
austríaca
con anillas

REF	COLOR	rollo (m) roll (m)	Precio (m)	mm
30177-0161A0CLA03150	transpar.	150 m	0,50 €/m	16

Escuadras
blancas

REF	∅	U	€	€	cm
90609-B30		25	1,32 €	1,52 €	4
90609-B50		25	1,54 €	1,77 €	6
90609-B80		25	2,02 €	2,32 €	10
90609-B120		25	2,65 €	3,05 €	15
90609-B180		25	3,32 €	3,82 €	20

Escuadras
zincadas

REF	∅	U	€	€	cm
90609-40		25	1,24 €	1,49 €	4
90609-60		25	1,44 €	1,73 €	6
90609-80		25	1,76 €	2,11 €	10
90609-150		25	2,24 €	2,89 €	15

Escuadras
extrafuertes

REF	∅	U	€	€	cm
90609-B3001		25	3,36 €	3,86 €	7
90609-B3002		25	4,04 €	4,65 €	11
90609-B3003		25	4,80 €	5,52 €	15
90609-B3004		25	5,04 €	5,80 €	19
90609-B3005		25	5,24 €	6,03 €	23

Contrapeso
mini

REF	Color	U	€	€	cm
90977-1110BL	blanco	25	1,36 €/m	1,56 €	
90977-1110PL	plata	25	2,06 €/m	2,37 €	

Estor Oculto (Manual) / NOT Visible Roman Blind (Manual) / Stores Bateaux NON Visible (Manuel)

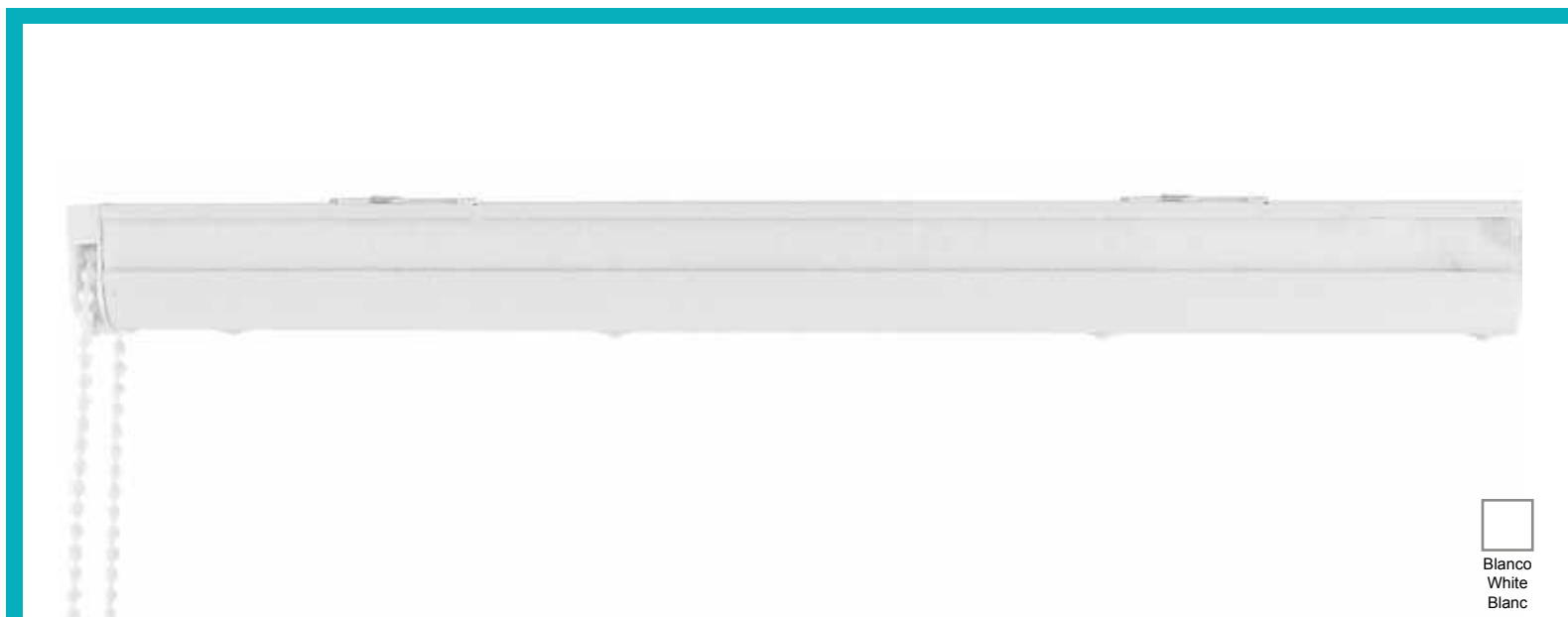

	REF	Freno Lock Frein	Soportes Brackets Supports	Guía Cordón Cord Guide Guides Cordón		€			
STARTRACK	D.11075	1:1	2	2	6	28,82 €	33,14 €	75	
Conjuntos Completos Montados /	D.11100	1:1	2	2	6	32,82 €	37,74 €	100	
Complete Assembled Sets /	D.11125	1:1	3	3	6	41,44 €	47,66 €	125	
Kits Complets Montés	D.11150	1:1	3	3	6	45,42 €	52,23 €	150	
	D.11175	1:1	3	3	6	49,42 €	56,83 €	175	
	D.11200	1:1	4	4	6	57,62 €	66,26 €	200	
* No incluye varillas/ * Laths not included/ * Sans jonc	D.11250	1:3	5	5	6	70,84 €	81,47 €	250	
	D.11300	1:3	5	6	6	85,62 €	98,46 €	300	
	D.11350	1:3	6	7	6	96,06 €	110,47 €	350	
	D.11400	1:3	6	8	6	108,68 €	124,98 €	400	

Información General / General Information / Informations Générales

Riel de aluminio lacado en blanco con mecanismo integrado y sistema de elevación de cadeneta estores.

Freno 1:1 hasta 6 kg.

Freno 1:3 hasta 15 kg.

El conjunto completo consiste en:

- Perfil velcroado.
- Mecanismo integrado: (Guía-hilos, freno, cadeneta 3m., varilla y tapa).
- Soportes ref. D.1015 (se puede cambiar por D.1023, solicitándolo en el pedido).
- Pletina contrapeso ref: C.12003BL.
- Cordón 4 m.

White lacquered aluminium track with integrated mechanism and chain operated for roman blinds.

Lock 1:1 Up to 6 kg.

Lock 1:3 Up to 15 kg.

Complete set consists of:

- Velcro-bonded profile.
- Integrated mechanism: (Cord Guides, 3m chainlock, shaft, encap).
- Brackets ref. D.1015 (Supplied also with bracket D.1023 upon request).
- Batten ref: C.12003BL.
- Cord 4 m.

Rail aluminium blanc laqué avec système mecanisme intégré et chaîne pour store Romain.

Frein 1:1 Jusqu'à 6 kg.

Frein 1:3 Jusqu'à 15 kg.

Le kit complet est composé de:

- Rail velcro.
- Le système intégré: (Guide Cordón, freno, chaînette 3m).
- Supports ref. D.1015 (Fourni avec le support D.1023 sur demande).
- Barre de lestage ref: C.12003BL.
- Corde 4 m.

Accesorios / Accessories / Accessoires

Riel Velcroado

Aluminium Track with Velcro / Rail Aluminium avec Velcro

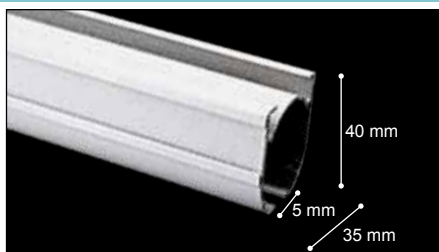

REF		€		
D.1011	60	10,42 €	11,98 €	600

Accesorios / Accessories / Accessoires

Freno 1:1
(sin cadena)Chain Locking
Mechanism 1:1
(without chain) /
Mecanisme Blocage
de Chaîne 1:1
(sans chainette)

REF	∅				
D.1012		25	4,66 €	5,36 €	

Freno 1:3
(sin cadena)Chain Locking
Mechanism 1:3
(without chain) /
Mecanisme Blocage
de Chaîne 1:3
(sans chainette)

REF	∅				
D.1013		25	4,66 €	5,36 €	

Rodillo Guía-Hilos
4m Cordón (1,2mm)Cord Barrel Guide 4m
cord (1,2mm) /
Rouleau Guide Fil
4m corde (1,2mm)

REF	∅				
D.1014		25	4,22 €	4,85 €	

Rodillo Guía-Hilos
(sin cordón)Cord Barrel Guide
(without cord) /
Rouleau Guide Fil
(sans cordon)

REF	∅				
D.1014S		25	3,06 €	3,52 €	

Soporte

Bracket /
Support

REF	∅				
D.1015		50	0,66 €	0,76 €	

* Soporte incluido en el kit / Bracket supplied in the kit / Support fourni dans le kit.

Soporte con Muelle

Spring Barcket /
Support à Ressort

REF	∅				
D.1017		50	0,72 €	0,83 €	

Tapa



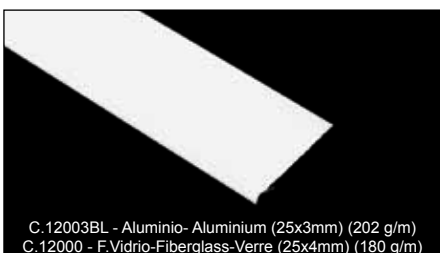

Endcap /
Bouchon Final

REF	∅				
D.1016		50	0,70 €	0,81 €	

Pletinas
ContrapesoBattens For
Track Blinds /
Contrepoids Pour
Stores RomainC.12003BL - Aluminio- Aluminium (25x3mm) (202 g/m)
C.12000 - F.Vidrio-Fiberglass-Verre (25x4mm) (180 g/m)

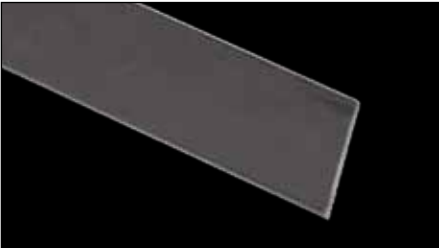
REF	∅				
20606-B12006		60	3,04 €/m	3,50 €/m	600

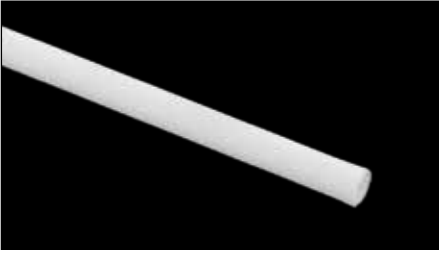
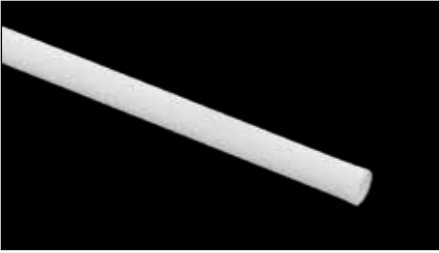
Accesorios / Accessories / Accessoires

<p>Pletinas Contrapeso Metacrilato Transp. (27x5mm)</p>		<table border="1"> <thead> <tr> <th>REF</th> <th>∅</th> <th>U</th> <th>€</th> <th>€</th> <th>cm</th> </tr> </thead> <tbody> <tr> <td>20607-TR255</td> <td></td> <td>40</td> <td>6,52 €/m</td> <td>7,50 €/m</td> <td>400</td> </tr> </tbody> </table>	REF	∅	U	€	€	cm	20607-TR255		40	6,52 €/m	7,50 €/m	400
REF	∅	U	€	€	cm									
20607-TR255		40	6,52 €/m	7,50 €/m	400									
<p>Transparent Acrylic Batten (27x5mm) / Contrepoid Metacrylate Transparente (27x5mm)</p>														
<p>Protector de Pletina 3x25</p> <p>Protective Batten 3x25 / Protecteur de Contrepoids 3x25</p>		<table border="1"> <thead> <tr> <th>REF</th> <th>∅</th> <th>U</th> <th>€</th> <th>€</th> <th>cm</th> </tr> </thead> <tbody> <tr> <td>20603-TP</td> <td></td> <td>500</td> <td>0,194 €</td> <td>0,223 €</td> <td></td> </tr> </tbody> </table>	REF	∅	U	€	€	cm	20603-TP		500	0,194 €	0,223 €	
REF	∅	U	€	€	cm									
20603-TP		500	0,194 €	0,223 €										
<p>Perfil Contrapeso redondo Blanco (14mm)</p> <p>White round cordweight profile / Rail contrepoids rond blanc</p>		<table border="1"> <thead> <tr> <th>REF</th> <th>∅</th> <th>U</th> <th>€</th> <th>€</th> <th>cm</th> </tr> </thead> <tbody> <tr> <td>C.12024BL</td> <td>14 mm</td> <td>60</td> <td>4,32 €/m</td> <td>4,97 €/m</td> <td>600</td> </tr> </tbody> </table>	REF	∅	U	€	€	cm	C.12024BL	14 mm	60	4,32 €/m	4,97 €/m	600
REF	∅	U	€	€	cm									
C.12024BL	14 mm	60	4,32 €/m	4,97 €/m	600									
<p>Protector Tapón para perfil contrapeso redondo (C.12024BL)</p> <p>Protective endcap for round cordweight profile / Embout protecteur pour rail contrepoids rond</p>		<table border="1"> <thead> <tr> <th>REF</th> <th>∅</th> <th>U</th> <th>€</th> <th>€</th> <th>cm</th> </tr> </thead> <tbody> <tr> <td>D.312</td> <td>14</td> <td>500</td> <td></td> <td>0,19 €</td> <td></td> </tr> </tbody> </table>	REF	∅	U	€	€	cm	D.312	14	500		0,19 €	
REF	∅	U	€	€	cm									
D.312	14	500		0,19 €										
<p>Varilla de Fibra de Vidrio (4mm)</p> <p>Fiberglass Lath / Jonc Fibre de Verre pour Stores Romain Trans (27x5mm.)</p>		<table border="1"> <thead> <tr> <th>REF</th> <th>∅</th> <th>U</th> <th>€</th> <th>€</th> <th>cm</th> </tr> </thead> <tbody> <tr> <td>20606-4</td> <td>4 mm</td> <td>600</td> <td>0,26 €/m</td> <td></td> <td>600</td> </tr> </tbody> </table>	REF	∅	U	€	€	cm	20606-4	4 mm	600	0,26 €/m		600
REF	∅	U	€	€	cm									
20606-4	4 mm	600	0,26 €/m		600									
<p>Varilla de Fibra de Vidrio (3mm)</p> <p>Fiberglass Lath / Jonc Fibre de Verre pour Stores Romain</p>		<table border="1"> <thead> <tr> <th>REF</th> <th>∅</th> <th>U</th> <th>€</th> <th>€</th> <th>cm</th> </tr> </thead> <tbody> <tr> <td>D.3600</td> <td>3 mm</td> <td>900</td> <td>0,33 €/m</td> <td>0,38 €/m</td> <td>600</td> </tr> </tbody> </table>	REF	∅	U	€	€	cm	D.3600	3 mm	900	0,33 €/m	0,38 €/m	600
REF	∅	U	€	€	cm									
D.3600	3 mm	900	0,33 €/m	0,38 €/m	600									
<p>Eje de mando de Aluminio</p> <p>Aluminium Shaft / Jonc Aluminium</p>		<table border="1"> <thead> <tr> <th>REF</th> <th>∅</th> <th>U</th> <th>€</th> <th>€</th> <th>cm</th> </tr> </thead> <tbody> <tr> <td>20650-3281</td> <td>4 mm</td> <td>60</td> <td>2,20 €/m</td> <td>2,64 €/m</td> <td>6</td> </tr> </tbody> </table>	REF	∅	U	€	€	cm	20650-3281	4 mm	60	2,20 €/m	2,64 €/m	6
REF	∅	U	€	€	cm									
20650-3281	4 mm	60	2,20 €/m	2,64 €/m	6									
<p>Soporte Techo Soporte plano</p> <p>Ceiling Plain Bracket / Support plafond</p>		<table border="1"> <thead> <tr> <th>REF</th> <th>∅</th> <th>U</th> <th>€</th> <th>€</th> <th>cm</th> </tr> </thead> <tbody> <tr> <td>20607-T</td> <td></td> <td>50</td> <td>0,80 €</td> <td>0,92 €</td> <td></td> </tr> </tbody> </table>	REF	∅	U	€	€	cm	20607-T		50	0,80 €	0,92 €	
REF	∅	U	€	€	cm									
20607-T		50	0,80 €	0,92 €										

Accesorios / Accessories / Accessoires

Codo estor

Roman Blind Joint /
Coude Store Bateaux

REF	∅				
20607-COA		50	22,68 €	26,08 €	

Cordón (Bobina) 1,5
mmCord (Spool) 1,5 mm /
Corde 1,5 mm

REF	∅				
20603-CO	1,5 mm	500 m	0,08 €	0,10 €	

Rollo Cadeneta

Chain Roll /
Rouleau

REF	∅				
D.74		200 m	1,36 €/m	1,63 €/m	
D.74PL		150 m	1,36 €/m	1,63 €/m	

Cadeneta Sin Fin

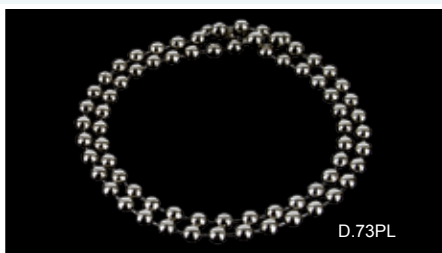
Continuous Chain /
Chainette

REF	∅				
20602-CM100		25	4,00 €	4,60 €	2
20602-CM		25	5,00 €	5,75 €	3
20602-CM200		25	6,00 €	6,90 €	4

Contrapeso
Mini Blanco
(43 g aprox.)Mini-cordweight
White /
Mini-contrepoids Blanc

REF	∅				
90977-1110BL		25	1,36 €	1,56 €	

Contrapeso
Mini Plata
(43 g aprox.)Mini-cordweight
Nickel /
Mini-contrepoids
Plaqué

REF	∅				
90977-1110PL		25	2,06 €	2,37 €	

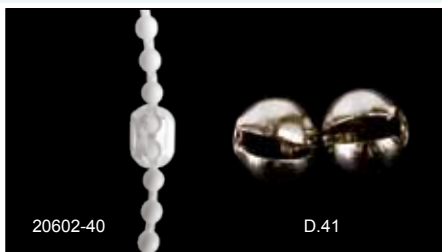
Empalme
CadenetaChain Splice /
Raccord de
Chainette

REF	∅				
20602-40		200	0,20 €	0,23 €	
D.41		500	1,74 €	2,09 €	

Anilla de Plástico

Plastic Rings /
Anneau Plastique

REF	∅				
90606-G		1000	33,66 €		

Accesorios / Accessories / Accessoires

Anilla de Plástico
(9x13mm)

Plastic Rings
(9x13mm) /
Anneau Plastique
(9x13mm)



REF	∅	U	€	€	cm
20603-D38		1000	36,64 €		

Anilla de Plástico

Plastic Rings /
Anneau Plastique



REF	∅	U	€	€	cm
20606-1138		1000	33,66 €		

Cinta para Varilla
Estor (16mm)

Roman Blind
LathTape /
Ruban pour Barre
de Store Romain

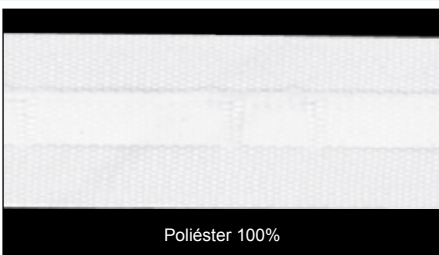

REF	COLOR	U	€	€	mm
30178-0160B0CLA01300	blanco	300 m	0,32 €/m		16
30178-0160B0CLA02300	beige	300 m	0,34 €/m		16
30178-0160B0CLA03300	transparente	300 m	0,40 €/m		16

Cinta Cierre-Velcro
Hembra 20mm.

20 mm Touch&close
fastener Tape
(Loop section) /
Velcro femelle
20mm.

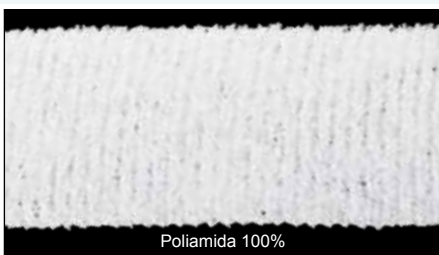

REF	COLOR	U	€	€	mm
30175-11001	blanco	50 m	0,40 €/m		20
30175-22001	blanco	50 m	0,44 €/m		20
30175-24001	blanco	50 m	0,52 €/m		20

Soporte Múltiple
de Pared Blanco

White Wall
Extension Bracket /
Support Mural
Blanc



REF	∅	U	€	€	cm
90609-B30		25	1,32 €	1,52 €	4
90609-B50		25	1,54 €	1,77 €	6
90609-B80		25	2,02 €	2,32 €	10
90609-B120		25	2,65€	3,05 €	15
90609-B180		25	3,32 €	3,82 €	20

Soporte Múltiple de
Pared Extrafuerte

Wall Extension
Bracket
(Extrastrong) /
Support Mural
Extrafort



REF	∅	U	€	€	cm
90609-B3001		25	3,36 €	3,86 €	7
90609-B3002		25	4,04 €	4,65 €	11
90609-B3003		25	4,80 €	5,52 €	15
90609-B3004		25	5,04 €	5,80 €	19
90609-B3005		25	5,24 €	6,03 €	23

Muestra estor
STARTRACK

Demo sample
Startrack
roman blind /
Echantillon stores
bateaux Startrack



REF	∅	U	€	€	cm
M.305		1		12,86 €	

STARTRACK (Motorizado) / STARTRACK (Motorized system) / STARTRACK (avec Motor)



EASY COMPACT (Motorizado) / EASY COMPACT (Motorized system) / EASY COMPACT (avec Motor)



2 Opciones de Motorización:

- Kit Motorización **DC** Completo Incluye:
Motor y Transformador
- Kit Motorización **Batería** Externa Completo Incluye:
Motor y Carcasa para batería y Soportes.

Características Técnicas Motor

- El Receptor está integrado en el motor.
- Funciona por radiofrecuencia, con mando a distancia de 15 canales con un alcance de 35 m.
- La programación del sistema es muy fácil y rápida.
- Ancho mínimo del riel: 500 mm.
- Largo máximo del riel: 3 metros.
- Área máxima de arrastre 8m2.
- Final de carrera electrónico con receptor integrado.
- Protección contra sobrecargas eléctricas.
- Parada automática al finalizar su recorrido.
- Peso máximo soportado 4 Kg (peso total de la cortina).
- No permite conexión Domótica.
- MARVENT ofrece una **Garantía de 2 años** para todos sus

Motores, a partir de la fecha de factura, salvo mal uso o rotura por parte del cliente-usuario-instalador.



Esquema de conexión DC
Scheme DC connection / Schéma de branchement DC:



Esquema de conexión Batería Externa
Scheme External Battery connection / Schéma de branchement batterie externe:

2 Motorized Options:

- Motorized **DC** kit including: motor and adaptor.
- Motorized Kit with **External Battery** including:
motor, battery housing, and brackets.

Motor Technical Features

- Built-in receiver.
- Radiofrequency works with a 15channel remote control (35m operative range).
- Fast and easy programming.
- Minimum blind width: 500 mm.
- Maximum blind length: 3 meters.
- Load maximum allowable area: 8 m2
- Electronic end limit with built-in receiver
- Electrical overload protection feature.
- Motor switches off automatically when limits are reached.
- Maximum blind weight: 4 kg.
- Home Automation System is not applicable.
- MARVENT offers a **2 year warranty** for all motors, from the date of invoice, unless misuse or failure by the customer-user-installer.

2 Options de Systèmes de Motorisation:

- Kit **DC** motorisé en incluant: moteur et transformateur.
- Kit motorisé avec **Batterie Externe** en incluant:
moteur, logement batterie et supports.



Caractéristique Technique Moteur

- Récepteur intégré dans le moteur
- Fonctionne pour radiofréquences avec télécommande de 15 canaux avec une portée de 35m.
- La programmation est très simple et rapide.
- Largeur minimum du rail: 500 mm.
- Longueur maximum du rail: 3 mètres.
- Domaine de poussée maximum 8m2.
- Fin de course électronique avec récepteur intégré.
- Protection contre les surcharges électriques.
- Arrêt automatique à la fin du parcours.
- Poids maximum supporté: 4 kg (poids total du rideau).
- Ne permet pas Système Domotique.
- MARVENT offre une **garantie de 2 ans** pour tous les moteurs, à partir de la date de la facture, sauf utilisation incorrecte ou non par le client-utilisateur-installateur.

EASY COMPACT & STARTRACK: Kit Motorización / Motorized Kit / Kit Motorisé

STARTRACK y EASY COMPACT MOTOR	REF	Motor Motor Moteur D.1018	Acoples Adaptor Transformateur D.1040	Soporte Motor Bracket Motor Moteur Support			
	D.1005 - Kit Motorización DC Motorized Kit DC Kit Motorisé DC	D.1005	1	1	1	1	181,52 €
D.1006 - Kit Motorización Batería Externa Motorized Kit External Battery Kit Motorisé Batterie Externe	D.1006	1	1	1	1	181,52 €	

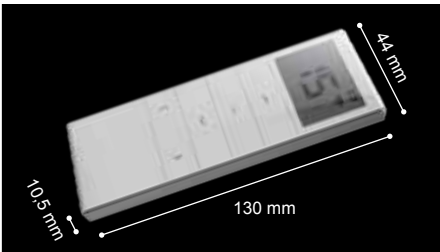
Accesorios Startrack y Easy Compact / Startrack and Easy Compact Accessories / Accessoires Startrack et Easy Compact

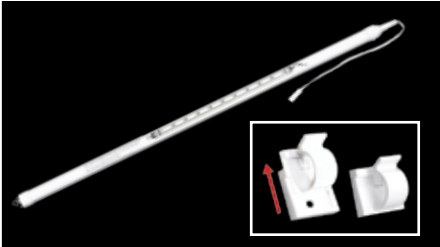
<p>Motor 12V DC 0,8Nm, 10W, 0,83A, 45rpm, 0,212 kg</p> <p>Motor / Moteur</p> 	<table border="1"> <thead> <tr> <th>REF</th> <th></th> <th></th> <th></th> <th></th> <th></th> </tr> </thead> <tbody> <tr> <td>D.1018</td> <td></td> <td>1</td> <td></td> <td>145,52 €</td> <td></td> </tr> </tbody> </table>	REF						D.1018		1		145,52 €	
REF													
D.1018		1		145,52 €									
<p>Mando a Distancia LED 15 canales</p> <p>Remote Control LED 15 channels / Télécommande LED 15 canaux</p> 	<table border="1"> <thead> <tr> <th>REF</th> <th></th> <th></th> <th></th> <th></th> <th></th> </tr> </thead> <tbody> <tr> <td>D.1041</td> <td></td> <td>1</td> <td></td> <td>51,74 €</td> <td></td> </tr> </tbody> </table>	REF						D.1041		1		51,74 €	
REF													
D.1041		1		51,74 €									
<p>Transformador</p> <p>Adaptor / Transformateur</p> 	<table border="1"> <thead> <tr> <th>REF</th> <th></th> <th></th> <th></th> <th></th> <th></th> </tr> </thead> <tbody> <tr> <td>D.1040</td> <td></td> <td>1</td> <td></td> <td>36,00 €</td> <td></td> </tr> </tbody> </table>	REF						D.1040		1		36,00 €	
REF													
D.1040		1		36,00 €									
<p>Carcasa para Pilas (Kit Batería)</p> <p>External battery housing / Logement externe batterie</p> 	<table border="1"> <thead> <tr> <th>REF</th> <th></th> <th></th> <th></th> <th></th> <th></th> </tr> </thead> <tbody> <tr> <td>D.1046</td> <td></td> <td>1</td> <td></td> <td>36,00 €</td> <td></td> </tr> </tbody> </table>	REF						D.1046		1		36,00 €	
REF													
D.1046		1		36,00 €									

Características Batería Externa:
Funciona con 10 pilas AA (pilas no incluidas).

Test de funcionamiento de la Batería Externa:

- Tramo recorrido: 1,6 m.
- Peso arrastrado: 4 kg.
- Nº de repeticiones del movimiento: 230 ciclos.

Technical Features of External Battery:
Powered by 10 AA batteries (not included)

Running test of external battery:

- Distance measured: 1,6m.
- Carried weight: 4 kgs.
- Number of repetitions of the movement: 230 cycles.

Caractéristique Technique Batterie Externe:
Fonctionnant sur 10 piles AA (non incluses)

Test de fonctionnement de la batterie externe:

- Section du parcours: 1.6M
- Poids des charge traînées: 4 kgs.
- Nombre de répétitions du mouvement: 230 cycles

CORTINAS TÉCNICAS

Protección solar creando zonas cálidas y confortables, embelleciendo el ambiente y dándole un toque personal a su casa.

Ponemos a su disposición catálogos y tarifas de precios de todos los productos.



Enrollables



Noche y Día



Impresión digital



Enrollables para puertas y ventanas



Verticales



Venecianas de madera



Venecianas de aluminio



Verticales de madera

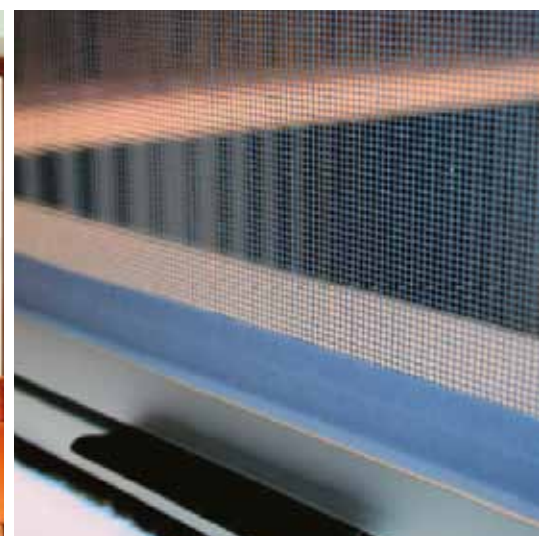

Mosquiteras

Estor Oculto (Manual) / NOT Visible Roman Blind (Manual) / Stores Bateaux NON Visible (Manuel)



Mecanismo estor cadena con cintas y pletina "CAPRI"

Estor cadeneta "CAPRI"	REF	Soportes Brackets Supports	Guía galón	U	€	€	cm
	20602-YCC100	2	2	6	26,45 €	30,41 €	100
20602-YCC125	2	2	6	29,08 €	33,44 €	125	
20602-YCC150	3	3	6	36,48 €	41,95 €	150	
20602-YCC175	3	3	6	38,16 €	43,88 €	175	
20602-YCC200	4	3	6	40,26 €	46,30 €	200	
20602-YCC225	4	3	6	42,36 €	48,71 €	225	

Mecanismo estor cadena con cintas, varillas y pletina "ROMA"

Estor cadeneta "ROMA"	REF	Soportes Brackets Supports	Guía galón	U	€	€	cm
	20602-YMC100	2	2	6	27,91 €	32,09 €	100
20602-YMC125	2	2	6	31,63 €	36,38 €	125	
20602-YMC150	3	3	6	38,67 €	44,47 €	150	
20602-YMC175	3	3	6	41,36 €	47,57 €	175	
20602-YMC200	4	3	6	44,48 €	51,16 €	200	
20602-YMC225	4	3	6	47,59 €	54,73 €	225	

Mecanismo estor cadena con pletina "SICILIA"

Estor cadeneta "SICILIA"	REF	Soportes Brackets Supports	Guía galón	U	€	€	cm
	20602-YSC100	2	2	6	23,94 €	27,53 €	100
20602-YSC125	2	2	6	26,68 €	30,68 €	125	
20602-YSC150	3	3	6	32,65 €	37,55 €	150	
20602-YSC175	3	3	6	33,19 €	38,16 €	175	
20602-YSC200	4	3	6	36,34 €	41,79 €	200	
20602-YSC225	4	3	6	38,28 €	44,02 €	225	

Nota: Los estores montados a medida tendrán un incremento del 30%. Todos los estores van con velcro incluido.

Accesorios / Accessories / Accessoires

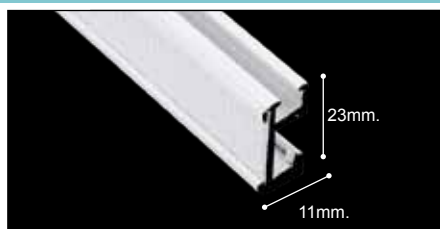
Perfil de aluminio
velcroado

REF	∅	U	€	€	cm
20603-B600		60 m	3,30 €/m	3,80 €/m	600

Freno cadeneta



REF	Paso	U	€	€	cm
20602-77	1:1	50	3,34 €	3,85 €	
20602-76	1:5	50	3,34 €	3,85 €	

Guía galón
montada

REF	Paso	U	€	€	cm
20602-79MT	transpar.	50	3,62 €	4,17 €	
20602-79M	blanco	50	3,42 €	3,94 €	

Guía galón



REF	∅	U	€	€	cm
20602-79		50	2,58 €	2,97 €	

Soporte
universal

REF	∅	U	€	€	cm
20603-S		50	0,27 €	0,31 €	3

Soporte
frente-techo 4 cm

REF	∅	U	€	€	cm
20603-S4		50	0,60 €	0,62 €	4

Soporte
frente-techo 7 cm

REF	∅	U	€	€	cm
20603-S7		50	0,94 €	0,99 €	7

Soporte
de techo
articulado 3 cm

REF	∅	U	€	€	cm
20603-SA3		50	0,36 €	0,41 €	3

Soporte
frente-techo
articulado 4 cm

REF	∅	U	€	€	cm
20603-SA4		50	0,42 €	0,48 €	

Accesorios / Accessories / Accessoires

Soporte
frente-techo
articulado 7 cm



REF	∅	U	€	€	cm
20603-SA6		50	0,55 €	0,64 €	

Tapa estor



REF	∅	U	€	€	cm
20603-T		100	0,19 €	0,22 €	

Clip de galón



REF	∅	U	€	€	cm
20602-43		100	0,66 €	0,76 €	

Corredera de Plástico

Plastic glider /
Glisseur Plastique



REF	∅	U	€	€	cm
20602-999		1000	0,07 €	0,08 €	

Codo/empalme
angular



REF	∅	U	€	€	cm
20603-CO		50	1,46 €	1,75 €	

Empalme
cadena



REF	∅	U	€	€	cm
20602-40		200	0,20 €	0,23 €	

Pletina blanca
25 cx 3

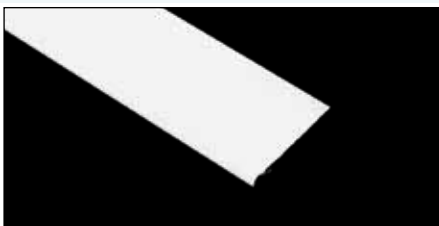

REF	Color	U	€	€	cm
20606-B12006	blanco	60 m	3,04 €/m	3,5 €/m	600
20607-TR255	transp.	40 m	6,52 €/m	7,50 €/m	400

Varilla de Fibra
4mm



REF	∅	U	€	€	cm
20606-4	4 mm	300 m	0,26 €		600

Eje de mando
de aluminio



REF	∅	U	€	€	cm
20650-3281	5 mm	60 m	2,20 €/m		600

Accesorios / Accessories / Accessoires

Aro cadena
blanca

REF	∅	U	€	€	cm
20602-732		100	2,08 €	2,39 €	200
20602-7325		100	2,28 €	2,62 €	250
20602-733		100	2,40 €	2,76 €	300
20602-7335		100	2,68 €	3,09 €	350
20602-734		100	3,30 €	3,80 €	400

Aro cadena
metálica

REF	∅	U	€	€	cm
20602-CM100		25	4,00 €	4,60 €	2
20602-CM		25	5,00 €	5,75 €	3
20602-CM200		25	6,00 €	6,90 €	4

Anilla S plástico



REF	∅	U	€	€	cm
90606-G		1000	33,66 €/caja		

Anilla de plástico
9x13mm

REF	∅	U	€	€	cm
20603-D38		1000	33,64 €/caja		

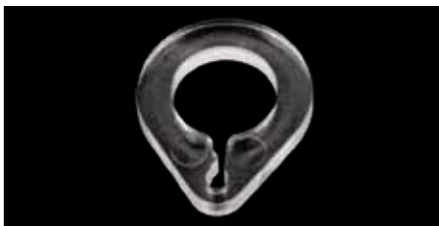
Anilla de
lágrima

REF	∅	U	€	€	cm
20606-1138		1000	33,66 €/caja		

Protector de
Pletina

REF	∅	U	€	€	cm
20603-TP		500	0,19 €	0,22 €	

Velcro hembra

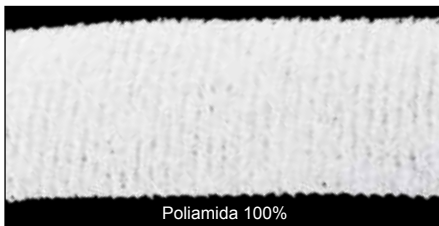

REF	COLOR	rollo (m) roll (m)	€	mm
30175-11001	blanco - rígido	50 m	0,40 €/m	20 mm
30175-22001	blanco - suave	50 m	0,44 €/m	20 mm
30175-24001	blanco - superpesado	50 m	0,52 €/m	20 mm

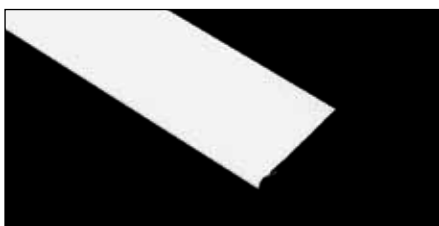
Cinta estor
Varilla

REF	COLOR	rollo (m) roll (m)	Precio (m)	mm
30178-0160B0CLA01300	blanco	300 m	0,32 €/m	16
30178-0160B0CLA02300	beige	300 m	0,34 €/m	16
30178-0160B0CLA03300	transpar.	300 m	0,40 €/m	16

Accesorios / Accessories / Accessoires

Cinta estor
austríaca
paso 5 cm

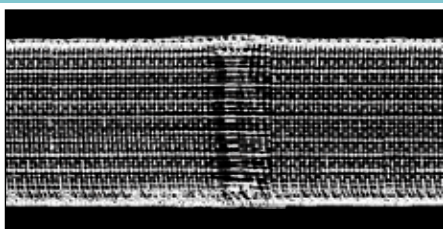

REF	COLOR	rollo (m) roll (m)	Precio (m)	
30178-B2000P5LA03300	transpar.	300 m	0,50 €/m	16

Cinta estor
austríaca c/anillas

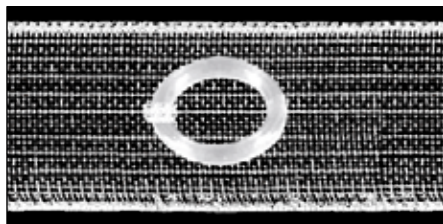

REF	COLOR	rollo (m) roll (m)	Precio (m)	
30177-0161A0CLA03150	transpar.	150 m	0,50 €/m	16

Escuadras
blancas



REF					
90609-B30		25	1,32 €	1,52 €	4
90609-B50		25	1,54 €	1,77 €	6
90609-B80		25	2,02 €	2,32 €	10
90609-B120		25	2,65 €	3,05 €	15
90609-B180		25	3,32 €	3,82 €	20

Escuadras
zincadas



REF					
90609-40		25	1,24 €	1,49 €	4
90609-60		25	1,44 €	1,73 €	6
90609-80		25	1,76 €	2,11 €	10
90609-150		25	2,24 €	2,89 €	15

Escuadras
extrafuertes



REF					
90609-B3001		25	3,36 €	3,86 €	7
90609-B3002		25	4,04 €	4,65 €	11
90609-B3003		25	4,80 €	5,52 €	15
90609-B3004		25	5,04 €	5,80 €	19
90609-B3005		25	5,24 €	6,03 €	23

Contrapeso
mini



REF					
90977-1110BL		25	1,36 €/m	1,56 €	
90977-1110PL		25	2,06 €/m	2,37 €	

Clip bloqueo
cinta (para coser)



REF					
20603-B40943		100	0,34 €	0,41 €	

Bola de
empalme







REF					
20603-1518		100	0,70 €	0,81 €	

Estor a cordón (Accionamiento Cordón) / Roman blind (cord - drawn) / Store bateau (tirage á cordon)





Blanco
White
Blanc





Mecanismo estor a cordón con cintas, cordón y pletina "VOLGA"

Estor a cordón "VOLGA"	REF	Soportes Brackets Supports	Pasahilos				
	20603-YVB100	2	3	6	16,23 €	18,66 €	100
20603-YVB125	3	3	6	18,48 €	21,25 €	125	
20603-YVB150	3	3	6	20,40 €	23,46 €	150	
20603-YVB175	3	3	6	22,48 €	25,85 €	175	
20603-YVB200	4	4	6	25,45 €	29,27 €	200	

Mecanismo estor cadena con cintas, varillas cordón y pletina "ELBA"

Estor a cordón "ELBA"	REF	Soportes Brackets Supports	Pasahilos				
	20603-YEB100	2	3	6	17,26 €	20,42 €	100
20603-YEB125	3	3	6	20,61 €	23,70 €	125	
20603-YEB150	3	3	6	23,07 €	26,53 €	150	
20603-YEB175	3	3	6	25,82 €	29,69 €	175	
20603-YEB200	4	4	6	28,75 €	33,06 €	200	

Mecanismo estor cadena con pletina "SENA"

Estor a cordón "SENA"	REF	Soportes Brackets Supports	Pasahilos				
	20603-YSS100	2	3	6	13,38 €	15,39 €	100
20603-YSS125	3	3	6	15,63 €	17,97 €	125	
20603-YSS150	3	3	6	17,25 €	19,84 €	150	
20603-YSS175	3	3	6	18,88 €	21,71 €	175	
20603-YSS200	4	4	6	21,45 €	24,67 €	200	

Nota: Los estores montados a medida tendrán un incremento del 30%. Todos los estores van con velcro incluido.

Estor con soporte BOTÓN (Cordón) / Roman blind with BUTTON bracket / Store bateau avec support BOUTON



TROYA BOTÓN Cordón Conjuntos completos CON VARILLAS / Complete sets WITH LATHS / Kits complets AVEC JONCS * Cintas de confección no incluidas / * Curtain Tapes not included / * Rubans de Rideau non inclus	REF	Soportes Brackets Supports	Correderas Gliders Glisseur					
	D.960	2	2	10	23,58 €	27,12 €	75	210
D.961	2	2	10	26,48 €	30,45 €	100	210	
D.962	3	3	10	32,44 €	37,31 €	125	210	
D.963	3	3	10	36,20 €	41,63 €	150	210	

TROYA BOTÓN Cordón Conjuntos completos SIN VARILLAS / Complete sets WITHOUT LATHS / Kits complets SANS JONCS * Cintas de confección no incluidas / * Curtain Tapes not included / * Rubans de Rideau non inclus	REF	Soportes Brackets Supports	Correderas Gliders Glisseur					
	D.970	2	2	10	19,88 €	22,86 €	75	210
D.971	2	2	10	22,68 €	26,08 €	100	210	
D.972	3	3	10	27,70 €	31,86 €	125	210	
D.973	3	3	10	32,32 €	37,17 €	150	210	

Estor Troya ADHESIVO (Accionamiento Cordón) / ADHESIVE roman blind / ADHESIF store bateau

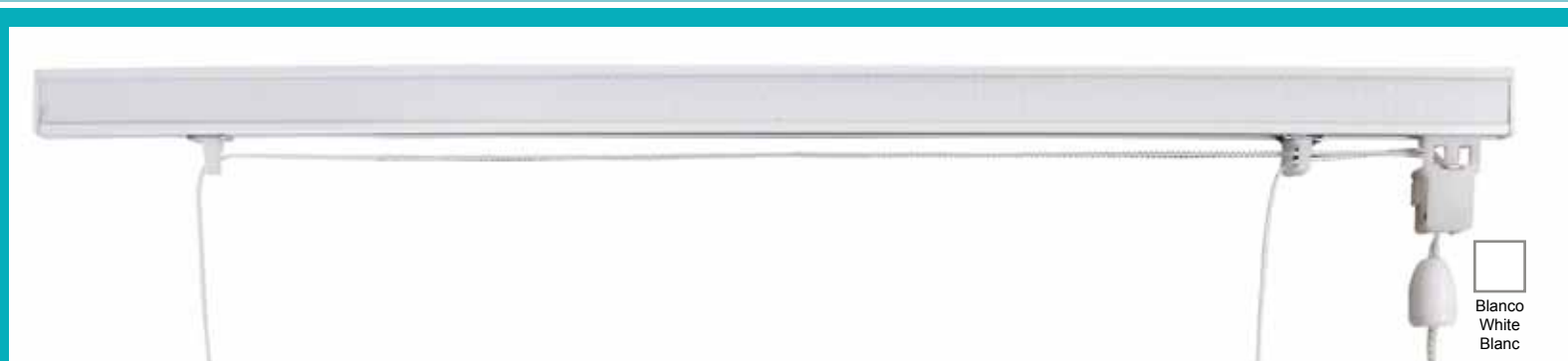

TROYA ADHESIVO Cordón Conjuntos completos CON VARILLAS / Complete sets WITH LATHS / Kits complets AVEC JONCS * Cintas de confección no incluidas / * Curtain Tapes not included / * Rubans de Rideau non inclus	REF	Soportes Brackets Supports	Correderas Gliders Glisseur					
	D.3075	2	2	10	21,94 €	25,23 €	75	210
D.3100	2	2	10	26,50 €	30,48 €	100	210	

TROYA ADHESIVO Cordón Conjuntos completos SIN VARILLAS / Complete sets WITHOUT LATHS / Kits complets SANS JONCS * Cintas de confección no incluidas / * Curtain Tapes not included / * Rubans de Rideau non inclus	REF	Soportes Brackets Supports	Correderas Gliders Glisseur					
	D.2075	2	2	10	19,66 €	22,61 €	75	210
D.2100	2	2	10	23,48 €	27,00 €	100	210	

Accesorios MARVENT / TROYA

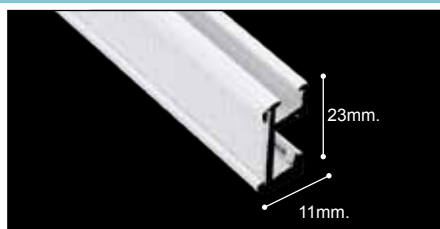
Perfil de aluminio
velcroado

REF	∅	U	€	1 €	cm
20603-B600		60 m	3,30 €/m	3,80 €/m	600

Perfil de aluminio
velcroado

REF	∅	U	€	1 €	cm
C.12008BL		60 m	6,42 €/m	7,38 €/m	600

Tapa estor



REF	∅	U	€	1 €	cm
20603-T		100	0,19 €	0,22 €	

Freno



REF	∅	U	€	1 €	cm
20603-FR		50	0,72 €	0,83 €	

Soporte
universal

REF	∅	U	€	1 €	cm
20603-S		50	0,27 €	0,31 €	3

Soporte
frente-techo 4 cm

REF	∅	U	€	1 €	cm
20603-S4		50	0,60 €	0,62 €	4

Soporte
frente-techo 7 cm

REF	∅	U	€	1 €	cm
20603-S7		50	0,94 €	0,99 €	7

Soporte
de techo
articulado 3 cm

REF	∅	U	€	1 €	cm
20603-SA3		50	0,36 €	0,41 €	3

Soporte
frente-techo
articulado 4 cm

REF	∅	U	€	1 €	cm
20603-SA4		50	0,42 €	0,48 €	

Accesorios / Accessories / Accessoires

Soporte
frente-techo
articulado 7 cm



REF	∅	U	€	€	cm
20603-SA6		50	0,55 €	0,64 €	

Tapa estor



REF	∅	U	€	€	cm
20603-T		100	0,19 €	0,22 €	

Pletina blanca
25 cx 3

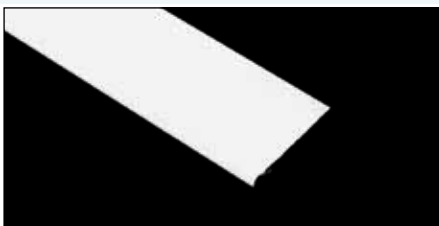

REF	∅	U	€	€	cm
20606-B12006		60 m	3,04 €/m	3,5 €/m	600
20607-TR255		40 m	6,52 €/m	7,50 €/m	400

Varilla de Fibra
4mm

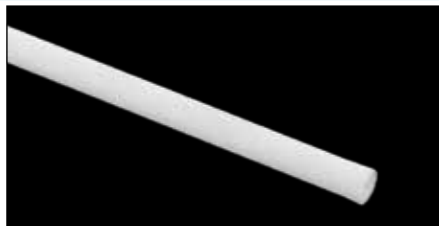

REF	∅	U	€	€	cm
20606-4	4 mm	300 m	0,26 €		600

Freno mini



REF	∅	U	€	€	cm
20603-FRM		50	2,92 €	2,36 €	

Corredera de Plástico

Plastic glider /
Glisseur Plastique



REF	∅	U	€	€	cm
20602-999		1000	0,60 €	0,70 €	

Guía cordón



REF	∅	U	€	€	cm
20602-D780		100	0,52 €	0,60 €	

Codo/empalme
angular



REF	∅	U	€	€	cm
20603-CO		50	1,46 €	1,75 €	

Rulina estor



REF	∅	U	€	€	cm
20603-PH		100	0,24 €	0,28 €	

Accesorios / Accessories / Accessoires

Empalme

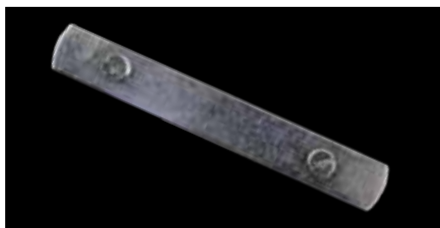

REF	∅				
20603-D30		50	0,96 €	1,11 €	

Soporte botón



REF	∅				
20603-D001		100	0,58 €	0,67 €	

Bola de empalme de plástico



REF	∅				
20603-BE		100	0,46 €	0,53 €	

Tirador



REF	∅				
20603-TI		100	0,16 €	0,18 €	

Contrapeso madera



REF	∅				
20603-TIM		25	1,48 €	1,70 €	

Cordón de 1,5 mm



REF	∅				
20603-CO	1,5 mm	500	0,08 €	0,10 €	

Anilla S plástico



REF	∅				
90606-G		1000	33,66 €/caja		

Anilla de plástico 9x13mm



REF	∅				
20603-D38		1000	33,64 €/caja		

Anilla de lágrima



REF	∅				
20606-1138		1000	33,66 €/caja		

Accesorios / Accessories / Accessoires

Protector de Pletina



REF	∅				
20603-TP		500	0,19 €	0,22 €	

Velcro hembra

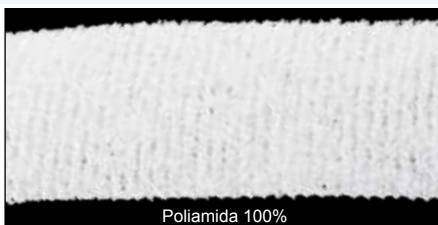

Poliamida 100%

REF	COLOR	rollo (m) roll (m)		
30175-11001	blanco - rígido	50 m	0,40 €/m	20 mm
30175-22001	blanco - suave	50 m	0,44 €/m	20 mm
30175-24001	blanco - superpesado	50 m	0,52 €/m	20 mm

Cinta estor Varilla

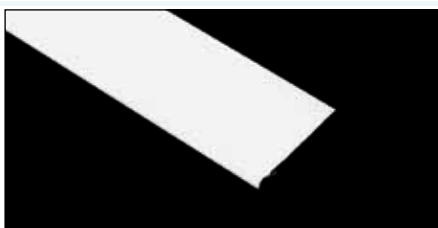

REF	COLOR	rollo (m) roll (m)	Precio (m)	
30178-0160B0CLA01300	blanco	300 m	0,32 €/m	16
30178-0160B0CLA02300	beige	300 m	0,34 €/m	16
30178-0160B0CLA03300	transpar.	300 m	0,40 €/m	16

Cinta estor austriaca paso 5 cm

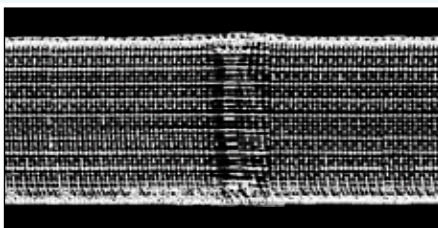

REF	COLOR	rollo (m) roll (m)	Precio (m)	
30178-B2000P5LA03300	transpar.	300 m	0,50 €/m	16

Cinta estor austriaca c/anillas

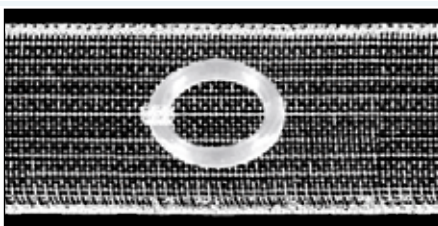

REF	COLOR	rollo (m) roll (m)	Precio (m)	
30177-0161A0CLA03150	transpar.	150 m	0,50 €/m	16

Escuadras blancas



REF	∅				
90609-B30		25	1,32 €	1,52 €	4
90609-B50		25	1,54 €	1,77 €	6
90609-B80		25	2,02 €	2,32 €	10
90609-B120		25	2,65 €	3,05 €	15
90609-B180		25	3,32 €	3,82 €	20

Escuadras extrafuertes



REF	∅				
90609-B3001		25	3,36 €	3,86 €	7
90609-B3002		25	4,04 €	4,65 €	11
90609-B3003		25	4,80 €	5,52 €	15
90609-B3004		25	5,04 €	5,80 €	19
90609-B3005		25	5,24 €	6,03 €	23



Cortinas técnicas verticales

Marvent
SOLUCIONES PARA DECORAR VENTANAS

Ponemos a su disposición una amplia gama de fundas de cojín para darle un toque cálido y confortable a su hogar.



Cojín CAT



Cojín Coordinado Orleans



Cojín Elegance



Cojín Everest



Cojín Himalaya



Cojín Hojas



Cojín Love



Cojín Marina



Cojín Marta



Cojín Orleans



Cojín Questions



Cojín Wonder



Marvent

SOLUCIONES PARA DECORAR VENTANAS

Panel Japonés

sliding panels / paroi japonais



Marvent

SOLUCIONES PARA DECORAR VENTANAS

VENECIANA Y VERTICAL DE MADERA



**La elegancia
de la madera**

Modos de apertura Panel Japonés / Opening modes Sliding Panels / Mode d'ouvertures Paroi Japonaise

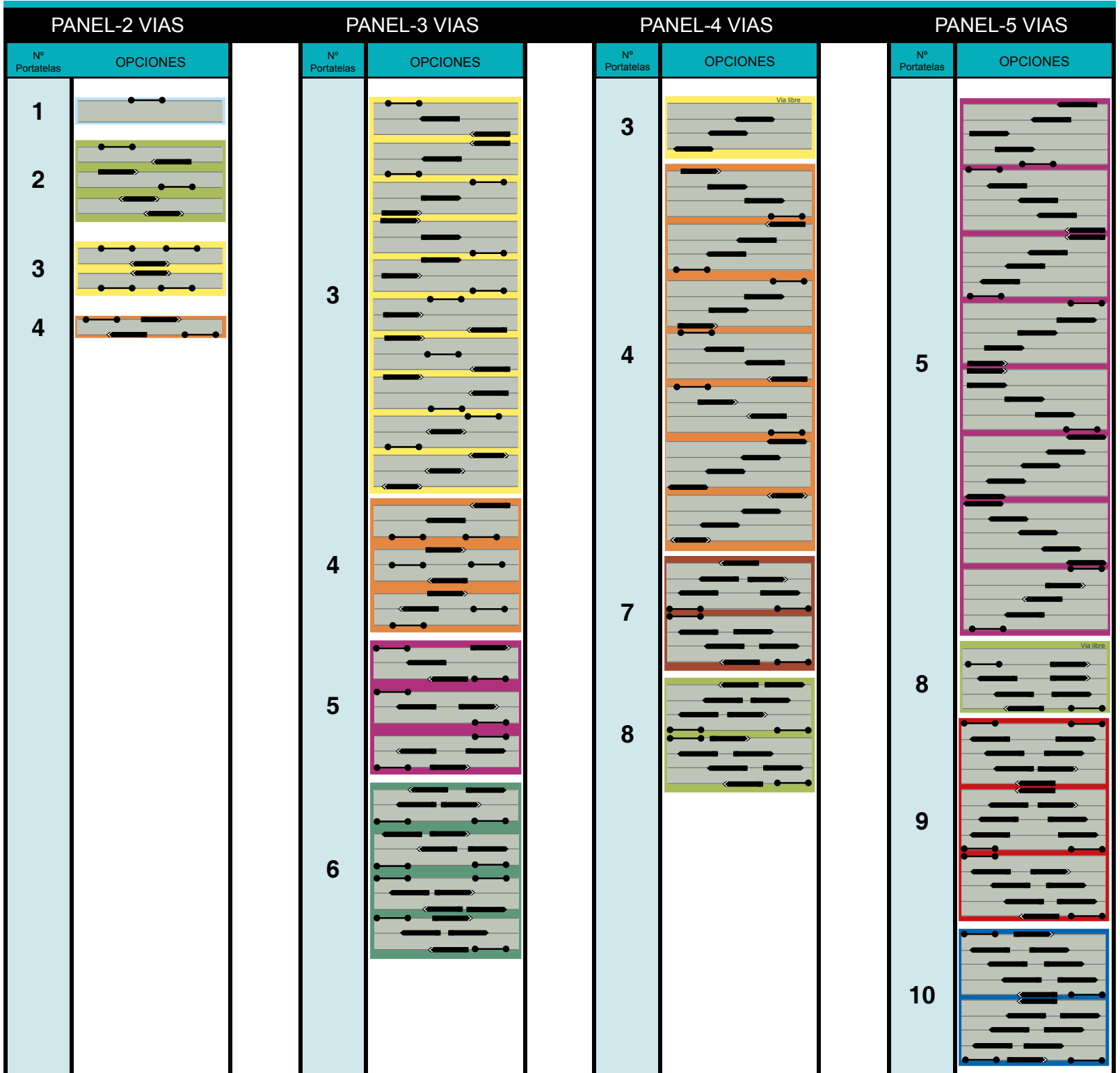

LEYENDA

- Portatela móvil que se desplaza
- hacia la dcha.
 - hacia la izq.
 - hacia dcha e izq.
- Portatelas que arrastra a las otras portatelas móviles
- hacia la dcha.
 - hacia la izq.
 - hacia dcha e izq.
- Fijo
-

LEGEND

- Mobile fabric-holder
- to the right.
 - to the left.
 - right & left.
- Fabric-holder that pulls other fabric holders
- to the right.
 - to the left.
 - right & left.
- Static
-

LEGENDE

- Porte tissu qui se deplace
- vers la droite.
 - vers la gauche.
 - vers droite et gauche.
- Porte tissu qui entraîne les autres porte-tissus
- vers la droite.
 - vers la gauche.
 - vers droite et gauche.
- Porte tissu fixe
-

Panel Japonés 2 VÍAS
Sliding Panel 2 CHANNELS
Parois Japonaise 2 VOIES

Blanco
White
Blanc

Gris
Grey
Gris



Blanco
White/ Blanc

Gris
Grey / Gris

PANEL JAPONÉS 2 VÍAS Conjuntos completos / Complete sets / Kits complets	Blanco White/ Blanc			Gris Grey / Gris			Soportes Brackets Supports	
	REF			REF				
	21626-YM2150	1	40,54 €	21625-YM2150	1	47,60 €	2	150
	21626-YM2200	1	54,20 €	21625-YM2200	1	63,54 €	2	200
	21626-YM2250	1	64,32 €	21625-YM2250	1	75,42 €	3	250
	21626-YM2300	1	73,98 €	21625-YM2300	1	86,88 €	3	300
	21626-YM2350	1	85,70 €	21625-YM2350	1	100,54 €	3	350
	21626-YM2400	1	95,96 €	21625-YM2400	1	116,45 €	4	400
	21626-YM2450	1	106,88 €	21625-YM2450	1	129,78 €	4	450
	21626-YM2600	1	140,12 €	21625-YM2600	1	167,08 €	6	600

Componentes Panel / Panel Components / Composants Paroi

Componentes panel 2 vías:

Perfil 2 vías Longitud
Terminal 2 vías 1
2 Portatelas Velcros (Longitud/2)+5cm

Componentes comunes:

Pletina Aluminio 40x3mm Portatelas - 3cm
Correderas Portatelas 4 x portatela
Topes en L 1 x portatela
Topes en T 1 x portatela
Soportes Ver tabla
Cordón 3mm (Longitud x 2)+3m
Unión blocacuerda 1
Tope con Tornillo 1
Cinta Crip hembra Según Portatelas
Contrapeso 1
Protector Pletina 2 x Pletina
Tapas Portatela 2 (1izq.+1der.)
x Nº Portatelas

2 Channels panel Components:

2 Channel Track Length
2 Channel endcap 1
2 Fabric Holder (Length/2)+5cm

Standard common:

40 x 3 mm. Aluminium Batten Fabric Holders-3cm
Fabric-Holder runners 4 x Fabric Holder
L - shaped endstop 1 x Fabric Holder
T - shaped endstop 1 x Fabric Holder
Brackets See table
3mm Cord (Length x 2)+3m
Cord Connector 1
Endstop w/screw 1
Touch&Close fastener tape Subject to fabric Holders
Leadweight 1
Protector Batten 2 x Batten
Fabric-holder end caps 2 (1 left + 1 right) x
Nº of fabric-holders

Components Paroi 2 voies:

Rail 2 voies Largeur
Bouchon finale 2 voies 1
2 Rail Velcro (Largeur/2)+5cm

Components:

Bâton Aluminium 40 x 3 mm Rail Velcro-3cm
Galet porteur de tissus 4 x Rail Velcro
Arrêt en L 1 x Rail Velcro
Arrêt en T 1 x Rail Velcro
Supports Voir tableau
Corde 3mm (Langeur x 2)+3m
Connecteur de corde 1
Vis finale 1
Velcro femelle Selon porte-tissus
Tendeur rectangulaire 1
Protecteur Barre de Lestage 2 x Barre
Bouchons pour porte-tissus 2 (1 gau.+1 dro.) x
Nº de porte-tissus

Panel Japonés 3 VÍAS
Sliding Panel 3 CHANNELS
Parois Japonaise 3 VOIES



PANEL JAPONÉS
3 VÍAS

Conjuntos completos /
Complete sets /
Kits complets

Opciones:

- 1ª apertura central incrementar 4,5 € por cada portatela
- 2ª incremento por doble mando 3 €
- 3ª incremento por pletina transparente 4 €/m

REF	U	€
21626-YM3150	1	47,30 €
21626-YM3175	1	53,32 €
21626-YM3200	1	61,34 €
21626-YM3225	1	67,28 €
21626-YM3250	1	74,24 €
21626-YM3275	1	79,78 €
21626-YM3300	1	86,70 €
21626-YM3325	1	95,62 €
21626-YM3350	1	98,60 €
21626-YM3375	1	104,91 €
21626-YM3400	1	111,62 €
21626-YM3425	1	121,98 €
21626-YM3450	1	122,92 €
21626-YM3475	1	141,80 €
21626-YM3500	1	147,18 €
21626-YM3550	1	157,24 €
21626-YM3600	1	160,50 €

REF	U	€
21625-YM3150	1	55,60 €
21625-YM3200	1	72,14 €
21625-YM3250	1	87,12 €
21625-YM3300	1	101,72 €
21625-YM3350	1	115,78 €
21625-YM3400	1	131,12 €
21625-YM3450	1	144,36 €
21625-YM3500	1	172,88 €
21625-YM3600	1	187,61 €

Soportes Brackets Supports	cm
3	150
4	175
4	200
4	225
4	250
4	275
4	300
4	325
5	350
5	375
5	400
5	425
5	450
5	475
6	500
6	550
6	600

Componentes Panel / Panel Components / Composants Paroi

Componentes panel 3 vías:

Perfil 3 vías	Longitud
Terminal 3 vías	1
3 Portatelas Velcrados	(Longitud/3)+5cm

Componentes comunes:

Pletina Aluminio 40x3mm	Portatelas - 3cm
Correderas Portatelas	4 x portatela
Topes en L	1 x portatela
Topes en T	1 x portatela
Soportes	Ver tabla
Cordón 3mm	(Longitud x 2)+3m
Unión blocacuerda	1
Tope con Tornillo	1
Cinta Crip hembra	Según Portatelas
Contrapeso	1
Protector Pletina	2 x Pletina
Tapas Portatela	2 (1izq.+1der.) x N° Portatelas

3 Channels panel Components:

3 Channel Track	Length
3 Channel endcap	1
3 Fabric Holder	(Length/3)+5cm

Standard common:

40 x 3 mm. Aluminium Batten	Fabric Holders-3cm
Fabric-Holder runners	4 x Fabric Holder
L - shaped endstop	1 x Fabric Holder
T - shaped endstop	1 x Fabric Holder
Brackets	See table
3mm Cord	(Length x 2)+3m
Cord Connector	1
Endstop w/screw	1
Touch&Close fastener tape	Subject to fabric Holders
Leadweight	1
Protector Batten	2 x Batten
Fabric-holder end caps	2 (1 left + 1 right) x N° of fabric-holders

Components Paroi 3 voies:

Rail 3 voies	Largeur
Bouchon finale 3 voies	1
3 Rail Velcro	(Largeur/3)+5cm

Components:

Bâton Aluminium 40 x 3 mm	Rail Velcro-3cm
Galet porteur de tissus	4 x Rail Velcro
Arrêt en L	1 x Rail Velcro
Arrêt en T	1 x Rail Velcro
Supports	Voir tableau
Corde 3mm	(Langeur x 2)+3m
Connecteur de corde	1
Vis finale	1
Velcro femelle	Selon porte-tissus
Tendeur rectangulaire	1
Protecteur Barre de Lestage	2 x Barre
Bouchons pour porte-tissus	2 (1 gau.+1 dro.) x N° de porte-tissus

KIT Portatelas Estor

Fabric Holder for
roman Blind /

Porte tissus avec
système de store



REF	U	€
D.8001	1	12,24 €

Incremento por KIT de Estor. /
Prices of sets will increase when installing Roman Blind fabric Holders. /
Système Stor Bateau avec hausse de prix.

Panel Japonés 4 VÍAS
Sliding Panel 4 CHANNELS
Parois Japonaise 4 VOIES

Blanco
White
Blanc

Gris
Grey
Gris

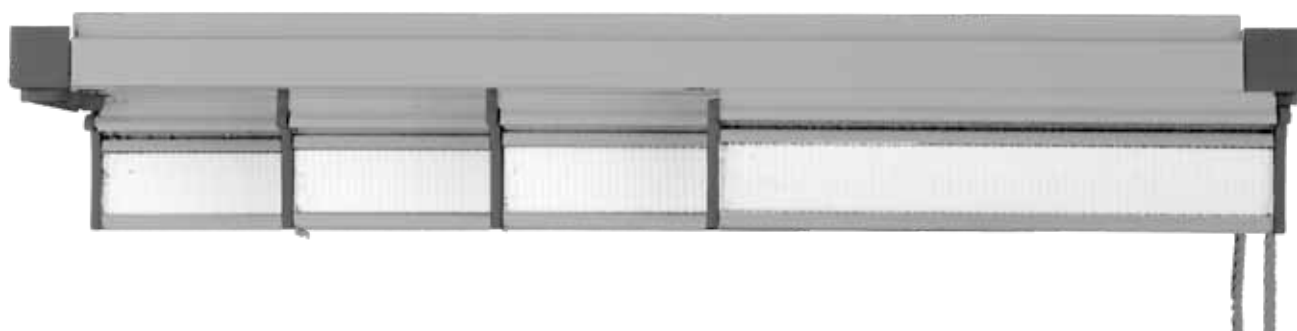

Blanco
White/ Blanc

Gris
Grey / Gris

PANEL JAPONÉS 4 VÍAS

Conjuntos completos /
Complete sets /
Kits complets

Opciones:

- 1ª apertura central incrementar
4,5 € por cada portatela
- 2ª incremento por doble mando
3 €
- 3ª incremento por pletina
transparente 4 €/m

REF		
21626-YM4150	1	54,46 €
21626-YM4175	1	61,60 €
21626-YM4200	1	69,90 €
21626-YM4225	1	77,04 €
21626-YM4250	1	83,60 €
21626-YM4275	1	91,14 €
21626-YM4300	1	97,44 €
21626-YM4325	1	104,58 €
21626-YM4350	1	111,14 €
21626-YM4375	1	118,68 €
21626-YM4400	1	125,98 €
21626-YM4425	1	132,32 €
21626-YM4450	1	138,68 €
21626-YM4475	1	163,76 €
21626-YM4500	1	167,74 €
21626-YM4550	1	179,66 €
21626-YM4600	1	181,46 €

REF		
21625-YM4150	1	63,94 €
21625-YM4200	1	82,04 €
21625-YM4250	1	98,06 €
21625-YM4300	1	114,46 €
21625-YM4350	1	130,36 €
21625-YM4400	1	147,78 €
21625-YM4450	1	162,82 €
21625-YM4500	1	196,98 €
21625-YM4600	1	212,52 €

Soportes Brackets Supports	
3	150
4	175
4	200
4	225
4	250
4	275
4	300
4	325
5	350
5	375
5	400
5	425
5	450
5	475
6	500
6	550
6	600

Componentes Panel / Panel Components / Composants Paroi

Componentes panel 4 vías:

Perfil 4 vías Longitud
Terminal 4 vías 1
4 Portatelas Velcrados (Longitud/4)+5cm

Componentes comunes:

Pletina Aluminio 40x3mm Portatelas - 3cm
Correderas Portatelas 4 x portatela
Topes en L 1 x portatela
Topes en T 1 x portatela
Soportes Ver tabla
Cordón 3mm (Longitud x 2)+3m
Unión blocacuerda 1
Tope con Tornillo 1
Cinta Crip hembra Según Portatelas
Contrapeso 1
Protector Pletina 2 x Pletina
Tapas Portatela 2 (1izq.+1der.)
x Nº Portatelas

4 Channels panel Components:

4 Channel Track.....Length
4 Channel endcap.....1
4 Fabric Holder.....(Length/4)+5cm

Standard common:

40 x 3 mm. Aluminium Batten..... Fabric Holders-3cm
Fabric-Holder runners..... 4 x Fabric Holder
L - shaped endstop..... 1 x Fabric Holder
T - shaped endstop..... 1 x Fabric Holder
Brackets..... See table
3mm Cord..... (Length x 2)+3m
Cord Connector.....1
Endstop w/screw.....1
Touch&Close fastener tape..... Subject to fabric Holders
Leadweight..... 1
Protector Batten..... 2 x Batten
Fabric-holder end caps 2 (1 left + 1 right) x
Nº of fabric-holders

Components Paroi 4 voies:

Rail 4 voies.....Largeur
Bouchon finale 4 voies.....1
4 Rail Velcro.....(Largeur/4)+5cm

Components:

Bâton Aluminium 40 x 3 mm..... Rail Velcro-3cm
Galet porteur de tissus..... 4 x Rail Velcro
Arrêt en L..... 1 x Rail Velcro
Arrêt en T..... 1 x Rail Velcro
Supports..... Voir tableau
Corde 3mm..... (Langeur x 2)+3m
Connecteur de corde..... 1
Vis finale..... 1
Velcro femelle..... Selon porte-tissus
Tendeur rectangulaire..... 1
Protecteur Barre de Lestage..... 2 x Barre
Bouchons pour porte-tissus 2 (1 gau.+1 dro.) x
Nº de porte-tissus

KIT Portatelas Estor

Fabric Holder for
roman Blind /

Porte tissus avec
système de store



REF



D.8001

1

12,24 €

Incremento por KIT de Estor. /
Prices of sets will increase when installing Roman Blind fabric Holders. /
Système Stor Bateau avec hausse de prix.

Panel Japonés 5 VÍAS
Sliding Panel 5 CHANNELS
Parois Japonaise 5 VOIES



Blanco
White/ Blanc

Gris
Grey / Gris

PANEL JAPONÉS
5 VÍAS

Conjuntos completos /
Complete sets /
Kits complets

Opciones:

- 1ª apertura central incrementar
4,5 € por cada portatela
- 2ª incremento por doble mando
3 €
- 3ª incremento por pletina
transparente 4 €/m

REF	U	€
21626-YM5150	1	61,36 €
21626-YM5175	1	69,06 €
21626-YM5200	1	76,68 €
21626-YM5225	1	86,18 €
21626-YM5250	1	93,46 €
21626-YM5275	1	100,42 €
21626-YM5300	1	107,54 €
21626-YM5325	1	116,68 €
21626-YM5350	1	123,76 €
21626-YM5375	1	130,08 €
21626-YM5400	1	139,00 €
21626-YM5425	1	146,98 €
21626-YM5450	1	154,46 €
21626-YM5475	1	169,34 €
21626-YM5500	1	188,06 €
21626-YM5550	1	208,76 €
21626-YM5600	1	200,18 €

REF	U	€
21625-YM5150	1	71,84 €
21625-YM5200	1	89,86 €
21625-YM5250	1	109,56 €
21625-YM5300	1	126,30 €
21625-YM5350	1	145,18 €
21625-YM5400	1	163,54 €
21625-YM5450	1	181,22 €
21625-YM5500	1	220,70 €
21625-YM5600	1	234,76 €

Soportes Brackets Supports	cm
3	150
4	175
4	200
4	225
4	250
4	275
4	300
4	325
5	350
5	375
5	400
5	425
5	450
5	475
6	500
6	550
6	600

Componentes Panel / Panel Components / Composants Paroi

Componentes panel 5 vías:

Perfil 5 vías	Longitud
Terminal 5 vías	1
5 Portatelas Velcrados	(Longitud/5)+5cm

Componentes comunes:

Pletina Aluminio 40x3mm	Portatelas - 3cm
Correderas Portatelas	4 x portatela
Topes en L	1 x portatela
Topes en T	1 x portatela
Soportes	Ver tabla
Cordón 3mm	(Longitud x 2)+3m
Unión blocacuerda	1
Tope con Tornillo	1
Cinta Crip hembra	Según Portatelas
Contrapeso	1
Protector Pletina	2 x Pletina
Tapas Portatela	2 (1izq.+1der.) x N° Portatelas

5 Channels panel Components:

5 Channel Track	Length
5 Channel endcap	1
5 Fabric Holder	(Length/5)+5cm

Standard common:

40 x 3 mm. Aluminium Batten	Fabric Holders-3cm
Fabric-Holder runners	4 x Fabric Holder
L - shaped endstop	1 x Fabric Holder
T - shaped endstop	1 x Fabric Holder
Brackets	See table
3mm Cord	(Length x 2)+3m
Cord Connector	1
Endstop w/screw	1
Touch&Close fastener tape	Subject to fabric Holders
Leadweight	1
Protector Batten	2 x Batten
Fabric-holder end caps	2 (1 left + 1 right) x N° of fabric-holders

Components Paroi 5 voies:

Rail 5 voies	Largeur
Bouchon finale 5 voies	1
5 Rail Velcro	(Largeur/5)+5cm

Components:

Bâton Aluminium 40 x 3 mm	Rail Velcro-3cm
Galet porteur de tissus	4 x Rail Velcro
Arrêt en L	1 x Rail Velcro
Arrêt en T	1 x Rail Velcro
Supports	Voir tableau
Corde 3mm	(Langeur x 2)+3m
Connecteur de corde	1
Vis finale	1
Velcro femelle	Selon porte-tissus
Tendeur rectangulaire	1
Protecteur Barre de Lestage	2 x Barre
Bouchons pour porte-tissus	2 (1 gau.+1 dro.) x N° de porte-tissus

KIT Portatelas Estor

Fabric Holder for
roman Blind /

Porte tissus avec
système de store

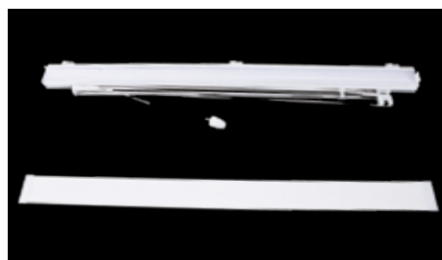

REF	U	€
D.8001	1	12,24 €

Incremento por KIT de Estor. /
Prices of sets will increase when installing Roman Blind fabric Holders. /
Système Stor Bateau avec hausse de prix.





Accesorios / Accessories / Accessoires

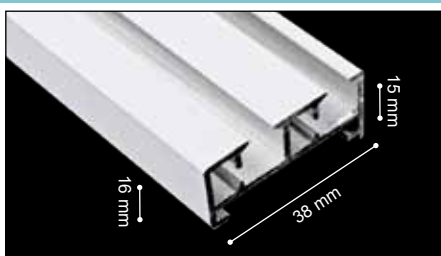

Perfil de Aluminio 2 vías (38x20mm)

2 Channel Aluminium Track / Rail Aluminium 2 voies





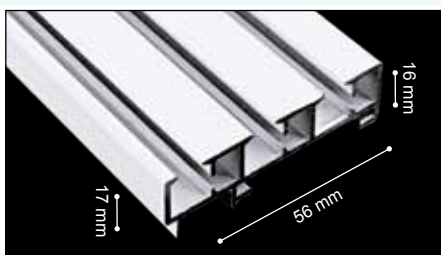

REF	Ø				
21625-120142GR		60 m	9,50 €	10,93 €	600

Perfil de Aluminio 3 vías (57x20mm)

3 Channel Aluminium Track / Rail Aluminium 3 voies





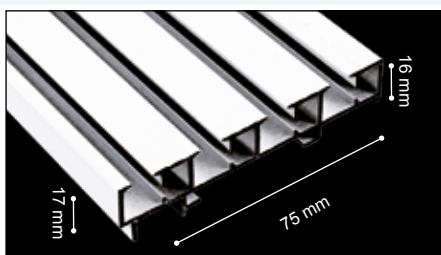

REF	Ø				
21626-120143BL		60 m	10,04 €/m	11,04 €/m	600
21625-120143GR		60 m	12,83 €/m	14,11 €/m	600

Perfil de Aluminio 4 vías (73x20mm)

4 Channel Aluminium Track / Rail Aluminium 4 voies





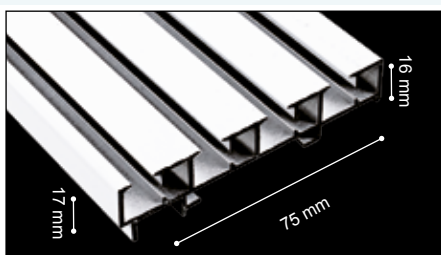

REF	Ø				
21626-120144BL		60 m	13,24 €/m	14,56 €/m	600
21625-120144GR		60 m	16,79 €/m	18,47 €/m	600

Perfil de Aluminio 5 vías (73x20mm)

5 Channel Aluminium Track / Rail Aluminium 5 voies







REF	Ø				
21625-120145GR		60 m	20,80 €	23,92 €	600

Terminal 2 vías

2 Channel endcap / Bouchon finale 2 voies







REF	Ø				
21625-912GR		50 pares	1,80 €	2,07 €	

Terminal 3 vías

3 Channel endcap / Bouchon finale 3 voies







REF	Ø				
21626-913		50 pares	1,30 €	1,43 €	
21625-913GR		50 pares	3,64 €	4,00 €	

Terminal 4 vías

4 Channel endcap / Bouchon finale 4 voies







REF	Ø				
21626-914		50 pares	1,42 €	1,56 €	
21625-914GR		50 pares	4,08 €	4,49 €	

Terminal 5 vías

5 Channel endcap / Bouchon finale 5 voies



REF	Ø				
21625-915GR		50 pares	2,20 €	2,53 €	

PASAMANERÍA

Servicio bajo pedido por piezas.

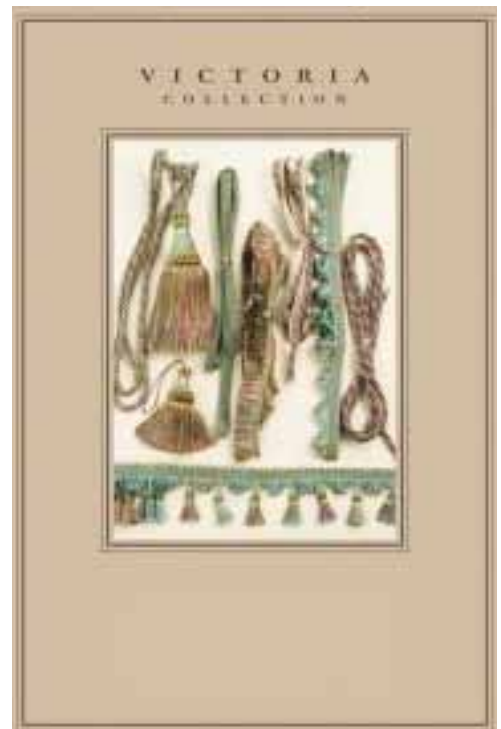
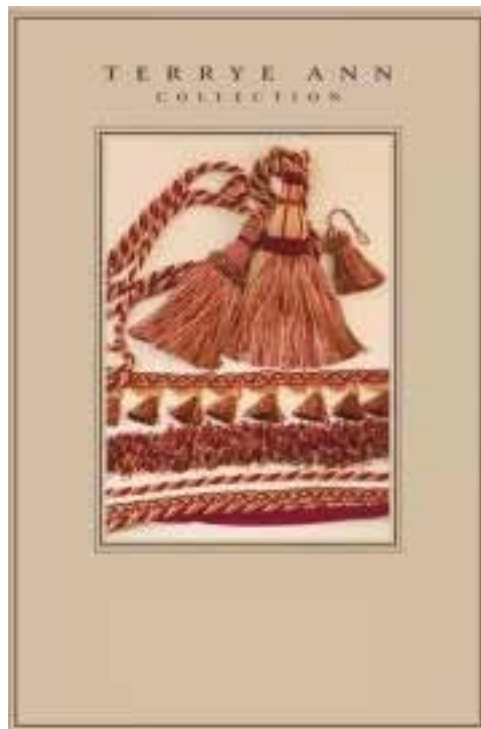
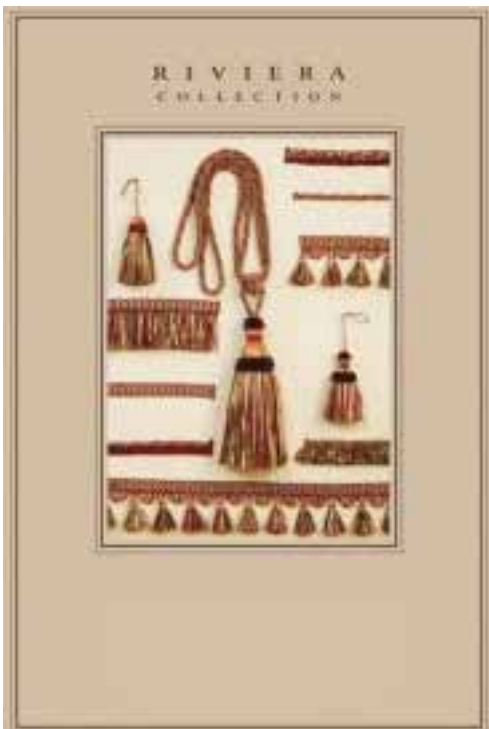
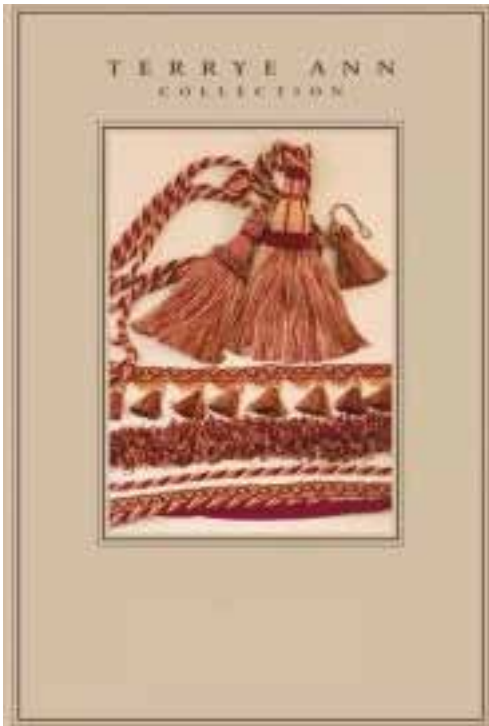

Marvent

SOLUCIONES PARA DECORAR VENTANAS

Accesorios / Accessories / Accessoires



Perfil Portateclas de Aluminio

Aluminium
Fabric Holder /
Porte-tissu



REF	∅				
21626-12002BL		60 m	5,00 €/m	5,5 €/m	600
21626-12002GR		60 m	5,88 €/m	6,47 €/m	600

Pletina Contrapeso de Aluminio

Fabric Holder /
Rail Aluminium Velcro

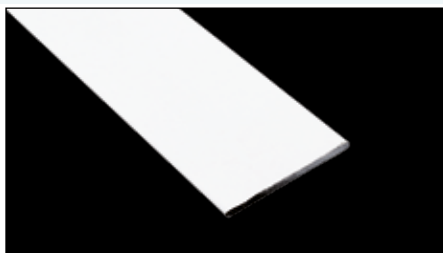

REF	∅				
21626-12001BL		60 m	4,74 €/m	5,22 €/m	600

Pletina Contrapeso Metacrilato Transp. (40x5mm)

Transparent acrylic
Batten (40x5mm) /
Barre de
metacrylate
transparente (40x5mm)

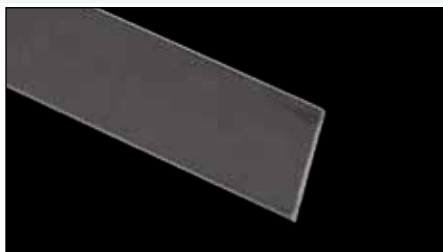

REF	∅				
21626-TR405		40	8,92 €/m	10,26 €/m	400

Cinta Velcro Hembra Velour 20 mm

Touch&Close Fastener
Tape (Loop Section) /
Velcro femelle velour

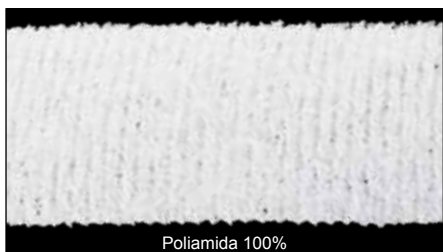

REF	COLOR		rollo (m) roll (m)	Precio/m	
30175-11001	blanco/white	rígido	50 m	0,40 €/m	20 mm
30175-22001	blanco/white	suave	50 m	0,44 €/m	20 mm
30175-24001	blanco/white	superpes	50 m	0,52 €/m	20 mm

Rollo 250m. de Cordón 3,5 mm.

Roll of 250m. of 3,5
mm cord /
250m. corde 3,5 mm.



REF	∅		caja		
21626-035			250 m	0,22 €/m	

Rollo 250m. de Cordón 3,5 mm.

Roll of 250m. of 3,5
mm cord /
250m. corde 3,5 mm.



REF	∅		caja		
21625-035GR			250 m	0,22 €/m	

Unión Blocacuerda

Cord Connector/
Connecteur
pour corde



REF	∅	caja			
21626-96		100 m	0,78 €/m	0,86 €/m	

Tope L

L-shaped Enstop /
Arrêt en L



REF	∅				
21626-94		100	0,42 €	0,46 €	
21625-94GR		100	0,46 €	0,51 €	

Accesorios / Accessories / Accessoires



<p>Topo T T-shaped Enstop / Arrêt en T</p>		<table border="1"> <thead> <tr> <th>REF</th> <th>∅</th> <th>U</th> <th>€</th> <th>€</th> <th>cm</th> </tr> </thead> <tbody> <tr> <td>21626-95</td> <td></td> <td>100</td> <td>0,42 €</td> <td>0,46 €</td> <td></td> </tr> <tr> <td>21625-95GR</td> <td></td> <td>100</td> <td>0,46 €</td> <td>0,51 €</td> <td></td> </tr> </tbody> </table>	REF	∅	U	€	€	cm	21626-95		100	0,42 €	0,46 €		21625-95GR		100	0,46 €	0,51 €	
REF	∅	U	€	€	cm															
21626-95		100	0,42 €	0,46 €																
21625-95GR		100	0,46 €	0,51 €																
<p>Correderas Portatelas Fabric-Holder Runner / Glisseur Porteur de Tissus</p>		<table border="1"> <thead> <tr> <th>REF</th> <th>∅</th> <th>U</th> <th>€</th> <th>€</th> <th>cm</th> </tr> </thead> <tbody> <tr> <td>21626-92</td> <td></td> <td>100</td> <td>0,34 €</td> <td>0,38 €</td> <td></td> </tr> </tbody> </table>	REF	∅	U	€	€	cm	21626-92		100	0,34 €	0,38 €							
REF	∅	U	€	€	cm															
21626-92		100	0,34 €	0,38 €																
<p>Tornillo topo acetal Endstop w/screw / Vis finale</p>		<table border="1"> <thead> <tr> <th>REF</th> <th>∅</th> <th>U</th> <th>€</th> <th>€</th> <th>cm</th> </tr> </thead> <tbody> <tr> <td>21626-TA</td> <td></td> <td>100</td> <td>0,30 €</td> <td>0,33 €</td> <td></td> </tr> </tbody> </table>	REF	∅	U	€	€	cm	21626-TA		100	0,30 €	0,33 €							
REF	∅	U	€	€	cm															
21626-TA		100	0,30 €	0,33 €																
<p>Soporte 2/3 vías Bracket 2/3 channel / Support 2/3 voies</p>		<table border="1"> <thead> <tr> <th>REF</th> <th>∅</th> <th>U</th> <th>€</th> <th>€</th> <th>cm</th> </tr> </thead> <tbody> <tr> <td>21626-SP</td> <td></td> <td>100</td> <td>0,80 €</td> <td>0,88 €</td> <td></td> </tr> </tbody> </table> <p>* Soporte que se utiliza en el montaje / Bracket supplied in the kit / Support fourni dans le kit.</p>	REF	∅	U	€	€	cm	21626-SP		100	0,80 €	0,88 €							
REF	∅	U	€	€	cm															
21626-SP		100	0,80 €	0,88 €																
<p>Soporte 4/5 vías Bracket 4/5 channel / Support 4/5 voies</p>		<table border="1"> <thead> <tr> <th>REF</th> <th>∅</th> <th>U</th> <th>€</th> <th>€</th> <th>cm</th> </tr> </thead> <tbody> <tr> <td>21626-SP23</td> <td></td> <td>100</td> <td>0,82 €</td> <td>0,90 €</td> <td></td> </tr> </tbody> </table> <p>* Soporte que se utiliza en el montaje / Bracket supplied in the kit / Support fourni dans le kit.</p>	REF	∅	U	€	€	cm	21626-SP23		100	0,82 €	0,90 €							
REF	∅	U	€	€	cm															
21626-SP23		100	0,82 €	0,90 €																
<p>Protector de Pletina 3x40 Protector Batten 3x40 / Protecteur Barre de lestage 3x40</p>		<table border="1"> <thead> <tr> <th>REF</th> <th>∅</th> <th>U</th> <th>€</th> <th>€</th> <th>cm</th> </tr> </thead> <tbody> <tr> <td>21626-TP</td> <td></td> <td>100</td> <td>0,20 €</td> <td>0,22 €</td> <td></td> </tr> </tbody> </table>	REF	∅	U	€	€	cm	21626-TP		100	0,20 €	0,22 €							
REF	∅	U	€	€	cm															
21626-TP		100	0,20 €	0,22 €																
<p>Tapa Portatela Derecha (D), Izquierda (I) Right (D), Left (I) End- cap Fabric Holders / Bouchon Porte-Tissus droite(D), Gauche I)</p>		<table border="1"> <thead> <tr> <th>REF</th> <th>∅</th> <th>U</th> <th>€</th> <th>€</th> <th>cm</th> </tr> </thead> <tbody> <tr> <td>21626-T</td> <td></td> <td>100</td> <td>0,30 €</td> <td>0,33 €</td> <td></td> </tr> </tbody> </table>	REF	∅	U	€	€	cm	21626-T		100	0,30 €	0,33 €							
REF	∅	U	€	€	cm															
21626-T		100	0,30 €	0,33 €																
<p>Adaptador Tirador Clip / Glisseur Lance Rideau</p>		<table border="1"> <thead> <tr> <th>REF</th> <th>∅</th> <th>U</th> <th>€</th> <th>€</th> <th>cm</th> </tr> </thead> <tbody> <tr> <td>21626-ST1</td> <td></td> <td>100</td> <td>1,24 €</td> <td>1,37 €</td> <td></td> </tr> </tbody> </table>	REF	∅	U	€	€	cm	21626-ST1		100	1,24 €	1,37 €							
REF	∅	U	€	€	cm															
21626-ST1		100	1,24 €	1,37 €																



Accesorios / Accessories / Accessoires



Soporte de Plástico

Plastic Bracket /
Support en Plastique





REF	∅				vías
21626-983		100	0,80 €	0,88 €	2-3
21626-9845		100	0,82 €	0,90 €	4-5

Soporte Metálico

Metal Bracket /
Support Métallique







REF	∅				vías
21626-932		100	0,60 €	0,66 €	2
21626-9345		100	0,62 €	0,68 €	3-4-5

Empalme

Splice /
raccordeur





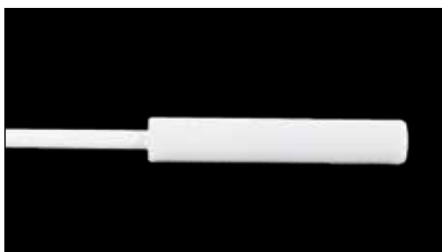

REF	∅				
21626-91		10	3,18 €	3,66 €	

Tirador

Wand /
Lance rideau





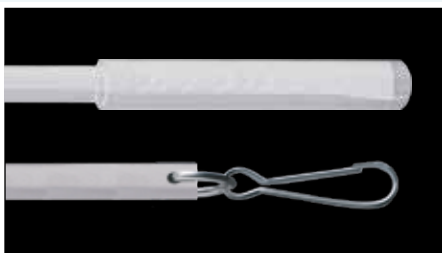

REF	∅				
90609-TI		25	2,00 €	2,30 €	100
90609-TI150		25	3,14 €	3,61 €	150

Tirador Metacrilato

Methacrylate Wand /
Lance Rideau
Méthacrylate







REF	∅				
01375-TTI		1		17,70 €	100

Tensor Rectangular

Cordweight /
Tendeur
Rectangulaire





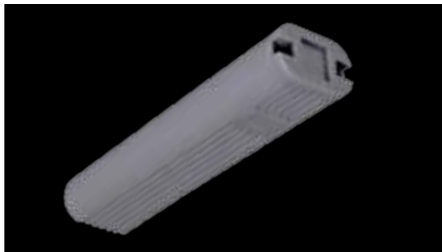

REF	∅				
22619-1150		25	1,48 €	1,78 €	

Tensor Rectangular

Cordweight /
Tendeur
Rectangulaire



REF	∅				
22619-1150GR		25	1,66 €	1,99 €	

Accesorios / Accessories / Accessoires



Galería 7 cm.
Pelmet 7cm. /
Cantonnière 7cm.



REF	∅	U	€	€	cm
C.12013BL		60 m	6,32 €	*	
C.12013		60 m	6,74 €	*	

Muestra
Panel Japonés
Blanco

Demo Sample
white Sliding Panel /
Échantillon
Paroi Japonise Blanc



REF	∅	U	€	€	cm
M.4		1		*	

Muestra
Panel Japonés
Blanco

Demo Sample
Grey Sliding Panel /
Échantillon
Paroi Japonise Grey

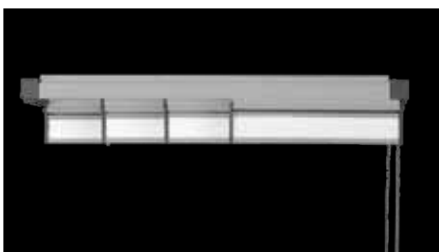

REF	∅	U	€	€	cm
M.4AP		1		*	

*Solo se suministra en unidad de embalaje



Marvent
SOLUCIONES PARA DECORAR VENTANAS

**CORTINA VENECIANA
DE MADERA**

Protección solar
creando zonas cálidas
y confortables,
embelleciendo el
ambiente y dándole
un toque personal a tu
casa.

CODIGO CLIENTE..... NOMBRE CLIENTE.....

FECHA PEDIDO..... POBLACIÓN.....

OBSERVACIONES.....

REFERENCIA	CANTIDAD	MEDIDA PANEL	Nº Vías	Nº TOTAL PORTATELAS	MEDIDA(2) PORTATELAS	PORTATELAS EXTRA			¿MOTOR?
						POSICIÓN PORTATELA FIJO	POSICIÓN CUERDA	SISTEMA ESTOR 11.8000	
						DERECHA IZQUIERDA CENTRAL	DERECHA IZQUIERDA	DERECHA IZQUIERDA	
						DERECHA IZQUIERDA CENTRAL	DERECHA IZQUIERDA	DERECHA IZQUIERDA	
						DERECHA IZQUIERDA CENTRAL	DERECHA IZQUIERDA	DERECHA IZQUIERDA	
						DERECHA IZQUIERDA CENTRAL	DERECHA IZQUIERDA	DERECHA IZQUIERDA	
						DERECHA IZQUIERDA CENTRAL	DERECHA IZQUIERDA	DERECHA IZQUIERDA	

(1) DEBE AÑADIRSE EN EL PEDIDO EL RESULTADO DE ESTAS CASILLAS CON SUS CÓDIGOS CORRESPONDIENTES.

(2) RELLENAR SÓLO SI EL CLIENTE LO ESPECIFICA

NOTA: EL STANDARD DE MONTAJE DE PANEL ES EL SIGUIENTE:

SISTEMA DE CUERDA (1,5M)

SISTEMA DE INSTALACIÓN TRASERO

PORTATELAS FIJO EN POSICIÓN DELANTERA

MEDIDA PORTATELAS=(MEDIDA PANEL/NºPORTATELAS)+5CM

SIMBOLOGÍA



Modos de apertura Panel Japonés / Opening modes Sliding Panels / Mode d'ouvertures Paroi Japonaise

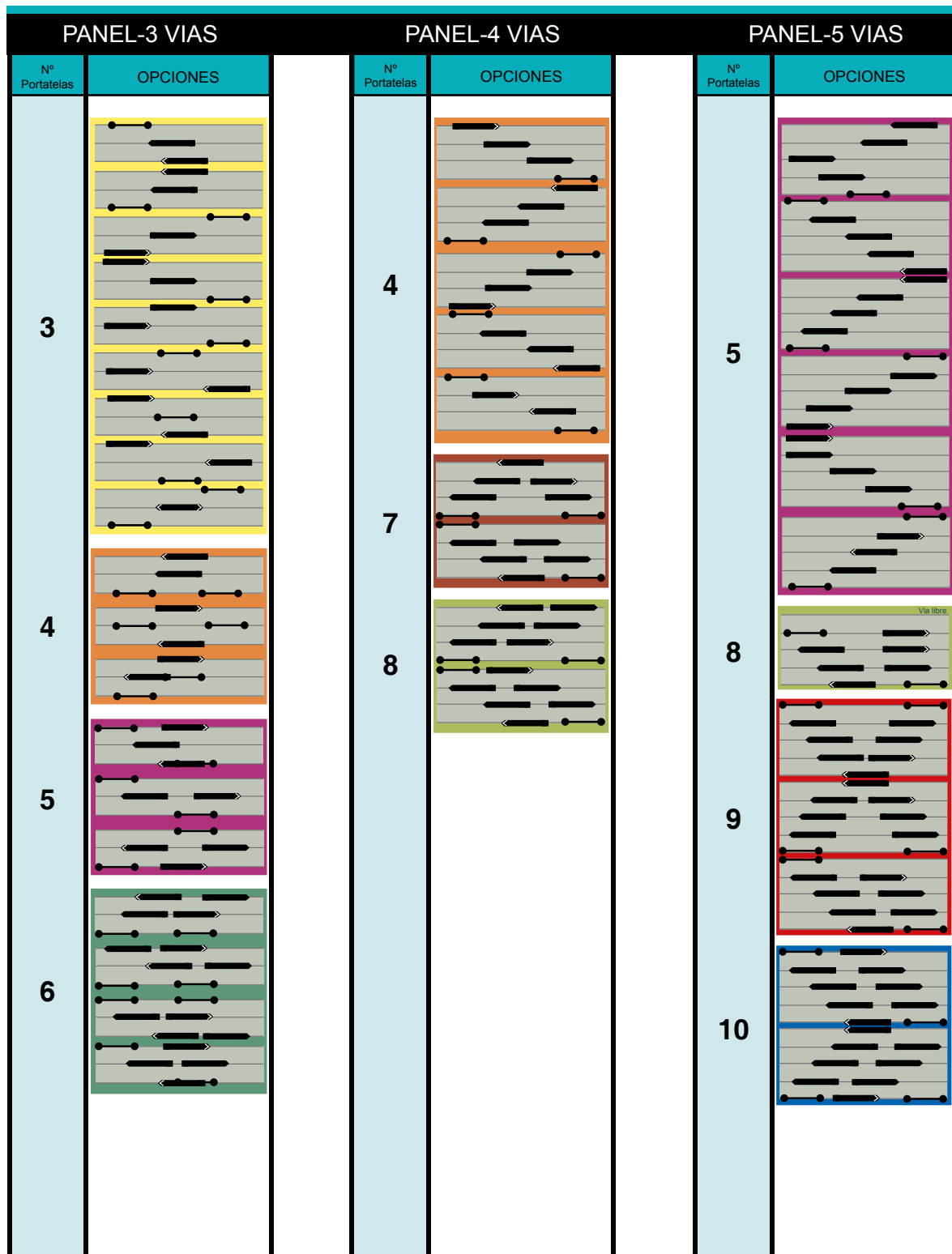

LEYENDA

Portatela móvil que se desplaza

- hacia la dcha.
- hacia la izq.
- hacia dcha e izq.

Portatelas que arrastra a las otras portatelas móviles

- hacia la dcha.
- hacia la izq.
- hacia dcha e izq.

Fijo

-

LEGEND

Mobile fabric-holder

- to the right.
- to the left.
- right & left.

Fabric-holder that pulls other fabric holders

- to the right.
- to the left.
- right & left.

Static

-

LEGENDE

Porte tissu qui se deplace

- vers la droite.
- vers la gauche.
- vers droite et gauche.

Porte tissu qui entraîne les autres porte-tissus

- vers la droite.
- vers la gauche.
- vers droite et gauche.

Porte tissu fixe

-

Características Generales / Main features / Caractéristiques Principales

 **El Panel Japonés Motorizado** está equipado con el **motor AS-04** de última generación apto tanto para uso doméstico, como comercial o industrial, debido a sus altas prestaciones.

El motor está diseñado para usar perfiles de 3, 4 ó 5 vías.

El largo máximo en el que fabricamos el panel es de 5,70 metros sin emplear ningún tipo de empalme.

Por el interior del perfil circula una correa dentada muy resistente por lo que la transmisión del desplazamiento es perfecta y muy silenciosa. Además, recubrimos el interior del perfil con un barniz que disminuye todavía más el rozamiento y por tanto, el ruido. Por otra parte, las correderas empleadas disponen de unas ruedas que facilitan el fluir de la cortina.

Cuenta con un detector automático de los límites finales de la carrera donde debe iniciarse la apertura y el cierre del panel. Esta función se puede programar también manualmente.

Opcionalmente se puede solicitar o bien un mando a distancia de 7 canales o un pulsador de pared de 2 canales. El mando a distancia tiene un alcance de 30 metros. La programación del sistema es muy fácil y rápida. Ambos sistemas pueden incluirse dentro del paquete de tecnología domótica que se esté empleando en el lugar de la instalación (consulte el manual de instrucciones).

El panel se sirve cortado a medida y preparado para el modo de apertura deseado: apertura izquierda o apertura derecha. El motor estará colocado a la derecha del perfil.

Otras características técnicas:

- Voltaje: 24VDC
- Velocidad: 95RPM
- Par torsor: 1 Nm
- Índice de Protección: IP41
- Peso: 0,56 Kg
- Receptor integrado en el motor.
- Final de carrera electrónico.
- Dispositivo térmico de protección contra sobrecargas eléctricas.
- Parada automática del sistema al finalizar su recorrido.
- Motor asincrónico, libre de interferencias.

Altran ofrece una Garantía de 2 años para todos sus Motores, a partir de la fecha de factura, salvo mal uso o rotura por parte del cliente-usuario-instalador.

Disponemos de información técnica adicional sobre este producto. Solicítela en caso de estar interesado.

We have at your disposal additional technical information about this product. Please, ask for it in case of interest.

Nous mettons à votre disposition des informations techniques supplémentaires sur ce produit. S'il vous plaît demander en cas d'intérêt.

 The **Motorized Sliding Panel** is equipped with the last generation **motor AS-04**, suitable for domestic, commercial or industrial purposes, due to its great performance.

The motor is designed to be used in tracks of 3, 4 and 5 channels. The maximum length in one piece is 5.70mts.

A high-resistance timing belt runs inside the guide profile thus ensuring a perfect and silent sliding. Moreover, the guide profile is coated with a special varnish that decreases friction and noise. On the other hand, the runners used are wheeled, fact that facilitates the sliding of the curtain.

It includes an automatic detector of the opening and closing limit switches. This function can be programmed also manually.

Optionally a 7channels remote control or a 2channels wall switch can be ordered separately. The operating range of the remote control unit is 30 metres. The programming is very easy and quick. Both systems can be included in a domotic or home automation system installation (Pls refer to the instruction manual).

The track is supplied cut to measure and prepared for the desired opening mode: towards left or towards right. The motor will be placed in the right side.

Altran offers a 2 year warranty for all motors, from the date of invoice, unless misuse or failure by the customer-user-installer.

 Le **Panneau Japonais** est équipé d'un **moteur de dernière génération AS-04**, apte tant pour un usage domestique comme commercial et industriel grâce à ses grandes prestations.

Le moteur est dessiné pour son usage dans rails de 3, 4 et 5 voies. La longueur maximale dans une seule pièce est 5.70mts.

Dans l'intérieur du profil une courroie dentée très résistante circule en octroyant une touche de silence et de glissement parfait au système. De plus, la guide intérieure est recouverte d'un vernis spécial qui diminue le frottement et comme conséquence le bruit. Par ailleurs, les guidages coulissants facilitent le glissement du rideau.

Le système dispose d'un détecteur automatique des commutateurs de fin de course où on doit initier l'ouverture et la fermeture du panneau. Cette fonction peut être programmée aussi manuellement.

On peut optionnellement solliciter ou bien une télécommande de 7 canaux ou interrupteur mural manuel de 2 canaux. La portée de la télécommande est de 30 metres au maximum. La programmation du système est très facile et rapide. Les deux systèmes peuvent s'incorporer aux installations domotiques (SVP consultez le manuel d'instructions).

Le panneau se sert coupé sur mesure et préparé à la manière désirée d'ouverture: ramassage à gauche ou à droite. Le moteur sera placé dans le côté droit.

Altran offre une garantie de 2 ans pour tous les moteurs, à partir de la date de la facture, sauf utilisation incorrecte ou rupture de la part du client-utilisateur-installateur.

Additional technical specifications:

- Voltage: 24VDC.
- Speed: 95 RPM.
- Torque : 1 Nm.
- Protection rating : IP41.
- Weight: 0,56 Kg.
- Built-in receiver.
- 2 intermediate programmable positions.
- Automatic limit switch.
- Thermal overload protection.
- Built-in automatic start/stop.
- Asynchronous motor, interference-free.
- Store and recall job programming if power failure.

Autres caractéristiques techniques:

- Voltage: 24VDC .
- Vitesse: 95 RPM.
- Force de tension: 1 Nm.
- Classe de protection: IP41.
- Poids : 0,56 Kg.
- Récepteur intégré au moteur.
- 2 positions intermédiaires programmables.
- Fin de course électronique.
- Dispositif thermique de protection contre surcharges électriques.
- Arrêt automatique du système a la fin de course.
- Moteur asynchrone, sans interférence.
- Mémoire de programmation en cas d'absence d'électricité.

Panel Japonés Motorizado 3-4-5 VÍAS
 Motorized Sliding Panel 3-4-5 CHANNELS
 Parois Japonaise Motorisé 3-4-5 VOIES

Blanco
 White
 Blanc



*** Los precios incluyen transformador y soporte del transformador.**
 AC adapter and cradle included in the price.
 Adaptateur AC et support inclus dans le prix.

PANEL JAPONÉS MOTORIZADO 3-4-5 VÍAS

Conjuntos completos /
 Complete sets /
 Kits complets

*** No cobramos incremento para portatela extra o doble mando. /**
*** We do not charge any supplement for double cord or extra fabric-holders. /**
*** Des porte-tissus extra ou double cordes sont fournis sans frais supplémentaires**

Conjuntos Completos 3 Vías Complete Sets 3 channels Kits Complets 3 voies			Conjuntos Completos 4 Vías Complete Sets 4 channels / Kits Complets 4 voies			Conjuntos Completos 5 Vías Complete Sets 5 channels / Kits Complets 5 voies			Soportes Brackets Supports	
REF	U	€	REF	U	€	REF	U	€	cm	cm
E.81503	1	573,20 €	E.81504	1	586,82 €	E.81505	1	599,68 €	3	150
E.82003	1	599,78 €	E.82004	1	616,06 €	E.82005	1	631,30 €	4	200
E.82503	1	624,32 €	E.82504	1	643,22 €	E.82505	1	660,90 €	4	250
E.83003	1	650,60 €	E.83004	1	672,76 €	E.83005	1	692,78 €	4	300
E.83503	1	677,18 €	E.83504	1	701,96 €	E.83505	1	724,40 €	5	350
E.84003	1	701,70 €	E.84004	1	729,14 €	E.84005	1	753,96 €	5	400
E.84503	1	726,26 €	E.84504	1	756,34 €	E.84505	1	783,56 €	5	450
E.85003	1	752,84 €	E.85004	1	785,56 €	E.85005	1	815,20 €	6	500
E.85703	1	787,18 €	E.85704	1	823,62 €	E.85705	1	856,60 €	6	600

Componentes Panel / Panel Components / Composants Paroi



Componentes Panel:

PerfilLongitud
 Terminales.....2
 Portatelas Velcrados....(Long. / n.º portatelas) + 5cm

Componentes Comunes:

Motor.....1
 Soporte Motor.....1
 Transformador.....1
 Soporte Transformador1
 Pletina Aluminio 40x3mm.....Portatelas - 3cm
 Corredoras Portatelas.....4 x portatela
 Topes en L.....1 x portatela
 Topes en T.....1 x portatela
 Soportes.....Ver tabla
 Correa.....Long.perfil +48 dientes
 Blocacuerda.....1
 Tope con Tornillo.....1
 Cinta Velour Hembra 20 mm.....Según Nº Portatelas
 Protector Pletina.....2 x Pletina
 Tapas Portatela.....2 (1 izq. + 1 dcha.)
 x Nº Portatelas



Panel Components:

Track.....Length
 Endcaps.....2
 Fabric Holder.....(Length/n.º fabric holders) + 5cm

Standard Components:

Motor.....1
 Cradle for Motor.....1
 AC Adapter.....1
 Cradle for AC Adapter.....1
 40 x 3 mm. Aluminium Batten...Fabric Holders - 3cm
 Fabric-Holder runners.....4 x Fabric Holder
 L - shaped endstop.....1 x Fabric Holder
 T - shaped endstop.....1 x Fabric Holder
 Brackets.....See table
 Belt-Drive.....Length of the profile + 48 teeth
 Belt-Lock.....1
 Endstop w/screw.....1
 Velour 20 mm loop tape.....Depending on #F.Holders
 Protector Batten.....2 x Batten
 Fabric-holder end caps2 (1 left + 1 right)
 x number of F.Holders



Composants Parois:

Rail.....Largeur
 Bouchons.....2
 Rail Velcro.....(Langeur / no. fabric holders) + 5cm

Composants Communs:

Moteur.....1
 Soporte Motor.....1
 Transformador.....1
 Soporte Transformador.....1
 Bâton Aluminium 40 x 3 mm.....Rail Velcro - 3cm
 Galet porteur de tissus.....4 x Rail Velcro
 Arrêt en L.....1 x Rail Velcro
 Arrêt en T.....1 x Rail Velcro
 Supports.....Voir tableau
 Courroie Dentelée.....Longeur du rail + 48 Dents
 Frein-Courroie.....1
 Vis finale.....1
 Velour femelle.....Selon porte-tissus
 Protecteur Barre de Lestage.....2 x Barre
 Bouchons pour porte-tissus.....2 (1gauche + 1droite)
 x nombre de porte tissus

Accesorios / Accessories / Accessoires

Riel Aluminio Panel Japonés Motorizado 3 Vías
Aluminium track for motorized sliding panel 3 channels / Profil alu pour Parois japonaise motorisé 3 voies

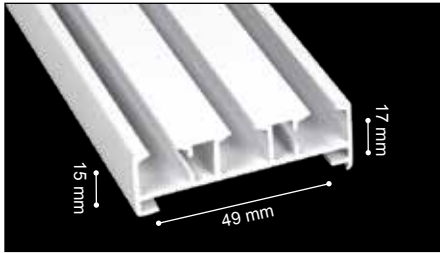

REF	∅				
C.120143BLM		30 m	14,04 €/m	16,15 €/m	570

Riel Aluminio Panel Japonés Motorizado 4 Vías
Aluminium track for motorized sliding panel 4 channels / Profil alu pour Parois japonaise motorisé 4 voies

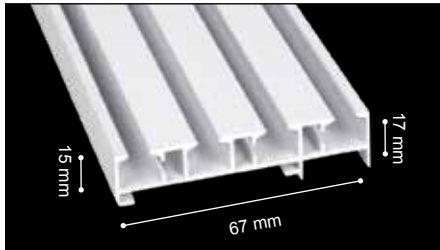

REF	∅				
C.120144BLM		30 m	18,90 €/m	21,74 €/m	570

Riel Aluminio Panel Japonés Motorizado 5 Vías
Aluminium track for motorized sliding panel 5 channels / Profil alu pour Parois japonaise motorisé 5 voies

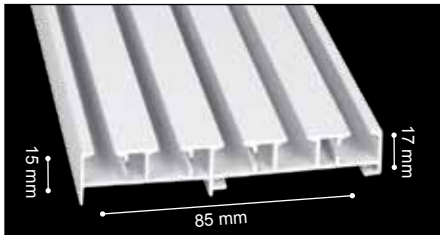

REF	∅				
C.120145BLM		30 m	23,24 €/m	26,73 €/m	570

Perfil Portateclas de Aluminio Velcro
Fabric Holder / Rail Aluminium Velcro



REF	∅				
21626-12001BL		60 m	4,74 €	5,22 €	600

Pletina Aluminio 40x3 mm.
40x3 mm. Aluminium Batten / Bâton Aluminium 40x3 mm.

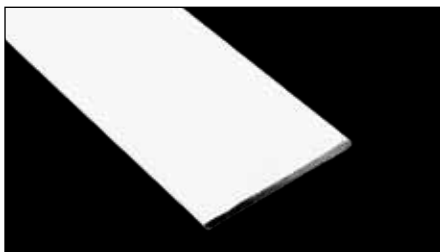

REF	∅				
21626-TR405		40 m	8,92 €/m	10,26 €/m	400

Pletina Contrapeso Metacrilato Transp. (40x5mm)
Transparent acrylic Batten (40x5mm) / Barre de metacrylate transparente (40x5mm)

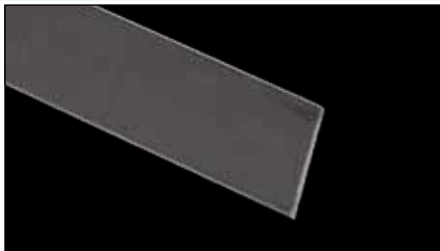

REF	∅				
C.12023TR4000 (236g)		40	8,92 €/m	10,26 €/m	400

Mando a Distancia
Remote Control / Télécommande

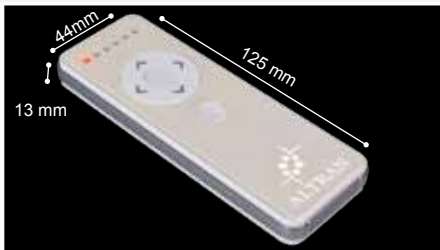

REF	∅				
J.R113		1		51,74 €	

Pulsador Doble
Double Motor Wall Switch / Interrupteur Double

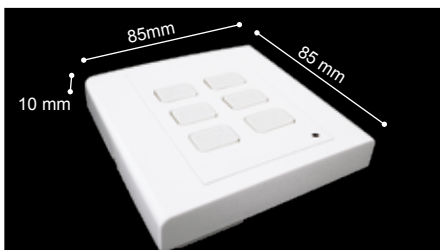

REF	∅				
J.R112		1		31,00 €	

* Se sirve con caja de plástico para instalar el soporte empotrado en la pared. / Supplied with plastic box to insert the bracket into the wall. / Fourni avec boîte en plastic pour insérer le support au mur.

Accesorios / Accessories / Accessoires



Motor
Panel Japonés
Sliding panel motor /
Moteur panneau
japonais

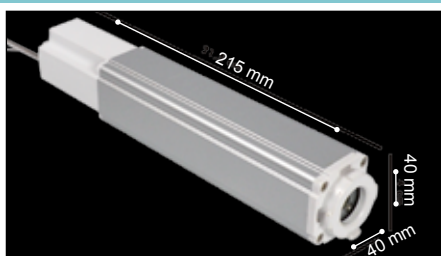

REF	∅	U	€	€	cm
D.1024		1		339,30 €	

Tapa
Panel Japonés
Motorizado
3 vías
3 Channel endcap /
Bouchon finale
3 voies



REF	∅	U	€	€	cm
D.1025		10	1,66 €	1,91 €	

Tapa MOTOR
Panel Japonés
Motorizado
3 vías
3 Channel endcap /
Bouchon finale
3 voies



REF	∅	U	€	€	cm
D.1028		10	41,64 €	47,89 €	

Tapa
Panel Japonés
Motorizado
4 vías
4 Channel endcap /
Bouchon finale
4 voies



REF	∅	U	€	€	cm
D.1026		10	2,78 €	3,20 €	

Tapa MOTOR
Panel Japonés
Motorizado
4 vías
4 Channel endcap/
Bouchon finale
4 voies



REF	∅	U	€	€	cm
D.1029		10	41,96 €	48,25 €	

Tapa Panel
Japonés
Motorizado 5 vías
5 Channel
endcap /
Bouchon finale
5 voies



REF	∅	U	€	€	cm
D.1027		10	3,24 €	3,73 €	

Tapa MOTOR
Panel Japonés
Motorizado
5 vías
5 Channel endcap /
Bouchon finale
5 voies



REF	∅	U	€	€	cm
D.1030		10	42,96 €	49,40 €	

Soporte
Panel Japonés
Motorizado
Motorized sliding
panel bracket /
Support
Parois Japonaise
Motorisé

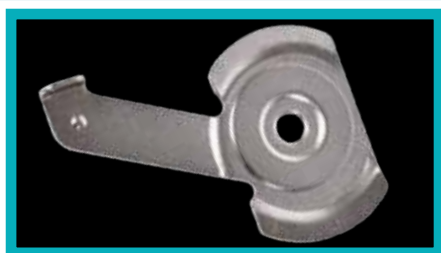

REF	∅	U	€	€	cm
D.1031		25	1,86 €	2,14 €	

* Soporte incluido en el kit /
Bracket supplied in the kit / Support fourni dans le kit.

PANEL JAPONÉS MOTORIZADO

Accesorios / Accessories / Accessoires



Blocacuerda de la Correa Panel Japonés Motorizado

Lock for motorized Sliding Panel belt / Frein pour corroie Parois Japonaise Motorisé



REF	∅				
D.1032		25	0,54 €	0,62 €	

Soporte Motor Panel Japonés Motorizado

Holder for sliding panel motor / Support pour moteur parois japonais

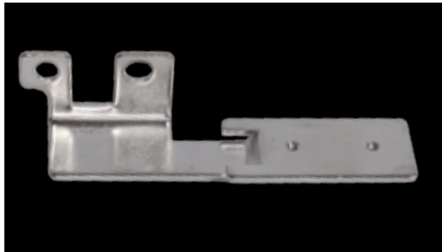

REF	∅				
D.1034		10	2,04 €	2,35 €	

Correa Panel Japonés Motorizado

Drive belt for motorized sliding panel / Corroie parois japonais motorisé

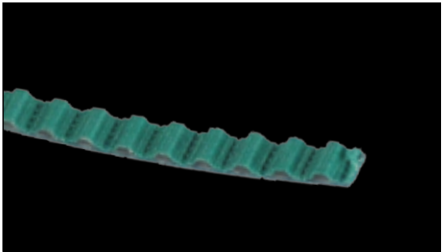

REF	∅				
D.1035		20	9,26 €	10,65 €	

Correderas Portatelas

Fabric-Holder Runner / Glisseur Porteur de Tissus



REF	∅				
D.1033		10	0,54 €	0,62 €	

Tope T Panel Japonés Motorizado

T-shaped Enstop Motorized system / Arrêt en T Motorisé



REF	∅				
D.1036		20	0,54 €	0,62 €	

Tope L Panel Japonés Motorizado

L-shaped Enstop Motorized System / Arrêt en L Motorisé

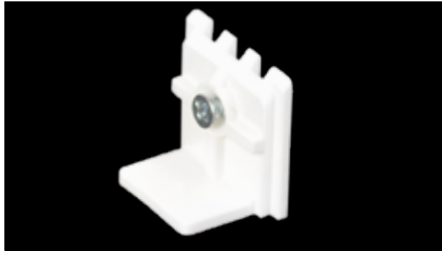

REF	∅				
D.1037		50	0,54 €	0,62 €	

Cinta Velcro Hembra Velour 20 mm

Touch&Close Fastener Tape (Loop Section) / Velcro femelle velour

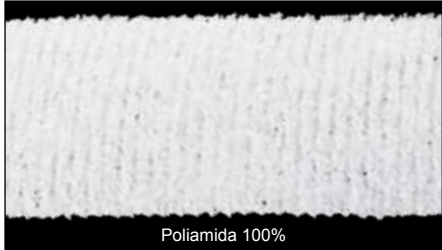

REF	COLOR		rollo (m) roll (m)	Precio/m	
30175-11001	blanco/white	rígido	50 m	0,40 €/m	20 mm
30175-22001	blanco/white	suave	50 m	0,44 €/m	20 mm
30175-24001	blanco/white	superpes	50 m	0,52 €/m	20 mm

Protector de Pletina 3x40

Protector Batten 3x40 / Protecteur Barre de lestage 3x40



REF	∅				
21626-TP		100	0,20 €	0,22 €	

Accesorios / Accessories / Accessoires



Transformador
Adaptor /
Transformateur



REF	∅	U	€	€	cm
D.1020		1		51,06 €	

Soporte para
transformador
Adaptor Bracket /
Support
Transformateur



REF	∅	U	€	€	cm
D.1021		1		5,68 €	

CORTINAS ENROLLABLES

Ponemos a disposición de nuestros clientes una amplia gama de tejidos técnicos para cortinas enrollables. Solicite catálogos y tarifas.





Accesorios de Confección • Varios

confection accessories • miscellaneous /
accessoires de confection • divers

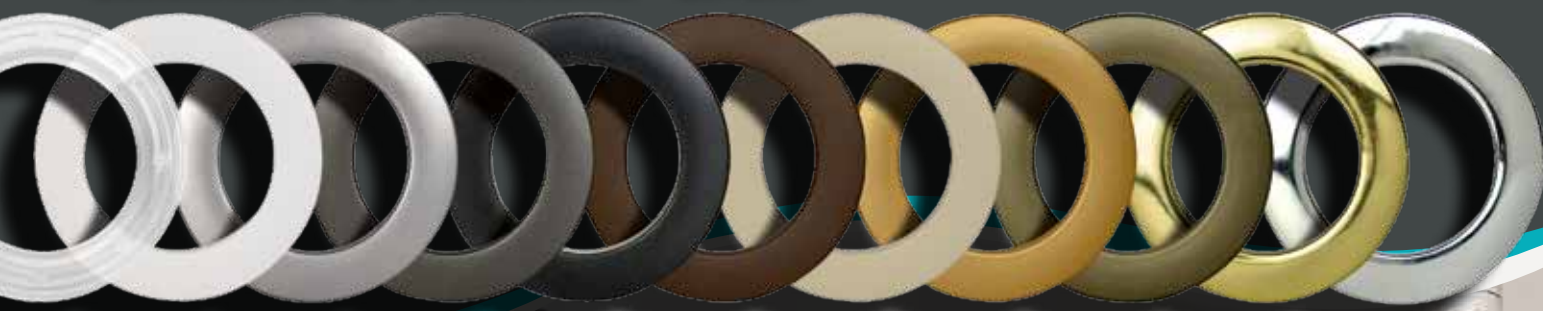

Marvent

SOLUCIONES PARA DECORAR VENTANAS



Marvent

SOLUCIONES PARA DECORAR VENTANAS



Garfios / Hooks / Crochets

Caja de ganchos de plástico EXTRA FUERTES



REF	∅	U	€	1	cm
45472-P		1000	27,85 €		

Caja de 1000 ganchos

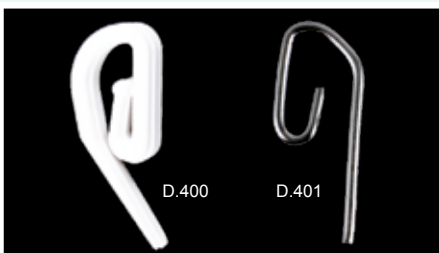

REF	∅	U	€	1	cm
45472-PE (D400)		1000	15,40 €		
45472-FR (D401)		1000	12,60 €		

Caja de 100 ganchos regulable de plástico



REF	∅	U	€	1	cm
45472-GR		100	15,46 €		

Gancho Ancla Caja

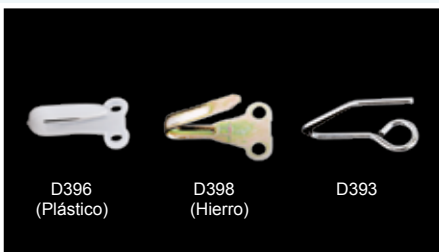

REF	∅	U	€	1	cm
20603-D396		1000	26,72 €		
20603-D398		500	50,92 €		
20603-D393		1000	52,88 €		

Gancho Pincho Caja 500 u

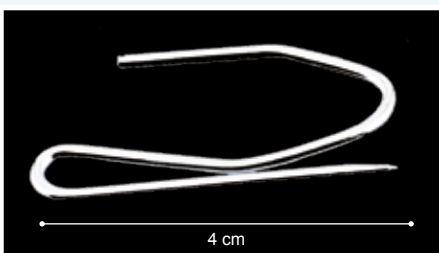

REF	∅	U	€	1	cm
45472-PI		500	15,46 €		

Caja 25 Balancines

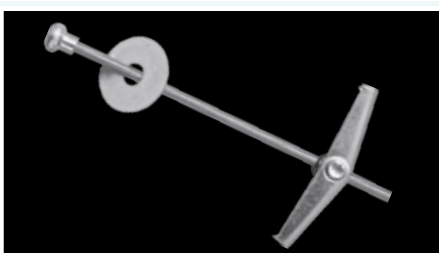

REF	∅	U	€	1	cm
90400-1421		25	38,50 €		

Garfio frente Garfio techo Bolsas de 100 ud.

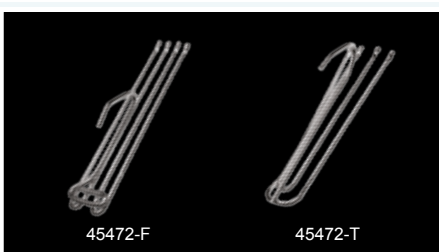

REF	∅	U	€	1	cm
45472-T		100	7,80 €		
45472-F		100	7,80 €		

Garfios especiales Bolsas de 100 ud.



REF	∅	U	€	1	cm
45472-I		100	8,00 €		
45472-D		100	8,00 €		

Cintas Automáticas / Automatic Tapes / Rubans Automatique



REF	Descripción Description Description	Ancho Width Largeur	Bolsas Bags Sacs	Nº Cord.	Composición Composition Composition	Color Color Couleur	Metros /caja	Precio /m
30178-0452B2CLA01100	Automática 45 mm.	45 mm.	2	2	poliéster	blanco	100	0,48 €
30178-0452B2CLA02100	Automática 45 mm.	45 mm.	2	2	poliéster	beige	100	0,50 €
30177-0652B2CLA01150	Automática 65 mm.	65 mm.	2	2	poliéster	blanco	150	0,56 €
30177-0652B2CLA02150	Automática 65 mm.	65 mm.	2	2	poliéster	beige	150	0,57 €
30177-0652B2CPP01150	Automática 65 mm.	65 mm.	2	2	polipropileno	blanco	150	0,50 €
30177-0652B2CPP02150	Automática 65 mm.	65 mm.	2	2	polipropileno	beige	150	0,52 €
30177-0653B2CPP01150	Automática 65 mm.	65 mm.	3	2	polipropileno	blanco	150	0,50 €
30177-0653B2CPP02150	Automática 65 mm.	65 mm.	3	2	polipropileno	beige	150	0,52 €
30177-0705B2CLA01150	Automática 70 mm.	70 mm.	5	2	poliéster	blanco	150	0,62 €
30177-0705B2CLA02150	Automática 70 mm.	70 mm.	5	2	poliéster	beige	150	0,64 €
30177-0705B2CPP01150	Automática 70 mm.	70 mm.	5	2	polipropileno	blanco	150	0,54 €
30177-0705B2CPP02150	Automática 70 mm.	70 mm.	5	2	polipropileno	beige	150	0,58 €
30177-0755B3CLA01150	Automática 75 mm.	75 mm.	5	3	poliéster	blanco	150	0,72 €
30177-0755B3CLA02150	Automática 75 mm.	75 mm.	5	3	poliéster	beige	150	0,74 €
30177-0756B2CLA03150	Automática 75 mm.	75 mm.	6	2	poliéster	transparente	150	0,84 €
30178-0852B3CLA01150	Automática 85 mm.	85 mm.	2	3	poliéster	blanco	150	0,86 €
30178-0852B3CLA02150	Automática 85 mm.	85 mm.	2	3	poliéster	beige	150	0,88 €
30178-1205B4CLA01100	Automática 120 mm.	120 mm.	5	4	poliéster	blanco	100	1,10 €
30178-1205B4CLA02100	Automática 120 mm.	120 mm.	5	4	poliéster	beige	100	1,12 €
30178-1205B4CLA03100	Automática 120 mm.	120 mm.	5	4	poliéster	transparente	100	1,16 €
30170-1604B5CLA01050	Automática 160 mm.	160 mm.	4	5	poliéster	blanco	50	3,10 €
30176-17014B4CLA0150	Automática 170 mm.	170 mm.	14	4	poliéster	blanco	50	1,90 €
30176-17014B4CLA3050	Automática 170 mm.	170 mm.	14	4	poliéster	transparente	50	2,40 €

Cintas Encrestadoras



REF	Descripción Description Description	Ancho Width Largeur	Bolsas Bags Sacs	Nº Cord.	Composición Composition Composition	Color Color Couleur	Metros /caja	Precio /m
30178-0852B3CEA01150	Encrestadora 85 mm.	85 mm.	2	3	poliéster	blanco	150	0,86 €
30178-0852B3CEA02150	Encrestadora 85 mm.	85 mm.	2	3	poliéster	beige	150	0,88 €
30178-1205B4CAE01100	Encrestadora 120 mm.	120 mm.	5	4	poliéster	blanco	100	1,12 €
30178-1205B4CAE02100	Encrestadora 120 mm.	120 mm.	5	4	poliéster	beige	100	1,14 €
30178-1205B4CAE03150	Encrestadora 120 mm.	120 mm.	5	4	poliéster	transparente	100	1,16 €
30177-0652B2CPP02150	Encrestadora 120 mm. 1 pliegue	120 mm.	5	4	poliéster	transparente	100	1,16 €

Triple pliegue



REF	Descripción Description Description	Ancho Width Largeur	Bolsas Bags Sacs	Nº Cord.	Composición Composition Composition	Color Color Couleur	Metros /caja	Precio /m
30178-0755B3CTP01150	triple pliegue 75	75 mm.	5	3	poliéster	blanco	150	0,84 €
30178-0755B3CTP02100	triple pliegue 75	75 mm.	5	3	poliéster	beige	150	0,86 €
30178-1205B4CTP01100	triple pliegue 120	120 mm.	5	4	poliéster	blanco	100	1,12 €
30178-1205B4CTP02100	triple pliegue 120	120 mm.	5	4	poliéster	beige	100	1,14 €
30178-1205B4CTP03100	triple pliegue 120	120 mm.	5	4	poliéster	transparente	100	1,16 €
30176-17012B4CVI0150	vipliss 170	170 mm.	12	4	poliéster	blanco	50	2,40 €

Nido de abeja



REF	Descripción Description Description	Ancho Width Largeur	Bolsas Bags Sacs	Nº Cord.	Composición Composition Composition	Color Color Couleur	Metros /caja	Precio /m
30178-0852B3CNB01150	nido de abeja	85 mm.	2	3	poliéster	blanco	150	0,80 €
30178-0852B3CNB02150	nido de abeja	85 mm.	2	3	poliéster	beige	150	0,82 €
30176-17012B4CNA0350	nido de abeja	170 mm.	12	4	poliéster	transparente	50	2,40 €
30178-0852B3CTR01150	triangular	85 mm.	2	3	poliéster	blanco	150	0,80 €
30178-0852B3CTR02150	triangular	85 mm.	2	3	poliéster	beige	150	0,82 €

Automática V doble pliegue

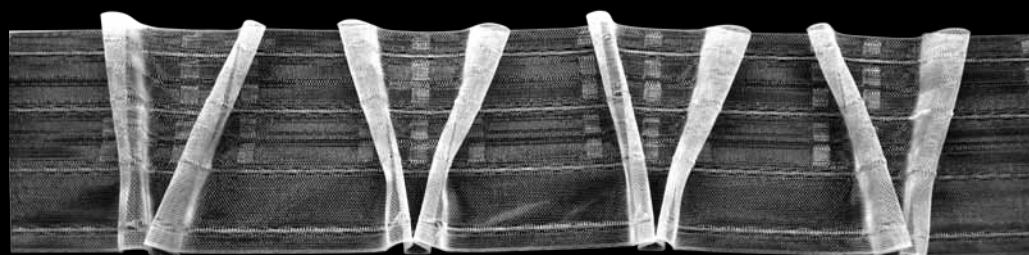

REF	Descripción Description Description	Ancho Width Largeur	Bolsas Bags Sacs	Nº Cord.	Composición Composition Composition	Color Color Couleur	Metros /caja	Precio /m
30178-1205B4CPV03100	autonom. 120 mm. pliegue V transp.	120 mm.	5	4	poliéster	transpar.	100	1,20 €

Tablas

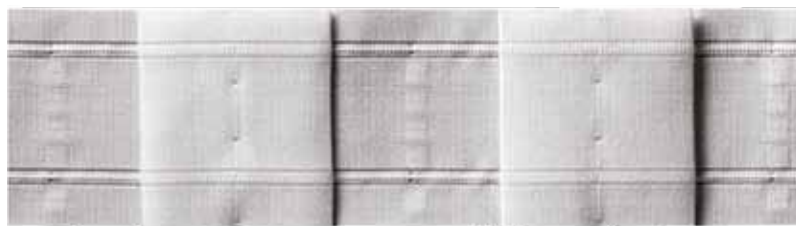

REF	Descripción Description	Ancho Width Largeur	Bolsas Bags Sacs	Nº Cord.	Composición Composition	Color Color Couleur	Metros /caja	Precio /m
30177-0755B2C2001150	tablas 2x1	75 mm.	5	2	poliéster	blanco	150	0,76 €
30177-0755B2C2002150	tablas 2x1	75 mm.	5	2	poliéster	beige	150	0,78 €
30178-0755B2C2003150	tablas 2x1	75 mm.	5	2	poliéster	transparente	150	0,86 €
30177-0755B2C2301150	tablas 2,30x1	75 mm.	5	2	poliéster	blanco	150	0,78 €
30177-0755B2C2302150	tablas 2,30x1	75 mm.	5	2	poliéster	beige	150	0,76 €

Multibolsa



REF	Descripción Description	Ancho Width Largeur	Bolsas Bags Sacs	Nº Cord.	Composición Composition	Color Color Couleur	Metros /caja	Precio /m
30177-0900B0CLA01150	multibolsa	90 mm.			poliéster	blanco	150	0,60 €
30177-0900B0CLA02150	multibolsa	90 mm.			poliéster	beige	150	0,62 €
30177-0900B0CPP01150	multibolsa	90 mm.			polipropileno	blanco	150	0,58 €
30177-0900B0CPP02150	multibolsa	90 mm.			polipropileno	beige	150	0,60 €

Armadora



Armadora

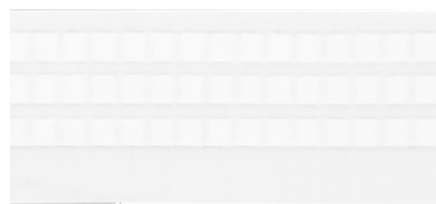

Armadora con bolsas

REF	Descripción Description	Ancho Width Largeur	Bolsas Bags Sacs	Nº Cord.	Composición Composition	Color Color Couleur	Metros /caja	Precio /m
30178-0700B0CLA01200	armadora sin bolsas	70 mm.			poliéster	blanco	200	0,50 €
30178-0700B0CLA02200	armadora sin bolsas	70 mm.			poliéster	beige	200	0,52 €
30178-0800B0CLA01200	armadora sin bolsas	80 mm.			poliéster	blanco	200	0,52 €
30178-0800B0CLA02200	armadora sin bolsas	80 mm.			poliéster	beige	200	0,56 €
30178-0900B0CLA01200	armadora sin bolsas	90 mm.			poliéster	blanco	200	0,62 €
30178-0900B0CLA02200	armadora sin bolsas	90 mm.			poliéster	beige	200	0,64 €
30178-0900B0CLA03200	armadora sin bolsas	90 mm.			poliéster	transparente	200	0,68 €
30178-0704B0CLA01200	armadora con bolsas	70 mm.	4		poliéster	blanco	200	0,74 €
30178-1206B0CLA01100	armadora con bolsas	120 mm.	6		poliéster	blanco	100	1,10 €
30178-1206B0CLA02100	armadora con bolsas	120 mm.	6		poliéster	beige	100	1,12 €
30178-1206B0CLA03100	armadora con bolsas	120 mm.	6		poliéster	transparente	100	1,14 €

GrinZefisso 100



REF	Descripción Description Description	Ancho Width Largeur	Bolsas Bags Sacs	Nº Cord.	Composición Composition Composition	Color Color Couleur	Metros /caja	Precio /m
30178-1004B4CLA01100	grinZefisso	100 mm.	4	4	poliéster	blanco	100	0,90 €
30178-1004B4CLA02100	grinZefisso	100 mm.	4	4	poliéster	beige	100	0,92 €

Doble pliegue 120

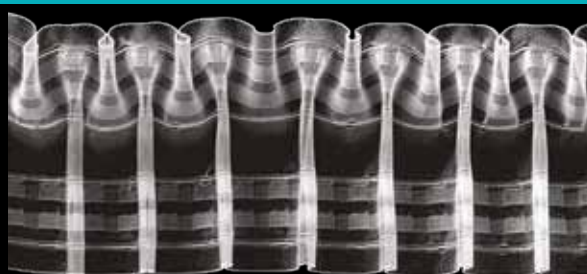

REF	Descripción Description Description	Ancho Width Largeur	Bolsas Bags Sacs	Nº Cord.	Composición Composition Composition	Color Color Couleur	Metros /caja	Precio /m
30178-1205B4CDP03100	doble pliegue	120 mm.	5	4	poliéster	transpar.	100	1,16 €

Bouilloné 120



REF	Descripción Description Description	Ancho Width Largeur	Bolsas Bags Sacs	Nº Cord.	Composición Composition Composition	Color Color Couleur	Metros /caja	Precio /m
30176-1204B2CLA03100	bouilloné	120 mm.	4	2	poliéster	transpar.	100	1,48 €

Cintas con velcro



REF	Descripción Description Description	Ancho Width Largeur	Bolsas Bags Sacs	Nº Cord.	Composición Composition Composition	Color Color Couleur	Metros /caja	Precio /m
30176-0402B2CLA01050	automática velcrada	40 mm.	2	2	poliéster	blanco	50	0,92 €
30176-0753B3CLA01050	automática velcrada	75 mm.	3	3	poliéster	blanco	50	1,56 €

Cintas para barras



REF	Descripción Description	Ancho Width Largeur	Bolsas Bags Sacs	Para barra	Composición Composition	Color Color Couleur	Metros /caja	Precio /m
30178-1001B0CLA03100	cinta vial con hilos	100 mm.		30 mm.	poliéster	transparente	100	1,08 €
30178-1001B19LA03100	cinta vial con hilos	100 mm.		19 mm.	poliéster	transparente	100	1,06 €
30178-1001B0TRA03050	cinta vial con trabillas	100 mm.		30 mm.	poliéster	transparente	50	2,84 €
30178-100119TRA03050	cinta vial con trabillas	100 mm.		19 mm.	poliéster	transparente	50	2,50 €
30178-1001B2CPH03100	automático vial c/pasahilos	100 mm.		30 mm.	poliéster	transparente	100	1,18 €

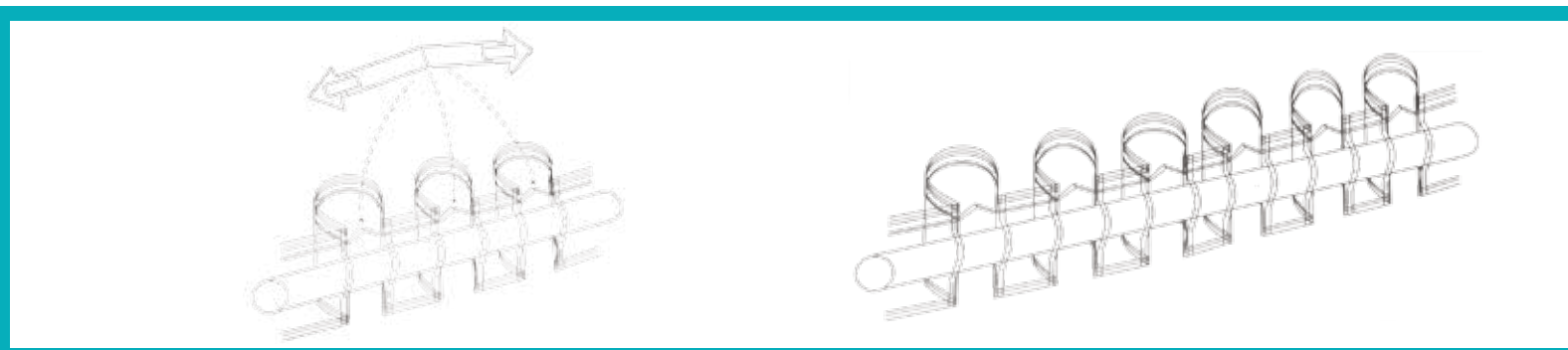

REF	Descripción Description	Ancho Width Largeur	Bolsas Bags Sacs	Para barra	Composición Composition	Color Color Couleur	Metros /caja	Precio /m
30178-100BP0CLATR050	cinta vial c/trabilla bucle perfecto	100 mm.		30 mm.	poliéster	transparente	50	3,30 €
30178-100	onduladores (100 ud.)	99 mm.				blanco	1	22,60 €

Cintas para ollaos



REF	Descripción Description	Ancho Width Largeur	Bolsas Bags Sacs	Ollaos	Composición Composition	Color Color Couleur	Metros /caja	Precio /m
45335-42010000000050	cinta ollaos 42 mm.	80 mm.		6/metro	poliéster	blanco	50	2,24 €
45335-42030000000050	cinta ollaos 42 mm.	80 mm.		6/metro	poliéster	transparente	50	3,58 €
45335-O	embellecedor ollaos 42 mm.	42 mm.				oro	100	0,76 €
45335-N	embellecedor ollaos 42 mm.	42 mm.				negro	100	0,76 €
45335-PM	embellecedor ollaos 42 mm.	42 mm.				plata	100	0,76 €
45335-PB	embellecedor ollaos 42 mm.	42 mm.				acero	100	0,76 €

Cintas con ollaos



Cenefa decorativa



Cinta sabicort decorativa

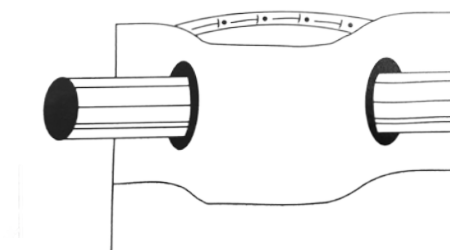

REF	Descripción Description Description	Ancho Width Largeur	Composición Composition Composition	Color Color Couleur	Metros /caja	Precio /m
30178-1000B0CCE01025	cenefa decorativa con ollaos	110 mm.	poliéster	blanco	25	11,84 €
30178-1000B0CCE02025	cenefa decorativa con ollaos	110 mm.	poliéster	marfil	25	11,84 €
30178-1000B0CCE71025	cenefa decorativa con ollaos	110 mm.	poliéster	azul	25	11,84 €
30178-1000B0CCE72025	cenefa decorativa con ollaos	110 mm.	poliéster	lino	25	11,84 €
30178-1000B0CCE73025	cenefa decorativa con ollaos	110 mm.	poliéster	negro	25	11,84 €
30178-1000B0CCE77025	cenefa decorativa con ollaos	110 mm.	poliéster	chocolate	25	11,84 €
30178-1000B0CCE74025	cenefa decorativa con ollaos	110 mm.	poliéster	malva	25	11,84 €
30178-1000B0CCE75025	cenefa decorativa con ollaos	110 mm.	poliéster	granate	25	11,84 €
30178-1000B0CCE76025	cenefa decorativa con ollaos	110 mm.	poliéster	gris	25	11,84 €
30178-1000B0CSA01025	cinta sabicort decorativa enganches de lengüeta	100 mm.	poliéster	blanco	25	5,08 €
30178-1000B0CSA02025	cinta sabicort decorativa enganches de lengüeta	100 mm.	poliéster	beige	25	5,08 €
30178-1000B0CSA71025	cinta sabicort decorativa enganches de lengüeta	100 mm.	poliéster	azul	25	5,08 €
30178-1000B0CSA72025	cinta sabicort decorativa enganches de lengüeta	100 mm.	poliéster	verde	25	5,08 €
30178-1000B0CSA73025	cinta sabicort decorativa enganches de lengüeta	100 mm.	poliéster	negro	25	5,08 €
30178-1000B0CSA74025	cinta sabicort decorativa enganches de lengüeta	100 mm.	poliéster	marrón	25	5,08 €
30178-1000B0CSA75025	cinta sabicort decorativa enganches de lengüeta	100 mm.	poliéster	granate	25	5,08 €

Cintas para onda perfecta

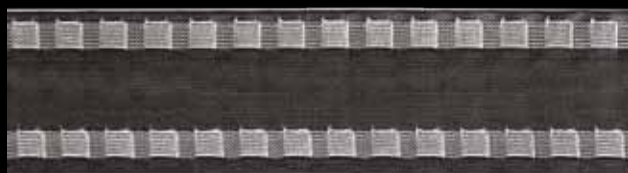

Cinta armadora Onda Perfecta

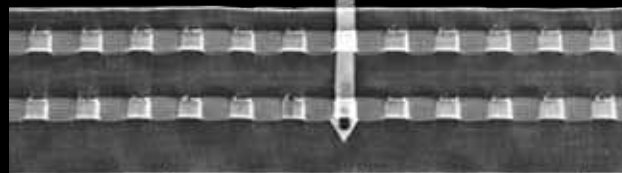

Cinta armadora Onda Confort para onduladores

REF	Descripción Description Description	Ancho Width Largeur	Bolsas Bags Sacs	Composición Composition Composition	Color Color Couleur	Metros /caja	Precio /m
30177-0752B0PLA03100	cinta armadora onda perfecta	75 mm.	2	poliéster	transparente	150	1,16 €
30177-0752B0CLA03150	cinta onda confort (onduladores)	75 mm.	2	poliéster	transparente	150	0,98 €
30178-100	onduladores (100 ud.)	99 mm.			blanco	1	22,60 €

Información General / General Information / Informations Générales

Cinta adaptable para obtener el resultado Onda Confort tanto en Rieles como en Barras.

Adaptable tape to get the Confort wave result in tracks and poles / Ruban adaptatif pour réussir l'Onde Confort dans rails et tringles.

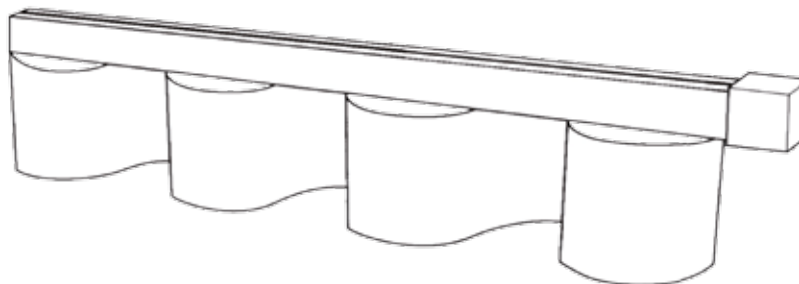

Onda Perfecta vs Onda Confort.

En la Onda Perfecta, la Onda siempre será igual porque la ondulación se hace gracias a las correderas, mientras que la Onda Confort depende del espacio entre onduladores. En la Onda Perfecta la Onda Frontal y Trasera son Idénticas. En la Onda Confort la Onda Trasera quedará Plana si la cortina está extendida. Usted decide el rapport, la cantidad de tela que quiere gastar y el tipo de onda usando los onduladores.

With the perfect wave tape, the waves have all the same size since the waving is a result of the runners space, whereas the size of Confort wave depends on the space marked by the arrows. In the perfect wave system, the front and the back waves are identical. In the confort wave system, the back wave will remain flat when the curtain is fully extended. You decide the rapport, the quantity of fabric that you need and the type of wave you want to get by using the wavings.

Dans le cas du ruban onde parfaite, les ondes ont toutes le même mesure prévue en raison des glisseurs, tandis que le ruban onde confort dépend de l'espace marqué par les fleches. Dans le système onde parfaite, les ondes sûr devant et derrière sont identiques. Dans le système d'onde Confort, l'onde sûr devant restera plate avec le rideau déplié. Vous decidez le rapport, la quantité de tissu et le type d'onde que vous voulez créer avec l'utilisation des ondulateurs.

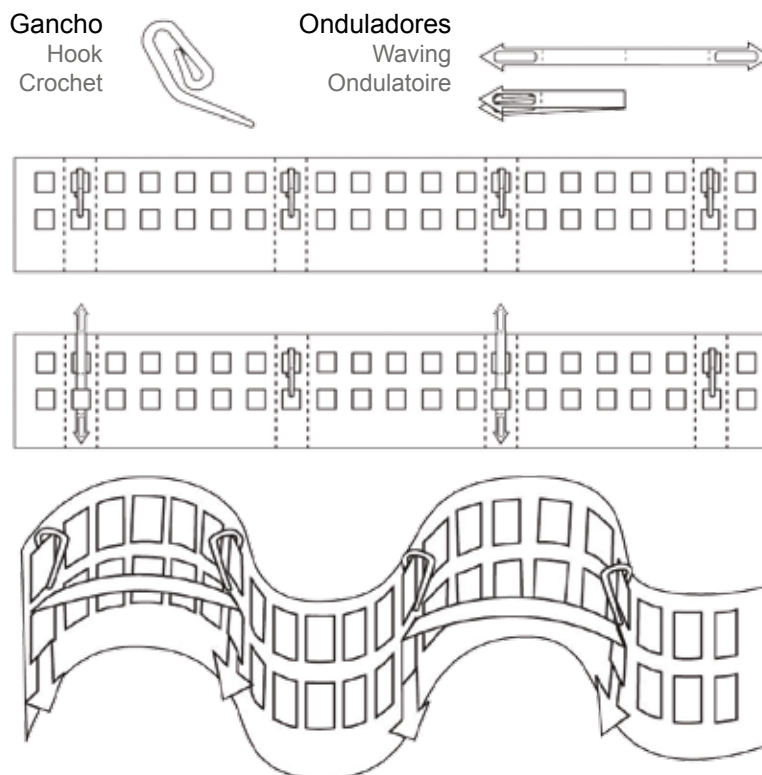

Cintas estor

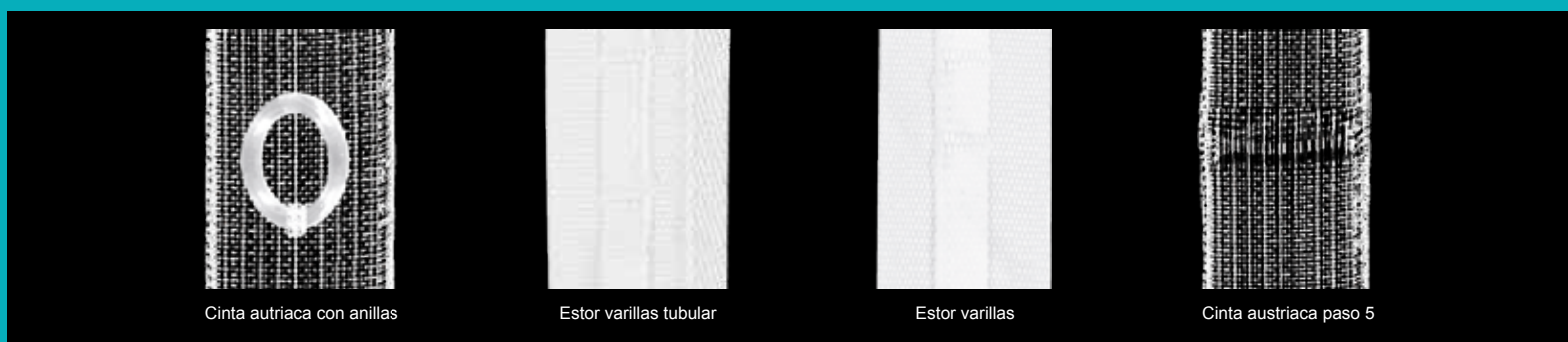

REF	Descripción Description Description	Ancho Width Largeur	Bolsas Bags Sacs	Composición Composition Composition	Color Color Couleur	Metros /caja	Precio /m
30178-0160BOCLA01300	cinta estor varilla	16 mm.		poliéster	blanco	300	0,32 €
30178-0160BOCLA02300	cinta estor varilla	16 mm.		poliéster	beige	300	0,34 €
30177-0160BOCLA03300	cinta estor varilla	16 mm.		poliéster	transparente	300	0,40 €
30178-016TA0CLA01300	cinta estor varilla tubular	16 mm.		poliéster	blanco	300	0,52 €
30178-016TA0CLA02300	cinta estor varilla tubular	16 mm.		poliéster	beige	300	0,54 €
30178-016TA0CLA03300	cinta estor varilla tubular	16 mm.		poliéster	transparente	300	0,56 €
30178-B2000P5LA03300	cinta austriaca paso 5 cm.	16 mm.	pasadores cada 5 cm	poliéster	transparente	300	0,50 €
30177-0161A0CLA03150	cinta austriaca c/anillas	16 mm.	anillas cada 15 cm	poliéster	transparente	300	1,06 €
30178-0100BOC1503120	cinta austriaca c/anillas (un solo cosido)	16 mm.	anillas cada 15 cm (un solo cosido)	poliéster	transparente	300	1,06 €

Velcro

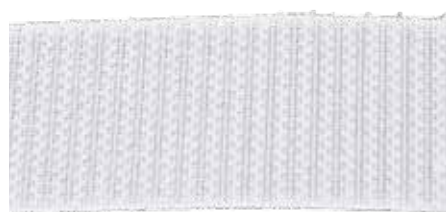

Velcro macho



Macho adhesivo



Velcro hembra

REF	Descripción Description Description	Ancho Width Largeur	Composición Composition Composition	Color Color Couleur	Metros /caja	Precio /m
30175-11001	velcro hembra	20 mm.	rígida	blanco	50	0,40 €
30175-12001	velcro hembra	20 mm.	rígida	negro	50	0,44 €
30175-22001	velcro hembra	20 mm.	suave	blanco	50	0,48 €
30175-24001	velcro hembra	20 mm.	super pesada	blanco	50	0,52 €
30175-50001	velcro hembra	50 mm.	rígida	blanco	50	0,82 €
30175-50004	velcro hembra	50 mm.	rígida	negro	50	0,86 €
30174-ADH20	velcro hembra adhesiva	20 mm.	adhesiva	blanco	50	0,82 €
30174-ADH20N	velcro hembra adhesiva	20 mm.	adhesiva	negro	50	0,88 €
30174-ADH50B	velcro hembra adhesiva	50 mm.	adhesiva	blanco	50	2,08 €
30174-ADH50N	velcro hembra adhesiva	50 mm.	adhesiva	negro	50	2,14 €
30175-11002	velcro macho	20 mm.		blanco	50	0,40 €
30175-12002	velcro macho	20 mm.		negro	50	0,44 €
30175-50002	velcro macho	50 mm.		blanco	50	0,82 €
30175-50003	velcro macho	50 mm.		negro	50	0,86 €
30174-VESB	macho adhesivo	20 mm.	adhesiva	blanco	50	0,82 €
30174-ADM20N	macho adhesivo	20 mm.	adhesiva	negro	50	0,88 €
30174-ADM50B	macho adhesivo	50 mm.	adhesiva	blanco	50	2,08 €
30174-ADM50N	macho adhesivo	50 mm.	adhesiva	negro	50	2,14 €

Cordones vivos, plomo y galón estor

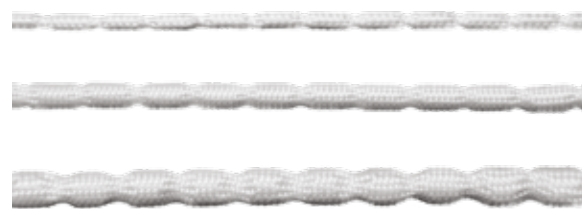

Blanco
White
Blanc

REF	Descripción Description Description	Ancho Width Largeur	Bolsas Bags Sacs	Composición Composition Composition	Color Color Couleur	Metros /caja	Precio /m
30178-90000090501300	cordón vivo trenzado	4 mm.		poliéster	blanco	400	0,20 €
30178-90000060501300	cordón vivo trenzado	5 mm.		poliéster	blanco	300	0,24 €
30178-900000890501200	cordón vivo trenzado	6 mm.		poliéster	blanco	200	0,28 €
90606-35	cordón plomo	35 g.		poliéster	blanco	50	0,64 €
90606-50	cordón plomo	50 g.		poliéster	blanco	50	0,80 €
90606-70	cordón plomo	70 g.		poliéster	blanco	50	1,30 €
30177-0060B0CLA01300	galón estor	6 mm.		poliéster	blanco	300	0,32 €

RELLENOS COJÍN / FORROS CORTINAS

Rellenos de cojín

Rellenos de cojín de fibra hueca siliconada "SIN VACÍO"



REF	medida	embalaje	€	€
70801-3050S	30x50	30	3,20 €	
70801-4040S	40x40	30	3,20 €	
70801-4060S	40x60	14	4,84 €	
70801-4545S	45x45	24	3,78 €	
70801-5050S	50x50	18	4,84 €	
70801-5070S	50x70	10	6,68 €	
70801-6060S	60x60	10	6,68 €	

Rellenos de cojín de fibra hueca siliconada "AL VACÍO"



REF	medida	embalaje	€	€
70801-3050	30x50	22	3,70 €	4,32 €
70801-4040	40x40	22	3,70 €	4,32 €
70801-4060	40x60	10	5,42 €	6,50 €
70801-4545	45x45	18	4,50 €	5,40 €
70801-5050	50x50	16	5,42 €	6,50 €
70801-5070	50x70	10	7,60 €	9,12 €
70801-6060	60x60	10	7,60 €	9,12 €

Forros para cortinas

Forro 27 pasadas de 2,80 m. ancho

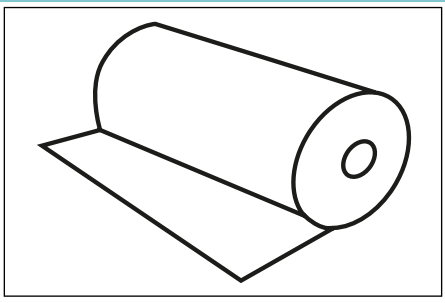

REF	rollo (m) roll (m)	€	COLOR	mm
60180-302701	30 m	5,90 €/m	blanco	
60180-302702	30 m	5,90 €/m	beige	

Forro + guata 80 y 150 g.
Cosido de 2,70 m.

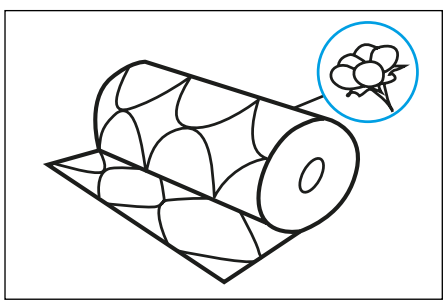

REF	rollo (m) roll (m)	€	COLOR	mm
61180-C080270	25 m	21,60 €/m	marfil	
61180-C150280	25 m	28,40 €/m	marfil	



FUNDAS DE COJÍN

Ponemos a su disposición una amplia gama de fundas de cojín para darle un toque cálido y confortable a su hogar.



Cintas de ojete con embellecedor de 42 mm. (manuales)

Cinta ollao

∅ 42 mm



Polipropileno 100%

REF	COLOR	rollo (m) roll (m)	€
45335-42010000000050	blanco	50	2,24 €
45335-42030000000050	transpar.	50	3,58 €

Ollao embellecedor
Oro



REF	BARRA POLE TRINGLE	U	€	cm
45335-O	30	100	0,76 €	

Ollao embellecedor
Negro



REF	BARRA POLE TRINGLE	U	€	cm
45335-N	30	100	0,76 €	

Ollao embellecedor
Plata Brillo



REF	BARRA POLE TRINGLE	U	€	cm
45335-PB	30	100	0,76 €	

Ollao embellecedor
Plata Mate



REF	BARRA POLE TRINGLE	U	€	cm
45335-PM	30	100	0,76 €	

Ollao embellecedor
Oro Mate



REF	BARRA POLE TRINGLE	U	€	cm
45335-OM	30	100	0,76 €	

Ollao embellecedor
Blanco



REF	BARRA POLE TRINGLE	U	€	cm
45335-B	30	100	0,76 €	

Ollao embellecedor
Bronce



REF	BARRA POLE TRINGLE	U	€	cm
45335-BR	30	100	0,76 €	

Ollao embellecedor
Cobre



REF	BARRA POLE TRINGLE	U	€	cm
45335-C	30	100	0,76 €	

Ollaos Policarbonato / Polycarbonate Eyelets / Oeillets Polycarbonate - 100%

OLLAOS DE POLICARBONATO PARA BARRAS DE 19 y 30 mm /
 POLYCARBONATE EYELETS FOR 19 & 30 mm POLE /
 OEILLETS POLYCARBONATE POUR TRINGLE 19 et 30 mm

***Es necesario prensa**

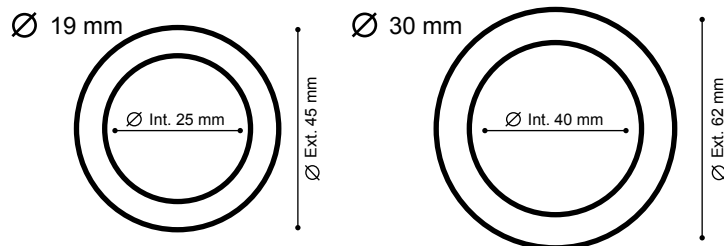

Color	REF	Ø BARRA POLE TRINGLE	U	€	€	cm
Ollao Transparente	45335-1201	19	50	0,44 €		
	45335-1101	30	50	0,74 €		
Ollao Blanco	45335-1202	19	50	0,44 €		
	45335-1102	30	50	0,74 €		
Ollao Negro	45335-1203	19	50	0,44 €		
	45335-1103	30	50	0,74 €		
Ollao Rojo	45335-1204	19	50	0,44 €		
	45335-1104	30	50	0,74 €		
Ollao Amarillo	45335-1205	19	50	0,44 €		
	45335-1105	30	50	0,74 €		
Ollao Azul	45335-1206	19	50	0,44 €		
	45335-1106	30	50	0,74 €		
Ollao Niquel Mate	45335-1207	19	50	0,44 €		
	45335-1107	30	50	0,74 €		

*Hasta fin de existencias / Until the end of stocks / Jusqu'a la fin de stocks

*Hasta fin de existencias / Until the end of stocks / Jusqu'a la fin de stocks

*Hasta fin de existencias / Until the end of stocks / Jusqu'a la fin de stocks

Ollaos Policarbonato / Polycarbonate Eyelets / Oeillets Polycarbonate - 100%

Ollao Latón Mate



REF	Ø BARRA POLE TRINGLE	U	€	€	cm
45335-1208	19	50	0,44 €		
45335-1108	30	50	0,74 €		

Ollao pino

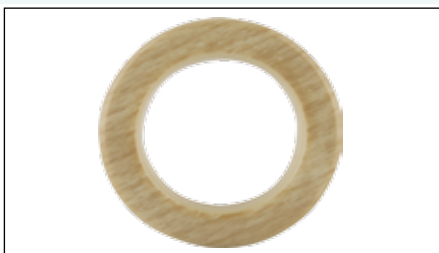

REF	Ø BARRA POLE TRINGLE	U	€	€	cm
45335-1209	19	50	0,62 €		
45335-1109	30	50	0,92 €		

*Hasta fin de existencias / Until the end of stocks / Jusqu'a la fin de stocks

Ollao roble



REF	Ø BARRA POLE TRINGLE	U	€	€	cm
45335-1210	19	50	0,62 €		
45335-1110	30	50	0,92 €		

*Hasta fin de existencias / Until the end of stocks / Jusqu'a la fin de stocks

Ollao óxido



REF	Ø BARRA POLE TRINGLE	U	€	€	cm
45335-1211	19	50	0,62 €		
45335-1111	30	50	0,92 €		

*Hasta fin de existencias / Until the end of stocks / Jusqu'a la fin de stocks

Ollao negro-oro



REF	Ø BARRA POLE TRINGLE	U	€	€	cm
45335-1212	19	50	0,62 €		
45335-1112	30	50	0,92 €		

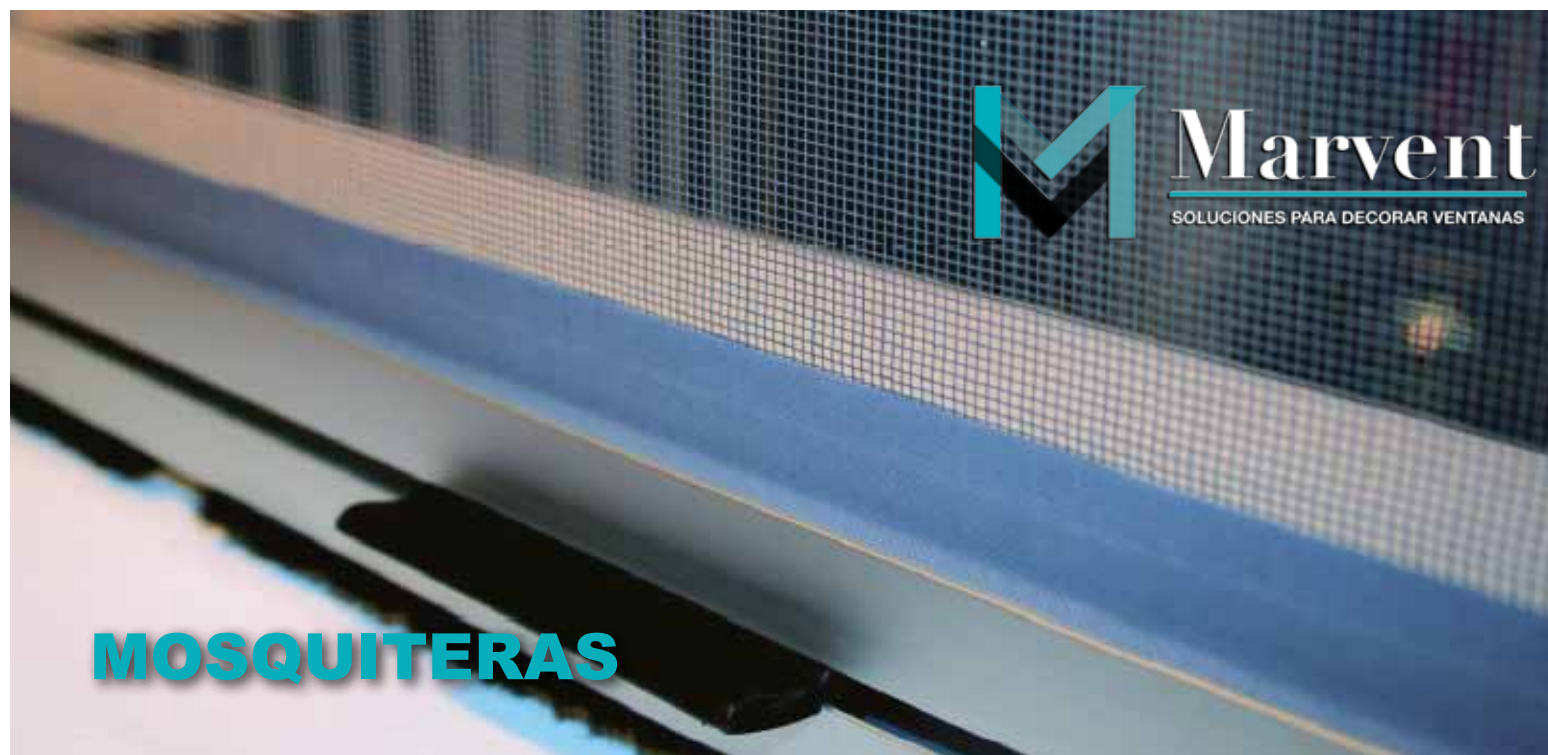

MOSQUITERAS

OLLAOS

Ollaos Latón / Brass Eyelets / Oeillets Laiton - 100%

OLLAOS DE LATÓN PARA BARRAS DE 19 y 30 mm /
 BRASS EYELETS FOR 19 & 30 mm POLE /
 OEILLETES LAITON POUR TRINGLE 19 et 30 mm
 *Es necesario prensa

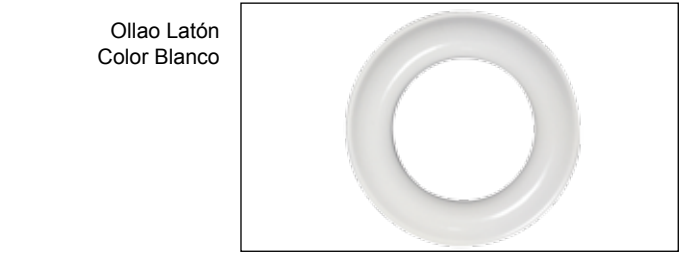
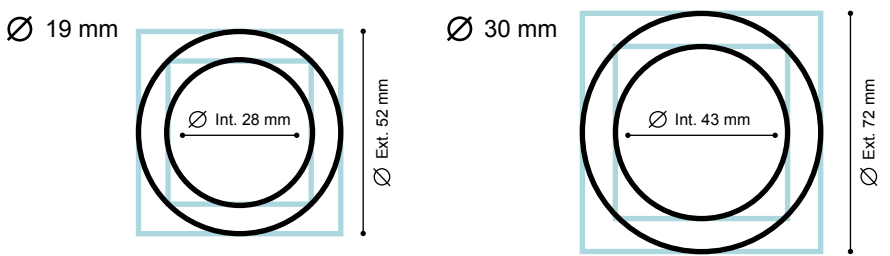

Ollao Latón
Color Blanco

REF	Ø BARRA POLE TRINGLE				
45335-100B	30	50	1,98 €/u		

NEW



Ollao Latón
Color Negro

REF	Ø BARRA POLE TRINGLE				
45335-101N	19	50	1,86 €		
45335-100N	30	50	1,98 €		



Ollao Latón
Color Negro

REF	Ø BARRA POLE TRINGLE				
45335-103N	19	50	1,86 €		
45335-102N	30	50	1,98 €		



Ollao Latón
Color Acero

REF	Ø BARRA POLE TRINGLE				
45335-101A	19	50	1,60 €		
45335-100A	30	50	1,98 €		



Ollao Latón
Color Acero

REF	Ø BARRA POLE TRINGLE				
45335-103A	19	50	1,60 €		
45335-102A	30	50	1,98 €		



Ollao Latón
Color Dorado

REF	Ø BARRA POLE TRINGLE				
45335-101BR	19	50	1,60 €		
45335-100BR	30	50	1,98 €		



Ollao Latón
Color Dorado

REF	Ø BARRA POLE TRINGLE				
45335-103BR	19	50	1,60 €		
45335-102BR	30	50	1,98 €		

Ollaos Latón / Brass Eyelets / Oeillets Laiton - 100%

Ollao Latón
Color Cuero



REF	Ø BARRA POLE TRINGLE	U	€	€	cm
45335-101C	19	50	1,60 €		
45335-100C	30	50	1,98 €		

Ollao Latón
Color Cuero



REF	Ø BARRA POLE TRINGLE	U	€	€	cm
45335-103C	19	50	1,60 €		
45335-102C	30	50	1,98 €		

Ollao Latón
Color Cuero Claro



REF	Ø BARRA POLE TRINGLE	U	€	€	cm
45335-101CC	19	50	1,60 €		
45335-100CC	30	50	1,98 €		

Ollao Latón
Color Cuero Claro



REF	Ø BARRA POLE TRINGLE	U	€	€	cm
45335-103CC	19	50	1,60 €		
45335-102CC	30	50	1,98 €		

Marvent System somos tu empresa profesional de confianza dedicada a ayudarte a decorar tus ventanas. Nuestra experiencia en el sector de la decoración con sistemas técnicos y de alta calidad está contrastada y avalada. Contáctate con nosotros sin compromiso.

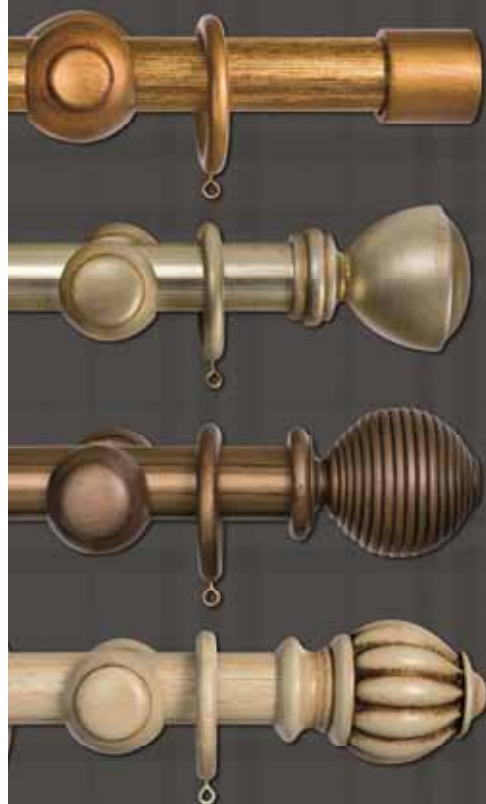

barras de cortina
paneles japoneses
estores
rieles
motorizados
galerías
accesorios
ollaos

Calle Valladolid, Nave 39-3 - 18151 Ogijares - Granada - Spain
Tel: +34 958 50 38 20 - administracion@marvent.es



nueva colección



BELMONTE
tu barra de cortina vintage en madera

OLLAOS

Ollaos de Plástico MANUALES / Plastic SELF-LOCK Manual Eyelets / Oeillet MANUEL en Plastic - 100%

OLLAOS DE PLÁSTICO MANUAL (Sin prensa) PARA BARRA DE 30 mm /
 MANUAL PLASTIC EYELET FOR 30 mm POLE /
 OEILLET MANUEL EN PLASTIC POUR TRINGLE 30 mm

∅ 30 mm

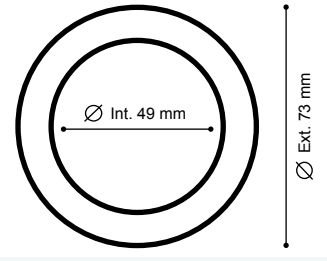

Ollao Plástico Manual Color Transparente		<table border="1"> <thead> <tr> <th>REF</th> <th>∅ BARRA POLE TRINGLE</th> <th></th> <th></th> <th></th> <th></th> <th rowspan="2">NEW</th> </tr> </thead> <tbody> <tr> <td>45335-1301</td> <td>30</td> <td>100</td> <td>0,48 €</td> <td></td> <td></td> </tr> </tbody> </table>	REF	∅ BARRA POLE TRINGLE					NEW	45335-1301	30	100	0,48 €		
REF	∅ BARRA POLE TRINGLE					NEW									
45335-1301	30	100	0,48 €												
Ollao Plástico Manual Color Blanco		<table border="1"> <thead> <tr> <th>REF</th> <th>∅ BARRA POLE TRINGLE</th> <th></th> <th></th> <th></th> <th></th> <th rowspan="2">NEW</th> </tr> </thead> <tbody> <tr> <td>45335-1302</td> <td>30</td> <td>100</td> <td>0,48 €</td> <td></td> <td></td> </tr> </tbody> </table>	REF	∅ BARRA POLE TRINGLE					NEW	45335-1302	30	100	0,48 €		
REF	∅ BARRA POLE TRINGLE					NEW									
45335-1302	30	100	0,48 €												
Ollao Plástico Manual Color Negro		<table border="1"> <thead> <tr> <th>REF</th> <th>∅ BARRA POLE TRINGLE</th> <th></th> <th></th> <th></th> <th></th> <th rowspan="2">NEW</th> </tr> </thead> <tbody> <tr> <td>45335-1303</td> <td>30</td> <td>100</td> <td>0,48 €</td> <td></td> <td></td> </tr> </tbody> </table>	REF	∅ BARRA POLE TRINGLE					NEW	45335-1303	30	100	0,48 €		
REF	∅ BARRA POLE TRINGLE					NEW									
45335-1303	30	100	0,48 €												
Ollao Plástico Manual Color Plata Mate		<table border="1"> <thead> <tr> <th>REF</th> <th>∅ BARRA POLE TRINGLE</th> <th></th> <th></th> <th></th> <th></th> <th rowspan="2">NEW</th> </tr> </thead> <tbody> <tr> <td>45335-1307</td> <td>30</td> <td>100</td> <td>0,48 €</td> <td></td> <td></td> </tr> </tbody> </table>	REF	∅ BARRA POLE TRINGLE					NEW	45335-1307	30	100	0,48 €		
REF	∅ BARRA POLE TRINGLE					NEW									
45335-1307	30	100	0,48 €												
Ollao Plástico Manual Color Oro Mate		<table border="1"> <thead> <tr> <th>REF</th> <th>∅ BARRA POLE TRINGLE</th> <th></th> <th></th> <th></th> <th></th> <th rowspan="2">NEW</th> </tr> </thead> <tbody> <tr> <td>45335-1308</td> <td>30</td> <td>100</td> <td>0,48 €</td> <td></td> <td></td> </tr> </tbody> </table>	REF	∅ BARRA POLE TRINGLE					NEW	45335-1308	30	100	0,48 €		
REF	∅ BARRA POLE TRINGLE					NEW									
45335-1308	30	100	0,48 €												
Ollao Plástico Manual Color Beige		<table border="1"> <thead> <tr> <th>REF</th> <th>∅ BARRA POLE TRINGLE</th> <th></th> <th></th> <th></th> <th></th> <th rowspan="2">NEW</th> </tr> </thead> <tbody> <tr> <td>45335-1313</td> <td>30</td> <td>100</td> <td>0,48 €</td> <td></td> <td></td> </tr> </tbody> </table>	REF	∅ BARRA POLE TRINGLE					NEW	45335-1313	30	100	0,48 €		
REF	∅ BARRA POLE TRINGLE					NEW									
45335-1313	30	100	0,48 €												
Ollao Plástico Manual Color Marrón		<table border="1"> <thead> <tr> <th>REF</th> <th>∅ BARRA POLE TRINGLE</th> <th></th> <th></th> <th></th> <th></th> <th rowspan="2">NEW</th> </tr> </thead> <tbody> <tr> <td>45335-1314</td> <td>30</td> <td>100</td> <td>0,48 €</td> <td></td> <td></td> </tr> </tbody> </table>	REF	∅ BARRA POLE TRINGLE					NEW	45335-1314	30	100	0,48 €		
REF	∅ BARRA POLE TRINGLE					NEW									
45335-1314	30	100	0,48 €												

Ollaos de Plástico MANUALES / Plastic SELF-LOCK Manual Eyelets / Oeillet MANUEL en Plastic - 100%

Ollao Plástico Manual
Color Gris Metálico



REF	Ø BARRA POLE TRINGLE	U	€	1	cm	NEW
45335-1315	30	100	0,48 €			

Ollao Plástico Manual
Color Cuero Mate

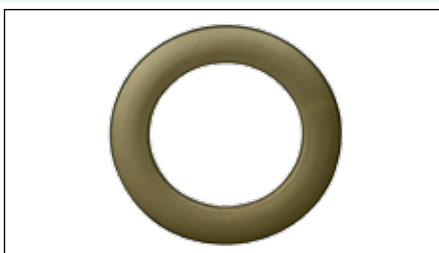

REF	Ø BARRA POLE TRINGLE	U	€	1	cm	NEW
45335-1316	30	100	0,48 €			

Ollao Plástico Manual
Color Níquel



REF	Ø BARRA POLE TRINGLE	U	€	1	cm	NEW
45335-1317	30	100	0,48 €			

Ollao Plástico Manual
Color Latón Brillo



REF	Ø BARRA POLE TRINGLE	U	€	1	cm	NEW
45335-1318	30	100	0,48 €			



CORTINA VENECIANA DE MADERA

Protección solar creando zonas cálidas y confortables, embelleciendo el ambiente y dándole un toque personal a tu casa.



Accesorios para Ollaos / Eyelets Accessories / Accessoires pour Oeilletes

Prensa para ollaos



REF	∅	U	€	1	cm
45335-H104		1	524,00 €		

Juego matricería completo para Ollaos de Latón (43/28 mm)



REF	∅	U	€	1	cm
45335-H105		1	291,80 €		

Juego remachador para Ollaos de Latón (43/28 mm)



REF	∅	BARRA POLE TRINGLE	U	€	1	cm
45335-H107	19		1	49,00 €		
45335-H106	30		1	49,00 €		

Juego cortador para Ollaos de Latón



REF	∅	BARRA POLE TRINGLE	U	€	1	cm
45335-H109	19		1	89,76 €		
45335-H108	30		1	104,04 €		

Juego matricería completo para Ollaos de Policarbonato (40/25 mm)



REF	∅	U	€	1	cm
45335-H111		1	395,36 €		

Juego matricería para Ollaos de Policarbonato (40/25 mm)



REF	∅	BARRA POLE TRINGLE	U	€	1	cm
45335-H113	19		1	171,36 €		
45335-H112	30		1	224,00 €		

Muestra de Ollaos

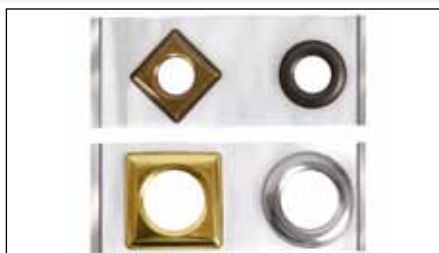

REF	∅	U	€	1	cm
45335-M106		1	15,00 €		



 Soportes Rápidos de “quita y pon”, para ventanas y/o puertas de aluminio que no requieren taladrar ni el uso de tornillos de fijación.

Hay dos modelos para sujeción por su parte Superior o Frontal.

Además se sirve en dos acabados: blanco y gris.

 “Quick” brackets for instant installation on pvc or aluminium windows or doors. No drilling nor fixing screws.

Two models available either for ceiling or face fixing.

Also two colours are offered: white and grey.

 Supports express “pose et quitte” pour fenêtres ou portes en aluminium qui ne peuvent pas être perforées.

2 modèles différents sont proposés: fixation sur la partie supérieur ou de face.

De plus, ils sont disponibles en blanc et gris.

Componentes / Components / Composants

BL GR

Soporte parte Frontal Blanco

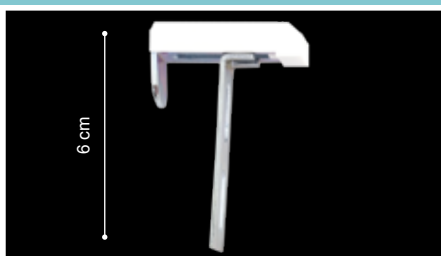

REF	∅	U	€	€	cm
90609-138BL		100	5,60 €	6,44 €	

Soporte parte Frontal Gris



REF	∅	U	€	€	cm
90609-138GR		100	5,60 €	6,44 €	

Soporte parte Superior Blanco



REF	∅	U	€	€	cm
90609-137BL		100	6,20 €	7,13 €	

Soporte parte Superior Gris

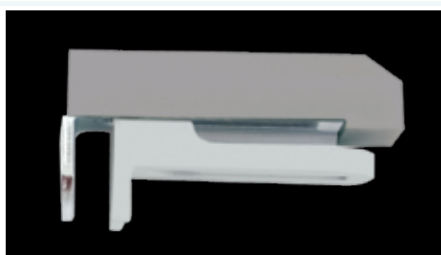

REF	∅	U	€	€	cm
90609-137GR		100	6,20 €	7,13 €	

Accesorios / Accessories / Accessoires

Deslizadores



REF	∅	U	€	€	cm
45335-H919	19	100	0,34 €	0,39 €	
45335-H919	30	100	0,34 €	0,34 €	

CORTINAS ENROLLABLES

Ponemos a disposición de nuestros clientes una amplia gama de tejidos técnicos para cortinas enrollables. Solicite catálogos y tarifas.

Marvent
SOLUCIONES PARA DECORAR VENTANAS

CONTRAPESOS

Contrapesos / Cordweight / Contrepoids

Contrapeso Latón con protector Pequeño Plata

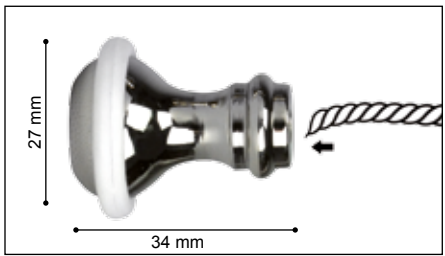

REF	∅	U	€	€	cm	NEW
04332-1187PL		25	4,54 €	5,22 €		

Contrapeso Latón con protector Pequeño Pulido

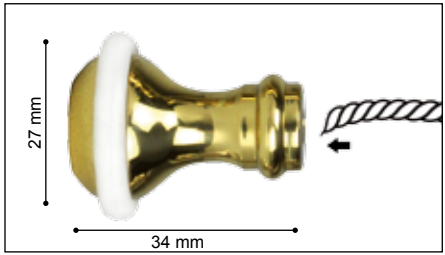

REF	∅	U	€	€	cm	NEW
04332-1187PU		25	3,80 €	4,37 €		

Contrapeso Latón con protector Grande Plata

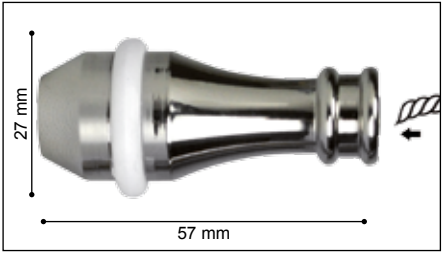

REF	∅	U	€	€	cm	NEW
04332-1189PL		25	5,78 €	6,65 €		

Contrapeso Latón con protector Grande Pulido

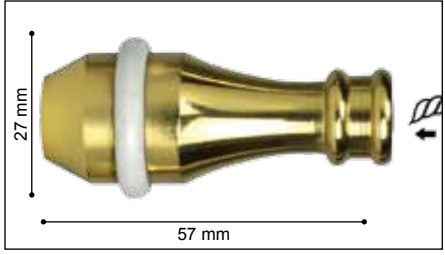

REF	∅	U	€	€	cm	NEW
04332-1189PU		25	4,82 €	5,54 €		





Marvent
MARVENT SYSTEM S.L.

Marvent System, S.L

POLÍGONO TECNOLÓGICO OGÍJARES
C/ VALLADOLID, NAVE 39.3

TLF: 958 50 38 20 - FAX: 958 50 69 18
18015 OGÍJARES (GRANADA)

662 494 403 . administracion@marvent.es

www.marvent.es